 www.khadamathydraulic.com
 Tell: 021-55882749
 Tell: 021-33488178
 Fax: 021-33488105

Features:

- Direct solenoid actuated directional spool valve
- Wet pin DC or AC solenoids



Function, section

Directional valves of type WE5 are solenoid operated directional spool valves. They control the start, stop and direction of a fluid flow.

These directional valves basically consist of the housing (1), one or two solenoids (2), the control spool (3), and one or two return springs(4).

The control spool (3) is held by the return spring (4) in the central or in the initial position (except for detented spools). The control spool (3) is actuated via wet pin solenoids (2). In the energized condition. The force of the solenoid (2) acts via the plunger (5) on the control spool (3) and shifts the same from its rest position to the desired end position. Thus, the required flow pattern from P to A and B to T or P to B and A to T is selected. When the solenoid (2) is de-energized, the control spool (3) is returned to its neutral position by the return spring (4). A covered manual override is provided so that the control spool (3) can be operated without energizing the solenoid.

Type 4WE5 N 6.0B/O...

This version is a directional valve with 2 switching positions and 2 solenoids without detent and springs. There is no defined switching position in the de-energized condition.

Type 4WE5 N 6.0B/OF...

This version is a directional valve with 2 switching position, 2 solenoids and a detent. Thus, the relevant switching positions are fixed and continuous energization of the solenoid is not necessary

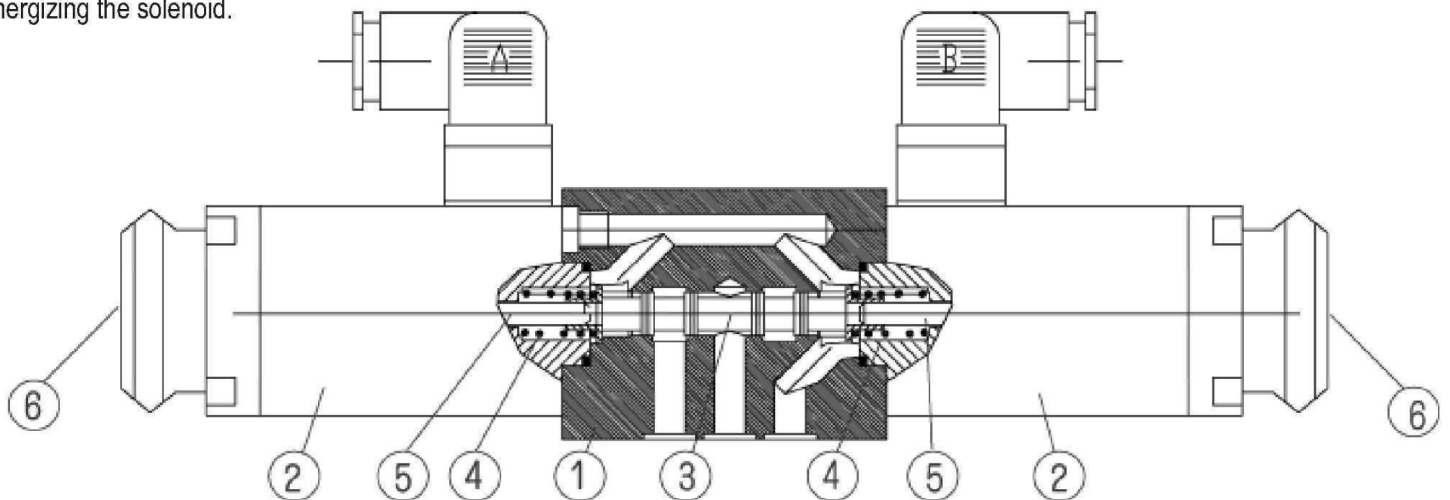

Type WE5

Ordering details

WE 5 6.0 / A *

3 Service ports = 3
4 Service ports = 4

Nominal size 5 = 5

Further details in cleartext

No code = mineral oils
V = phosphate ester

z4= plug-in connector
z5= large plug-in connector
z5L=large plug-in connector with indicator

N= With manual override
No = Without manual override

W220-50= 220 V AC 50 Hz
G24= 24 V DC
W220R = DC solenoid commuting automatically

A= wet pin solenoid

No= Standard, with spring return
OF= Without spring return, with detent
O = Without spring return

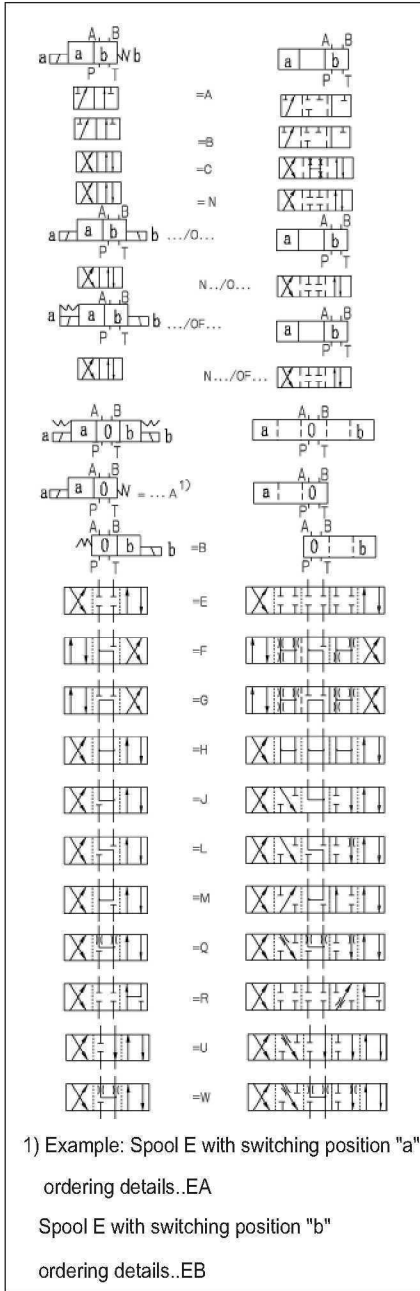

Series 6.0 to 6.9 = 6.0
(6.0 to 6.9: unchanged installation and connection dimensions)

* With spool types A and B port T must be used as a drain port when operating pressure exceeds 6 MPa

Technical data

Hydraulic			
Hydraulic fluid	mineral oils , phosphate ester		
Fluid temperature range (°C)	-30 ~ +80		
Viscosity range (mm ² /s)	2.8 ~ 500		
Operating pressure, max. (MPa)	Port A, B, P		Port T
	up to 25		up to 6
Flow area (switching position 0):	With symbol W		With symbol Q
	approx. 3% of nominal cross section		approx. 6% of nominal cross section
Weight (kg)	valve	subplate G115/01	subplate G96/01
	approx.1.4	approx.0.7	approx.0.5
Electrical			
AC Voltage (V)	110, 220, in 50Hz		
DC Voltage (V)	12, 24, 110		
Voltage type	AC	DC	
Power requirement (W)	26		
Holding power (VA)	-	46	
Switch-on power (VA)	-	130	
Duty cycle	continue		
Switching time	ON (ms)	40	25
	OFF (ms)	30	20
Environment temperature (°C)	+50		
Coil temperature (°C)	+150		
Switching frequency cycles (cycles /h)	15000	7200	
Type of protection to DIN 40 050	IP65		

Switching limits

Attention!

The given operating limits are valid for the use with two flow directions (e.g. from P to A and simultaneous return flow from B to T). Due to the flow forces active inside the valves the permissible operating limit may be significantly lower if only one flow direction from P to A and closed port B) is used! The operating limits were measured with solenoids at operating temperature, 10% under voltage and without tank back pressure.

symbol	flow in L/min	operating pressure in MPa		
		5	10	25
A, B, C, N, E, F, H, J, L, M, Q, R, V, W		14	14	12
G		10	10	9

Characteristic curves (measured at $v = 41 \text{ mm}^2/\text{s}$ and $t = 50 \text{ }^\circ\text{C}$)

- symbol B
- - - - - symbol R
- symbol others

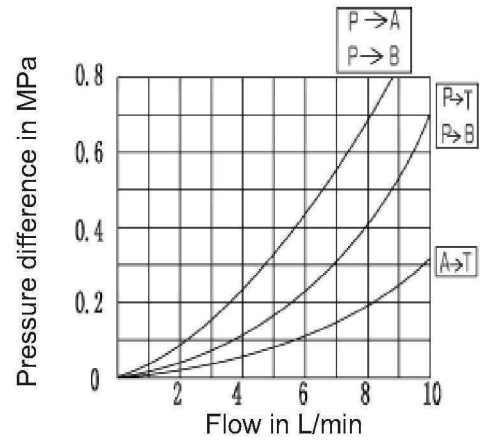
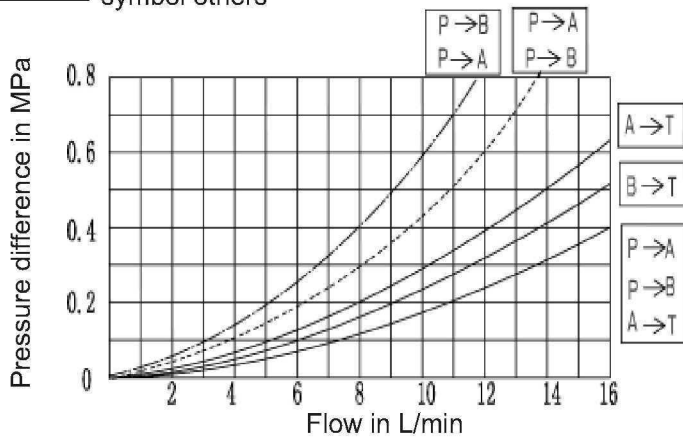

Unit dimensions

(Dimensions in mm)

Shape and connection dimensions of 3-position valve.

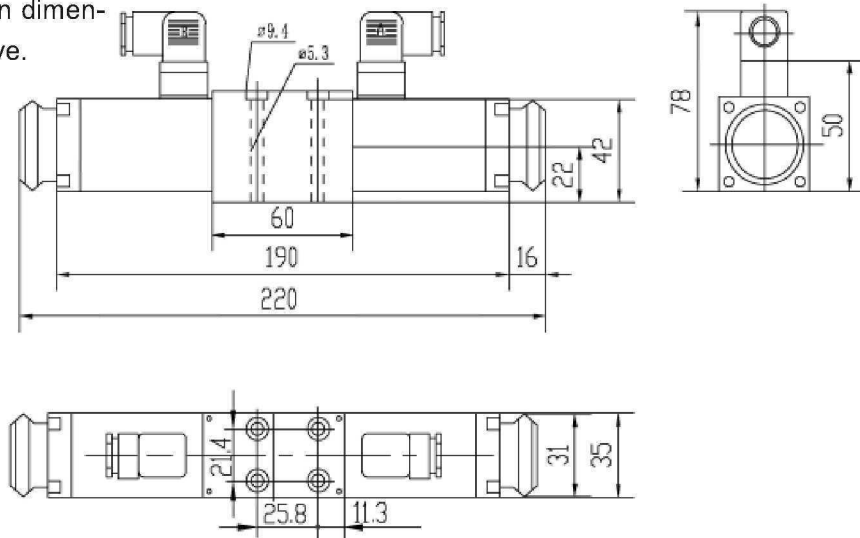

Shape and connection dimensions of 2-position valve.

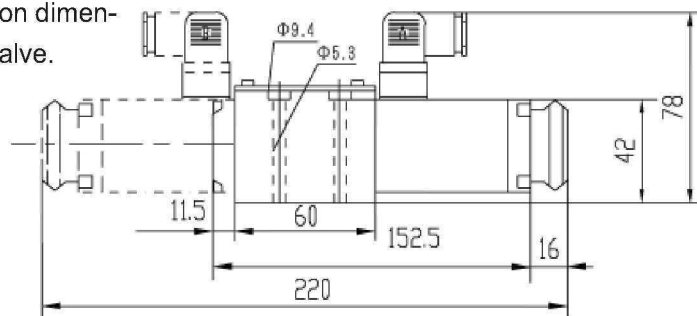

Required surface finish of mating piece

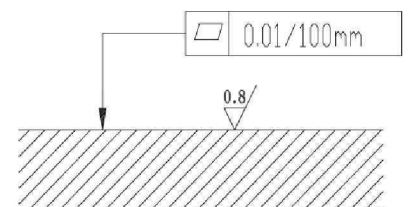

The connection dimensions of service ports

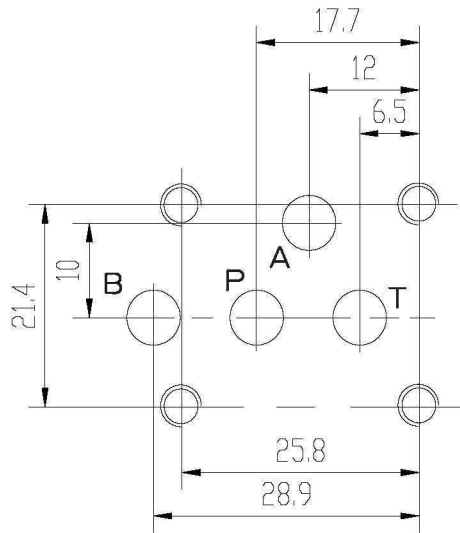

O-ring	7X1.5
Valve fixing screws	4-M5X50-10.9 (GB/T70.1-2000) M _A =9N.m

Subplates:

G115/01; G96/01

G115/02; G96/02

see page 212

Dimensions of the electrical connection

(Dimension in mm)

z4 plug-in connector

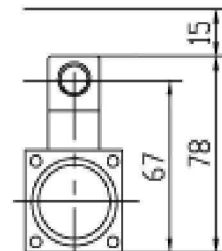
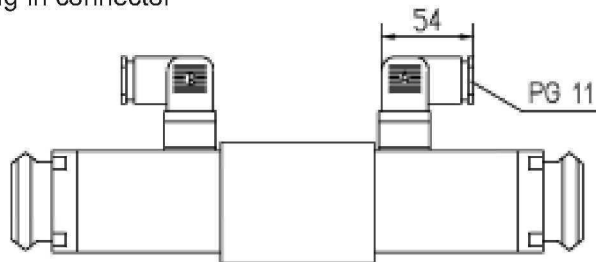

z5 large plug-in connector

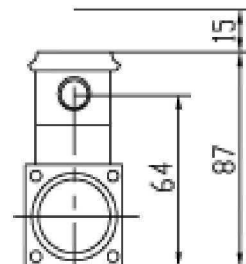
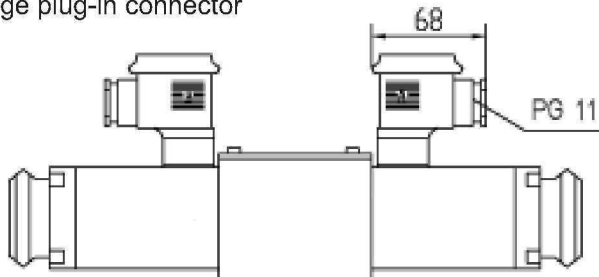

z5L large plug-in connector with indicator

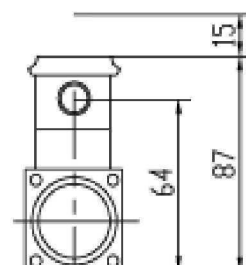
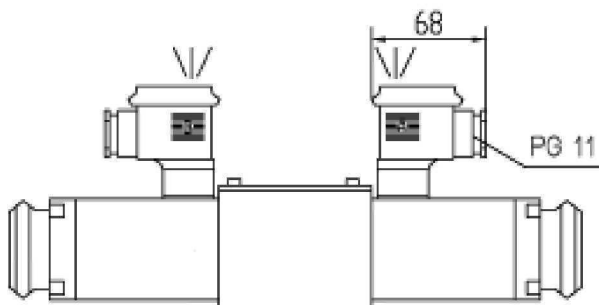

Notice

1. The fluid must be filtered. Minimum filter fineness is 20 μm .
2. The tank must be sealing up and an air filter must be installed on air entrance.
3. Products without subplate when leaving factory, if need them, please ordering specially.
4. Valve fixing screws must be high intensity level (class 10.9). Please select and use them according to the parameter listed in the sample book.
5. Roughness of surface linked with the valve is required to $\frac{0.8}{\nabla}$.
6. Surface finish of mating piece is required to 0.01/100mm.