

**Characteristics**

The D1VL is a 3 chamber, D3DL, D4L and D9L are 5 chamber 4/3- or 4/2-way directional control valves.

The hand lever is directly connected to the spool and can be located either on the A or B side. Spring offset and detent designs are available.

Directional control valves with hand lever are available in 4 sizes:

- D1VL NG06
- D3DL NG10
- D4L NG16
- D9L NG25

 [www.khadamathydraulic.com](http://www.khadamathydraulic.com)  
 Tell: 021-55882749  
 Tell: 021-33488178  
 Fax: 021-33488105



D1VL

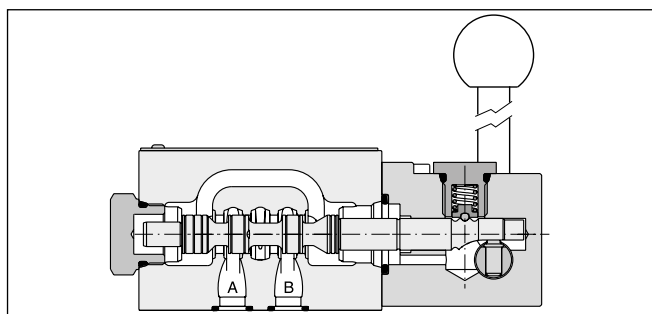
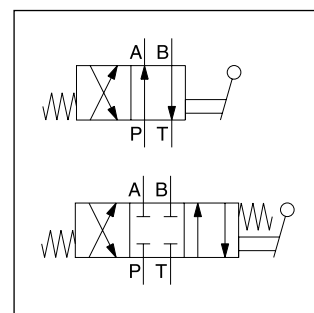

D1VL

**Features**

- All hand lever parts stainless steel

**Technical data**

General					
Design	Directional spool valve				
Actuation	Lever				
Series	<b>D1VL</b>	<b>D3DL</b>	<b>D4L</b>	<b>D9L</b>	
Size	NG06	NG10	NG16	NG25	
Weight [kg]	1.4	3.7	9.0	17.0	
Mounting interface	DIN 24340 A06	DIN 24340 A10	DIN 24340 A16	DIN 24340 A25	
	ISO 4401	ISO 4401	ISO 4401	ISO 4401	
	NFPA D03	NFPA D05	NFPA D07	NFPA D08	
CETOP RP 121-H					
Mounting position	unrestricted, preferably horizontal				
Ambient temperature [°C]	-25...+60				
MTTF <sub>p</sub> value [years]	150				
Hydraulic					
Max. operating pressure [bar]	P, A B: 350; T: 140	P, A B: 350; T: 140	external drain	external drain	
			P, A B, T: 350; X, Y: 140	P, A B, T: 350; X, Y: 140	
Fluid	Hydraulic oil according to DIN 51524	internal drain	P, A B: 350; T, X, Y: 140	internal drain	
			P, A B: 350; T, X, Y: 140	P, A B: 350; T, X, Y: 140	
Fluid temperature [°C]	-20 ... +70 (NBR: -25...+70)				
Viscosity permitted [cSt] / [mm <sup>2</sup> /s]	2.8...400				
Viscosity recommended [cSt] / [mm <sup>2</sup> /s]	30...80				
Filtration	ISO 4406 (1999); 18/16/13				
Flow max. [l/min]	80	130	300	700	
Leakage at 350 bar (per flow path) [ml/min]	–	up to 100 <sup>1)</sup>	up to 200 <sup>1)</sup>	up to 800 <sup>1)</sup>	
Leakage at 50 bar (per flow path) [ml/min]	up to 10 <sup>1)</sup>	–	–	–	

<sup>1)</sup> Depending on spool.

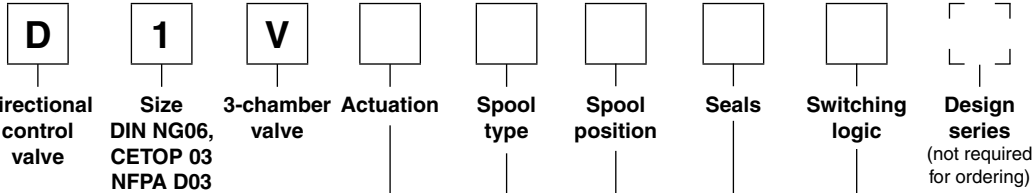

**2**

Code	Actuation
L	Hand lever side B 
LB	Hand lever side A 

Code	Switching logic
4J <sup>2)</sup>	Center of rotation below spool axis (Parker style)
4K <sup>2)</sup>	Center of rotation above spool axis (Denison style)

3 position spools	
Code	Spool type
001	a 0 b
002	
004	
006	
009 <sup>1)</sup>	
010 <sup>2)</sup>	
042 <sup>3)</sup>	

2 position spools	
Code	Spool type
020	a b

3 position spools		
Code	Spool position	
C		<b>3 positions.</b> Spring offset in position "0". Operated in position "a" or "b".
	Standard	Spool type 009
E		2 positions. Spring offset in position "0".
K		2 positions. Spring offset in position "0".
N		3 positions, detent. Operated in position "a", "0" or "b".
R		2 positions, detent. Operated in position "0" or "b".
S		2 positions, detent. Operated in position "0" or "a". No center in offset position.

2 position spools		
Code	Spool position	
B		<b>Spring offset in position "b".</b> <b>Operated in position "a".</b>
D		Detent, operated in position "a" or "b". No center or offset position.
H		Spring offset in position "a". Operated in position "b".

Code	Seals
N	NBR
V	FPM

<sup>1)</sup> Consider specific spool position.  
<sup>2)</sup> Only for D3DL.  
<sup>3)</sup> Only for D1VL.

**Bold letters =**  
**Short-term availability**

Further spool types on request.



2

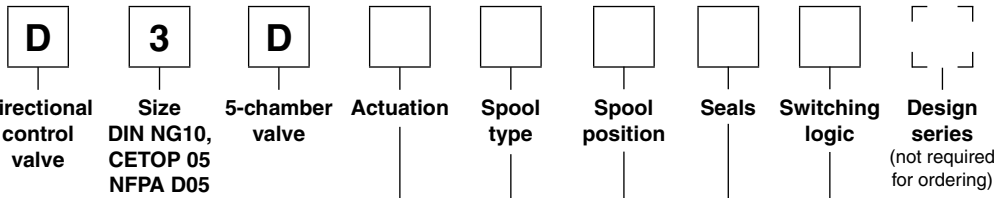

Code	Actuation
L	Hand lever side B 
LB	Hand lever side A 

Code	Switching logic
4J <sup>2)</sup>	Center of rotation below spool axis (Parker style)
4K <sup>2)</sup>	Center of rotation above spool axis (Denison style)

3 position spools	
Code	Spool type
	a 0 b
001	
002	
004	
006	
009 <sup>1)</sup>	
010	

2 position spools	
Code	Spool type
	a b
020	

3 position spools		
Code	Spool position	
C		<b>3 positions.</b> Spring offset in position "0". Operated in position "a" or "b".
	Standard	Spool type 009
E		2 positions. Spring offset in position "0".
	Operated in position "a".	Operated in position "b".
K		2 positions. Spring offset in position "0".
	Operated in position "b".	Operated in position "a".
N		3 positions, detent. Operated in position "a", "0" or "b".
	No centre in offset position.	No centre in offset position.
R		2 positions, detent. Operated in position "0" or "b".
	No centre in offset position.	No centre in offset position.
S		2 positions, detent. Operated in position "0" or "a". No center in offset position.
	No centre in offset position.	No center in offset position.

Code	Seals
N	NBR
V	FPM

2 position spools		
Code	Spool position	
B		Spring offset in position "b". Operated in position "a".
D		Detent, operated in position "a" or "b". No center or offset position.
H		Spring offset in position "a". Operated in position "b".

<sup>1)</sup> Consider specific spool position.  
<sup>2)</sup> Details see dimensions.

**Bold letters =**  
**Short-term availability**

Further spool types on request.

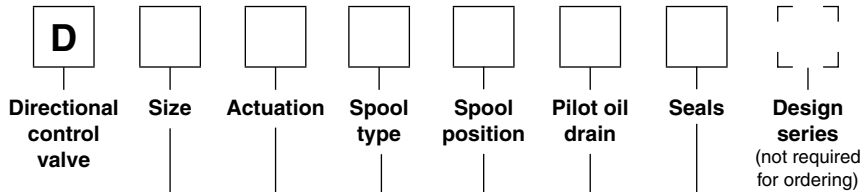

Code	Bore	Size
4	Ø20 mm	NG16
9	Ø32 mm	NG25

Code	Outlet
2 <sup>2)</sup>	External
5 <sup>3)</sup>	Internal

Code	Seals
N	NBR
V	FPM

Code	Actuation	
L	Hand lever side B	
LB	Hand lever side A	

3 position spools			
Code	Spool type	⊘	⊘
001		•	•
002		•	•
003		•	•
004		•	•
006		•	
007		•	•
009 <sup>1)</sup>		•	•
011		•	•
014		•	•
015		•	•

2 position spools			
Code	Spool type	⊘	⊘
020		•	•
030		•	•

3 position spools		
C		3 positions. Spring offset in position "0". Operated in position "a" or "b".
	Standard	Spool type 009
E		2 positions. Spring offset in position "0".
F		2 positions. Spring offset in position "b".
K		2 positions. Spring offset in position "0".
M		2 positions. Spring offset in position "a".
N		3 positions, detent. Operated in position "a", "0" or "b".
R		2 positions, detent. Operated in position "0" or "b".
S		2 positions, detent. Operated in position "0" or "a". No center in offset position.

2 position spools		
B		Spring offset in position "b". Operated in position "a".
D		Detent, operated in position "a" or "b". No center or offset position.
H		Spring offset in position "a". Operated in position "b".

Further spool types on request.

<sup>1)</sup> Consider specific spool position.  
<sup>2)</sup> Pressure T-port > 140 bar.  
<sup>3)</sup> Pressure T-port < 140 bar.

The flow curve diagrams show the flow versus pressure drop curves for all spool types. The relevant curve number

for each spool type, operating position and flow direction is given in the tables below.

**D1VL**

Spool	Position „b“		Position „a“		Position „0“				
	P->A	B->T	P->B	A->T	P->A	P->B	A->T	B->T	P->T
001	2	2	2	2	-	-	-	-	-
002	1	4	1	4	1	1	5	5	2
004	2	3	2	3	-	-	7	7	-
006	1	4	1	4	7	7	-	-	-
020	4	4	2	3	-	-	-	-	-
	P->B	A->T	P->A	B->T	P->A	P->B	A->T	B->T	P->T
009	5	5	6	7	-	-	-	-	7

**Flow curve diagram D1VL**

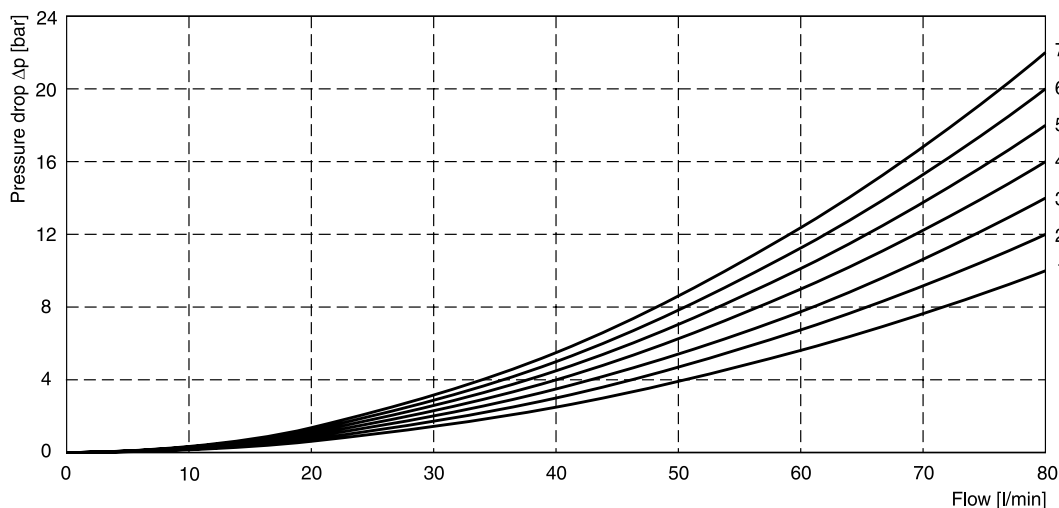

**D3DL**

Spool	Position „b“		Position „a“		Position „0“					
	P-A	B-T	P-B	A-T	P-A	P-B	A-T	B-T	P-T	A-B
001	4	3	4	3	-	-	-	-	-	-
002	2	4	3	3	2	2	1	2	3	4
004	4	3	3	2	-	-	5	5	-	6
006	2	4	3	3	5	5	-	-	-	6
020	4	4	4	4	-	-	-	-	-	-
	P-B	A-T	P-A	B-T	P-A	P-B	A-T	B-T	P-T	A-B
009	2	5	2	6	-	-	-	-	7	-

**Flow curve diagram D3DL**

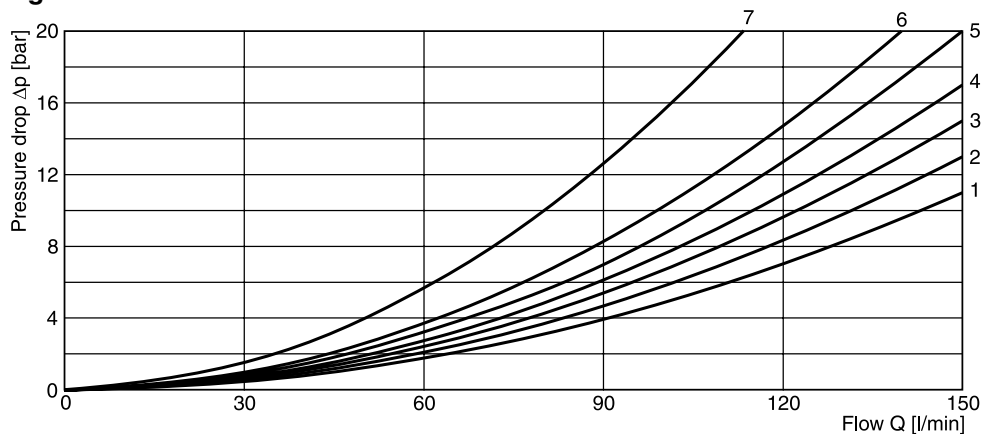

All characteristic curves measured with HLP46 at 50 °C.

The flow curve diagrams show the flow versus pressure drop curves for all spool types. The relevant curve number

for each spool type, operating position and flow direction is given in the tables below.

**D4L**

Spool	Curve number				
	P-A	P-B	P-T	A-T	B-T
001	1	1	-	4	5
002	1	2	6	4	6
003	1	2	-	5	6
004	1	1	-	5	5
006	1	2	-	3	6
007	1	1	6	4	5
009	2	9	8	7	10
011	1	1	-	4	5
014	1	1	6	5	4
015	2	1	-	6	5
020	3	5	-	3	5
030	2	3	-	6	7

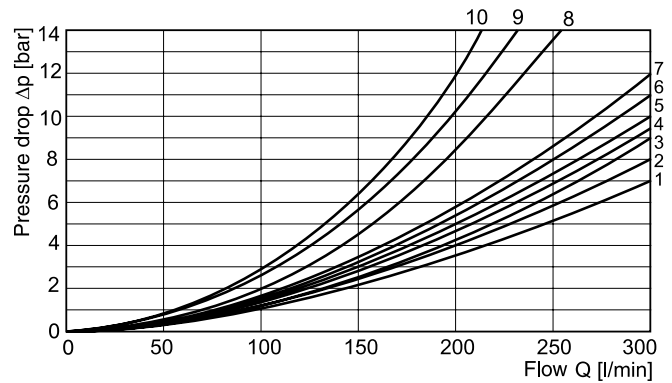

**D9L**

Spool	Curve number				
	P-A	P-B	P-T	A-T	B-T
001	3	2	-	3	5
002	2	1	1	3	5
003	4	2	-	3	6
004	4	3	-	3	5
007	3	1	7	3	5
009	4	8	9	4	10
014	1	3	7	5	3
015	2	4	-	5	3
020	6	5	-	6	8
030	3	2	-	3	5

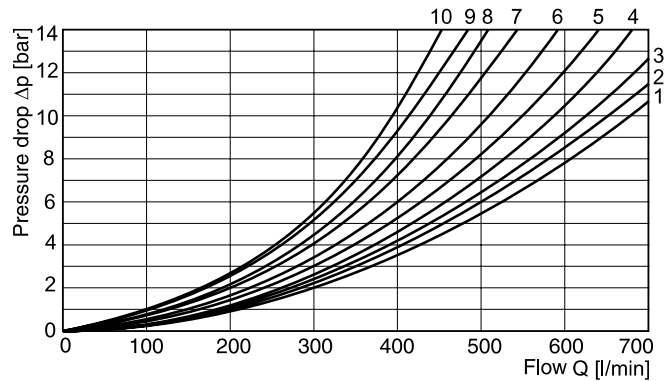

All characteristic curves measured with HLP46 at 50 °C.

**D1VL\*4J**

**2**

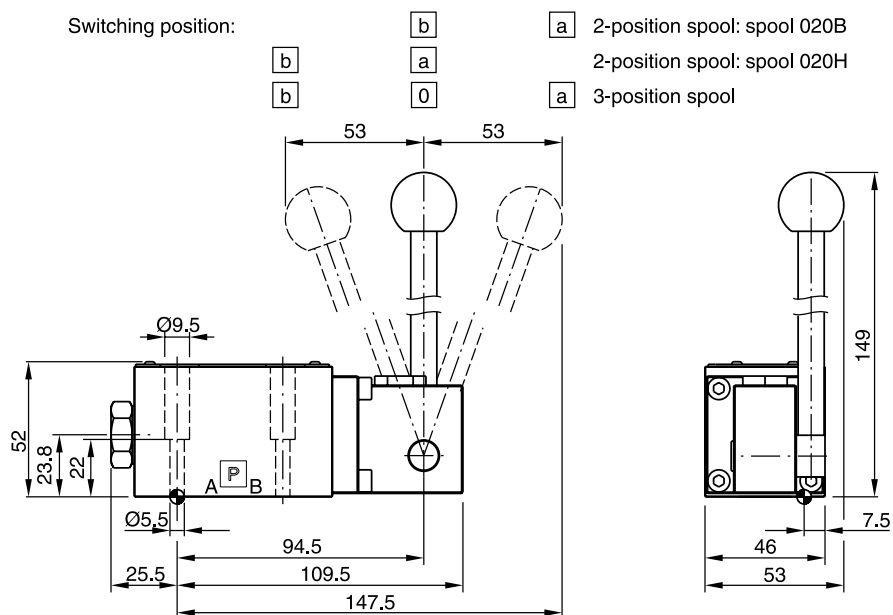

**D1VL\*4K**

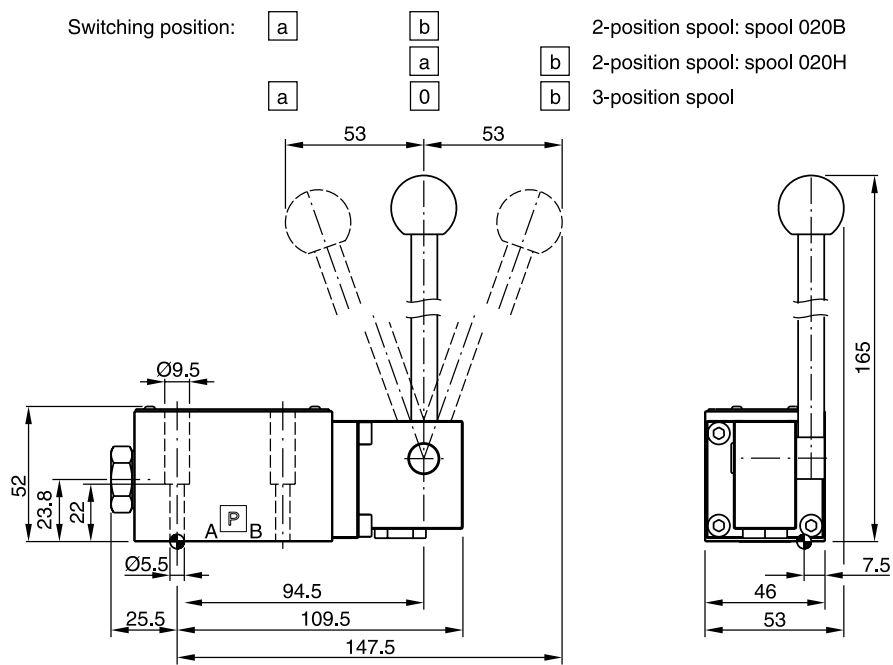

Surface finish	Kit	Kit	Kit	Kit
	BK375	4x M5x30 ISO 4762-12.9	7.6 Nm ±15 %	<b>NBR: SK-D1VL-N-91</b> FPM: SK-D1VL-V-91

Valid for all styles. Switching position see ordering code.

**D1VL\*4J**

Switching position:

- |          |          |          |                              |
|----------|----------|----------|------------------------------|
|          | <b>b</b> | <b>a</b> | 2-position spool: spool 020B |
| <b>b</b> | <b>a</b> |          | 2-position spool: spool 020H |
| <b>b</b> | <b>0</b> | <b>a</b> | 3-position spool             |

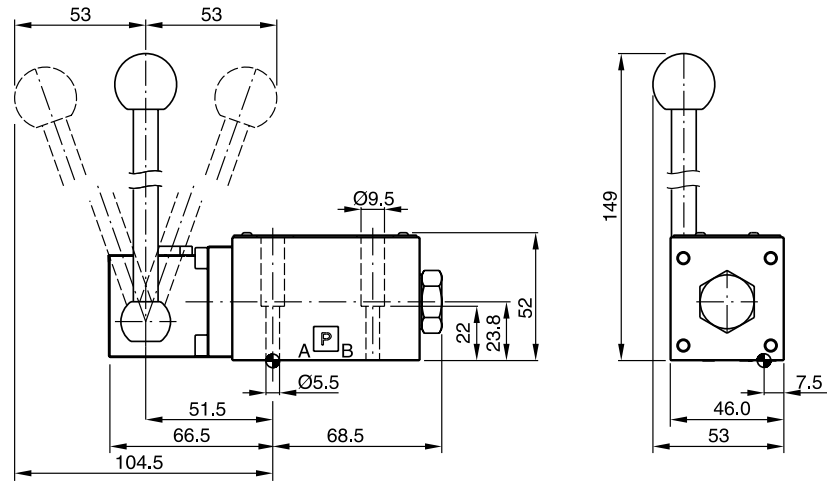

Surface finish	Kit	Kit	Kit	Kit
$\sqrt{R_{max} 6.3}$ $\square 0.01/100$	BK375	4x M5x30 ISO 4762-12.9	7.6 Nm ±15 %	<b>NBR: SK-D1VL-N-91</b> FPM: SK-D1VL-V-91

**D3DL\*4J**

Switching position:

- |          |          |          |                              |
|----------|----------|----------|------------------------------|
|          | <b>b</b> | <b>a</b> | 2-position spool: spool 020B |
| <b>b</b> | <b>a</b> |          | 2-position spool: spool 020H |
| <b>b</b> | <b>0</b> | <b>a</b> | 3-position spool             |

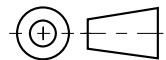
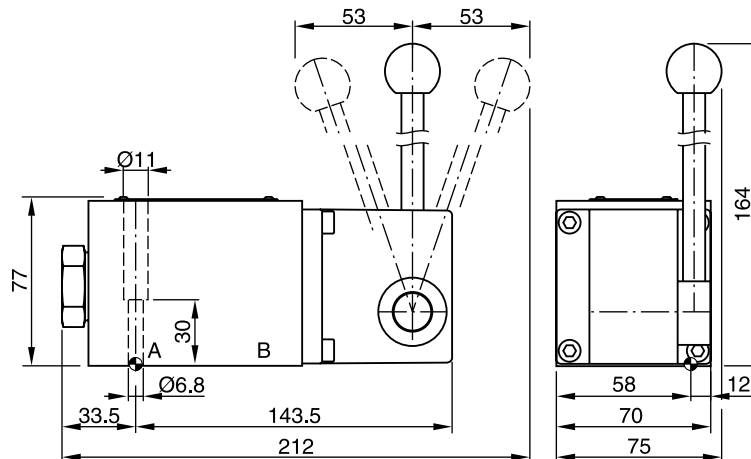

Surface finish	Kit	Kit	Kit	Kit
$\sqrt{R_{max} 6.3}$ $\square 0.01/100$	BK385	4x M6x40 ISO 4762-12.9	13.2 Nm ±15 %	<b>NBR: SK-D3DL-N-42</b> FPM: SK-D3DL-V-42

Valid for all styles. Switching position see ordering code.





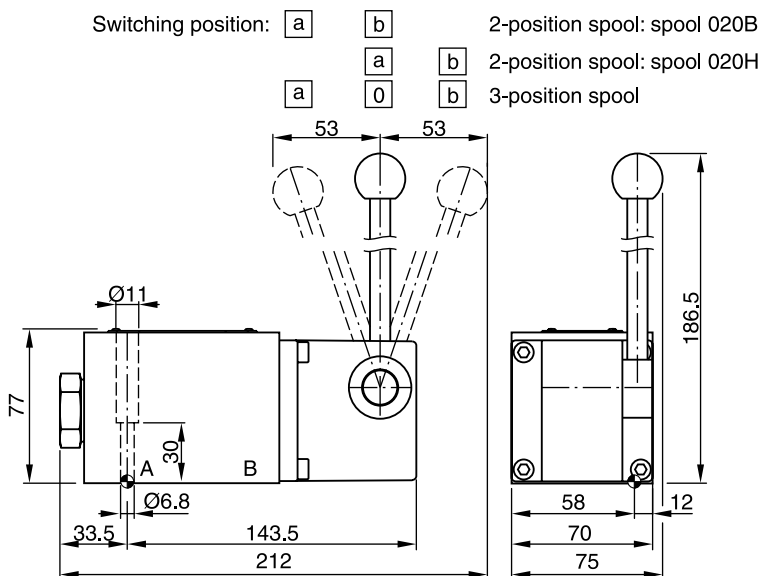

**D3DL\*4K**

**2**

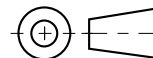
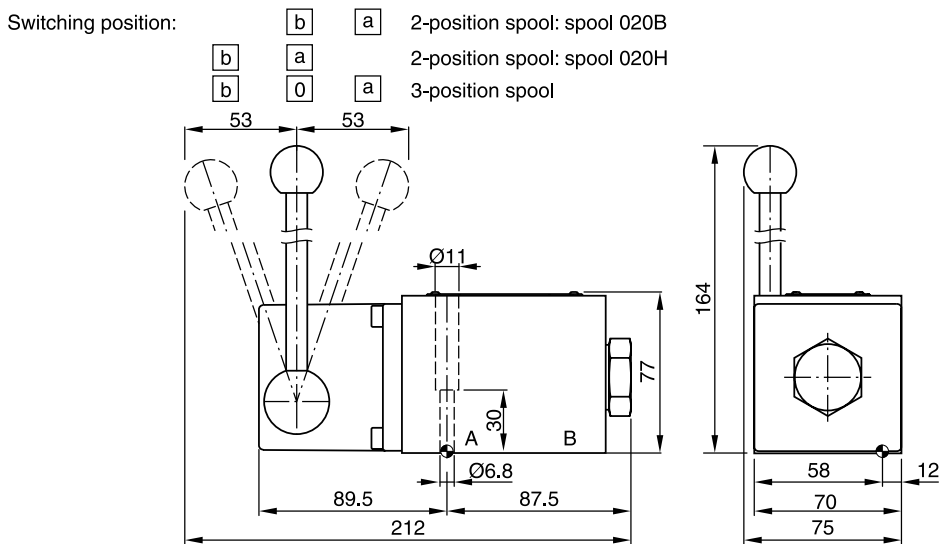

**D3DLB\*4J**

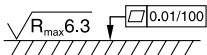

Surface finish	 Kit	 Kit	 Kit	 Kit
	BK385	4x M6x40 ISO 4762-12.9	13.2 Nm ±15 %	<b>NBR: SK-D3DL-N-35</b> FPM: SK-D3DL-V-35

Valid for all styles. Switching position see ordering code.

**D4L**

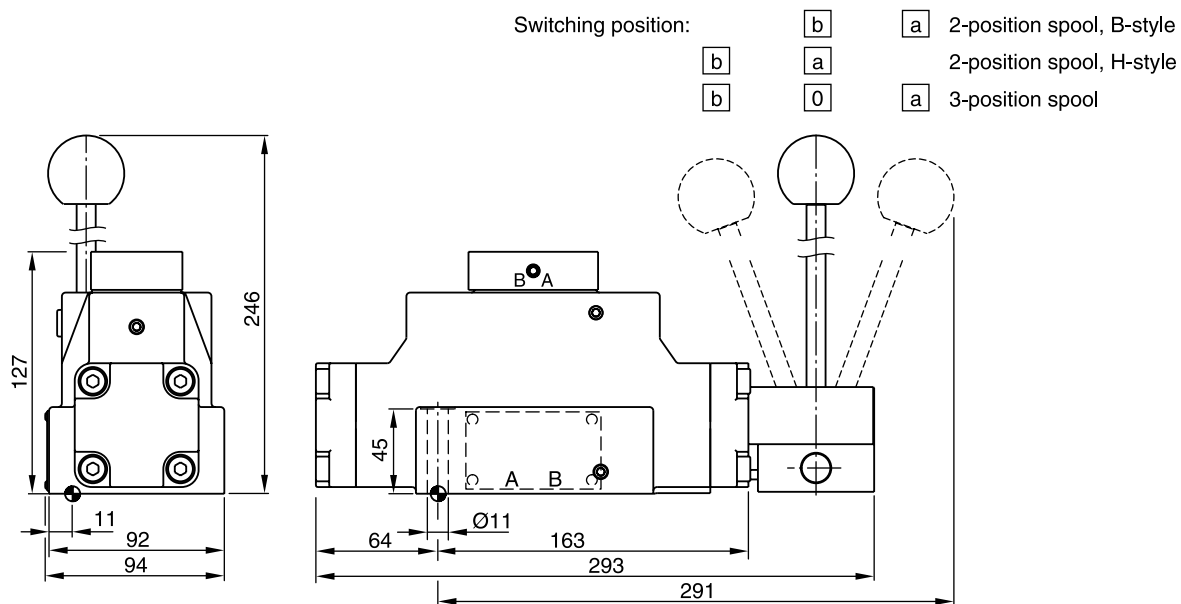

**2**

**D4LB**

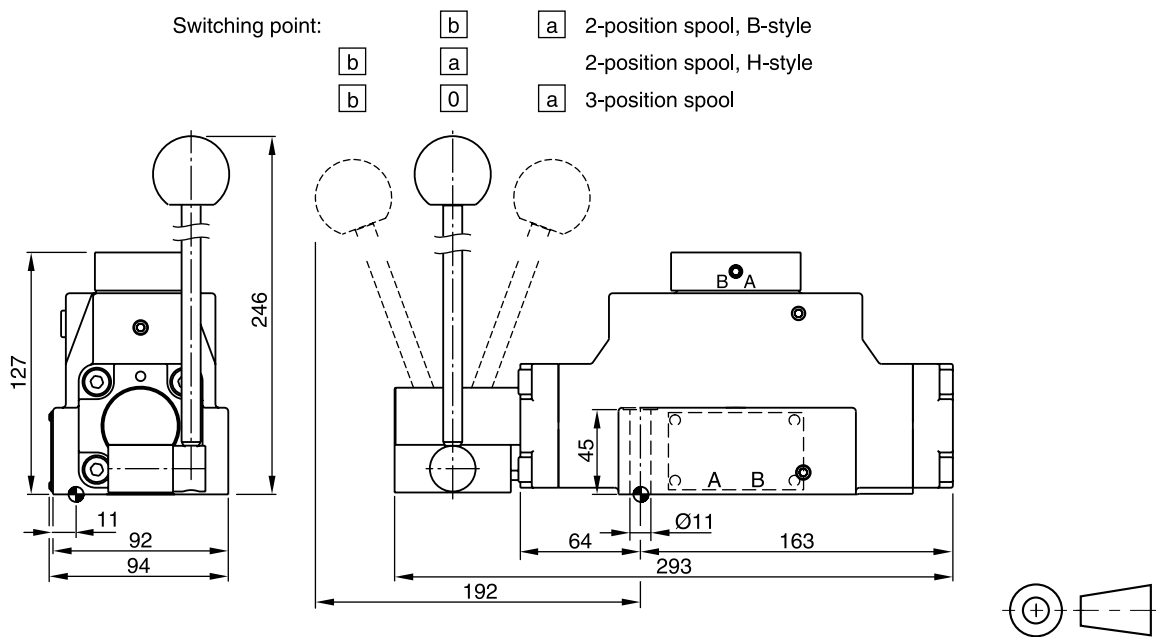

Surface finish	Kit	Kit	Kit	Kit
$\sqrt{R_{Tmax} 6.3}$ $\square 0.01/100$	BK320	4x M10x60 2x M6x55 ISO 4762-12.9	63 Nm 13.2 Nm $\pm 15\%$	<b>NBR: SK-D4L-N-91</b> FPM: SK-D4L-V-91

Valid for all styles. Switching position see ordering code.

**D9L**

**2**

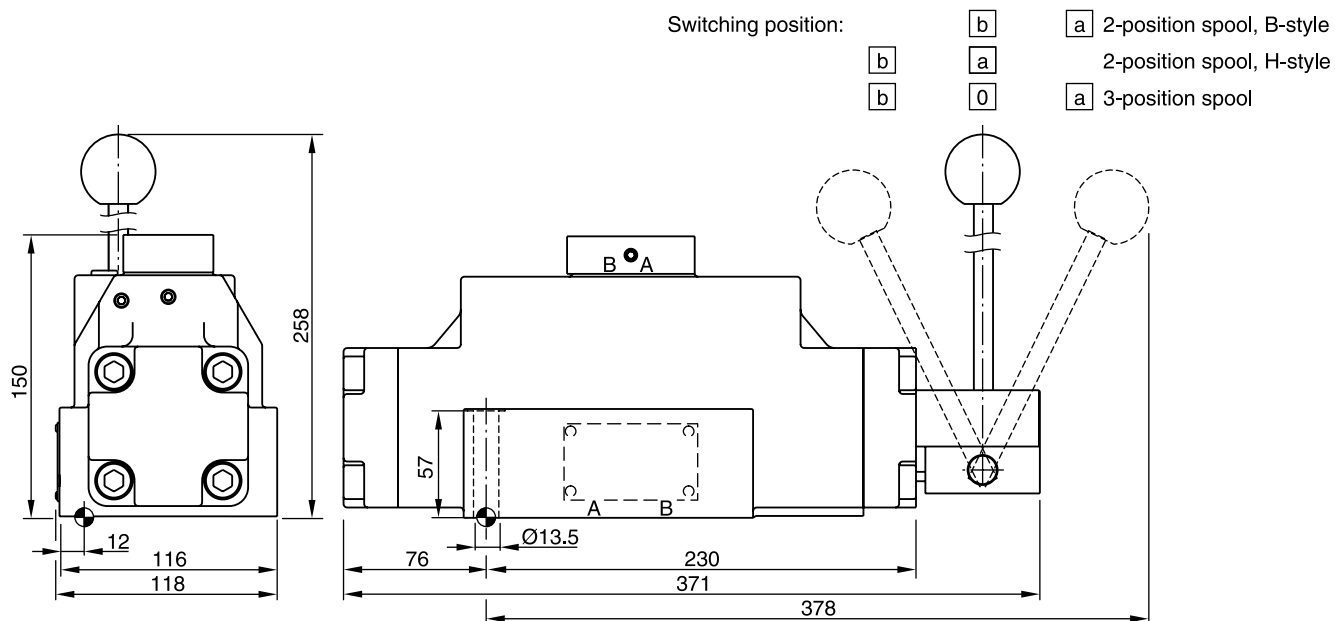

**D9LB**

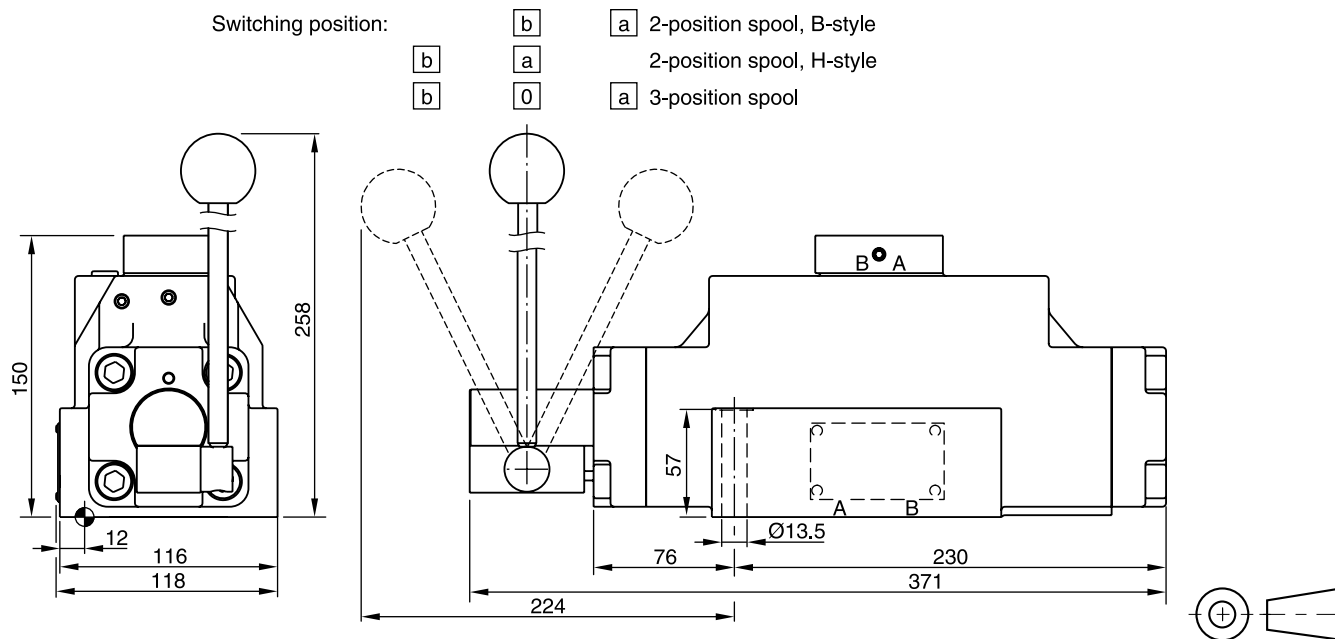

Surface finish	Kit	Wrench	Wrench	Kit
$\sqrt{R_{max} 6.3}$ $\square 0.01/100$	BK360	6x M12x75 ISO 4762-12.9	108 Nm $\pm 15\%$	<b>NBR: SK-D9L-N-91</b> FPM: SK-D9L-V-91

Valid for all styles. Switching position see ordering code.