



Service Manual HY09-SM300/US

 www.khadamathydraulic.com
Tell: 021-55882749
Tell: 021-33488178
Fax: 021-33488105

Service Manual PGP/PGM315, 330, 350, 365

Effective: April 15, 2002
Supersedes: July 1, 1998

PGP/PGM 300 Series

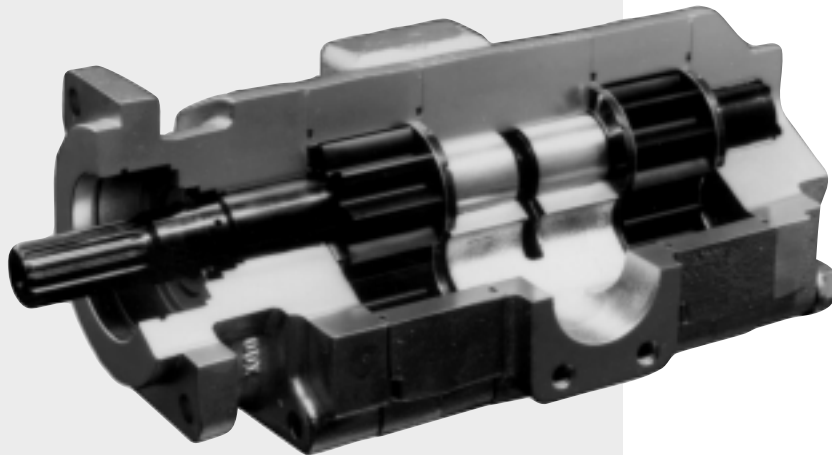

Single Pump

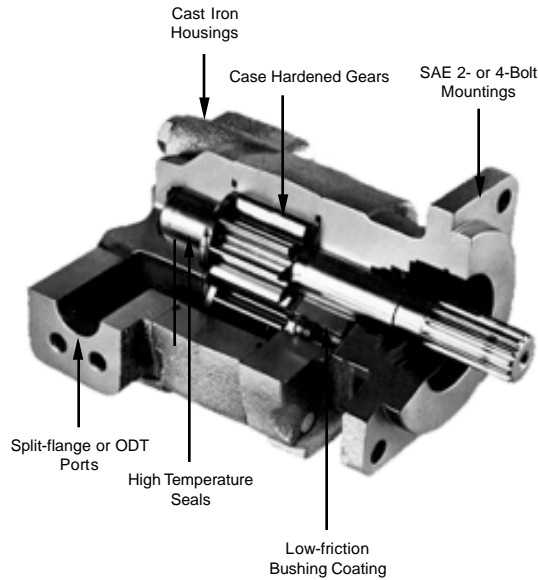

Multiple Pump

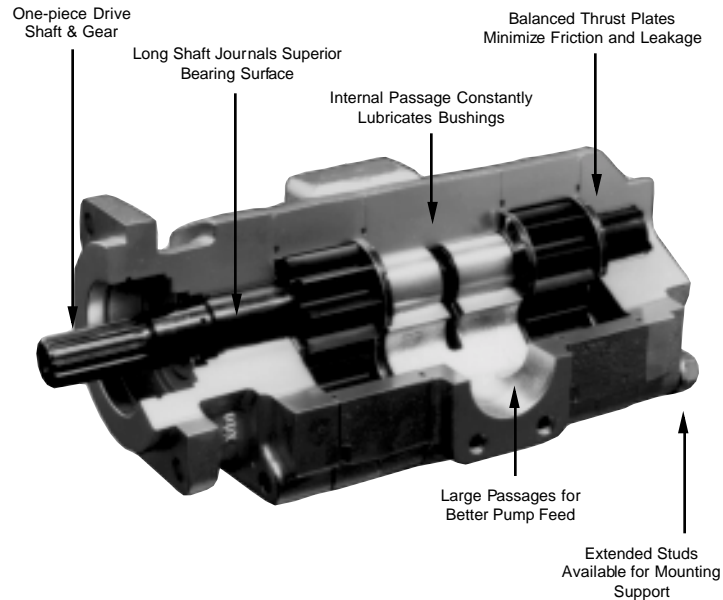

Use Genuine Parker Replacement parts

Legal Notification



FAILURE OR IMPROPER SELECTION OR IMPROPER USE OF THE PRODUCTS AND/OR SYSTEMS DESCRIBED HEREIN OR RELATED ITEMS CAN CAUSE DEATH, PERSONAL INJURY AND PROPERTY DAMAGE.

This document and other information from Parker Hannifin Corporation, its subsidiaries and authorized distributors provide product and/or system options for further investigation by users having technical expertise. It is important that you analyze all aspects of your application and review the information concerning the product or system in the current product catalog. Due to the variety of operating conditions and applications for these products or systems, the user, through its own analysis and testing, is solely responsible for making the final selection of the products and systems and assuring that all performance, safety and warning requirements of the application are met.

The products described herein, including without limitation, product features, specifications, designs, availability and pricing, are subject to change by Parker Hannifin Corporation and its subsidiaries at any time without notice.

Offer of Sale

The items described in this document are hereby offered for sale by Parker Hannifin Corporation, its subsidiaries or its authorized distributors. This offer and its acceptance are governed by the provisions stated in the "Offer of Sale".

© Copyright 2002, Parker Hannifin Corporation, All Rights Reserved.



315/330/350/365 Service Manual

General Instructions

These service instructions will familiarize you with Parker's single and multiple pumps

- their component parts
- the relative position of each part
- proper methods for assembly or disassembly of the units

To facilitate the repair of these units and before any work is done, we suggest that you first read all of the steps used in disassembly and assembly.

Dirt is the enemy of any hydraulic system. The first requirement for good maintenance of hydraulic equipment is cleanliness. **MAKE SURE YOU DISASSEMBLE AND ASSEMBLE YOUR HYDRAULIC EQUIPMENT IN A CLEAN AREA.**

The pictures show Model PGP365. Notes in the text cover variations between this unit and the other models.

It is important to airblast all parts and wipe them with a clean, lintless cloth before assembly.

USE CAUTION IN GRIPPING ALL PARTS IN THE VISE TO AVOID DAMAGING MACHINED SURFACES.

A pump must be driven in the direction of rotation for which it was built; otherwise, pressure will blow the shaft seal. Check the exploded view and notes at right for proper direction of rotation.

Parker's Replacement Parts

Parker's replacement parts are of original equipment standards. For assured quality of material and workmanship, and for compatibility in assembly, **USE ONLY GENUINE PARTS.**

Check all replacement parts before installing them to be certain that they were not damaged in shipment.

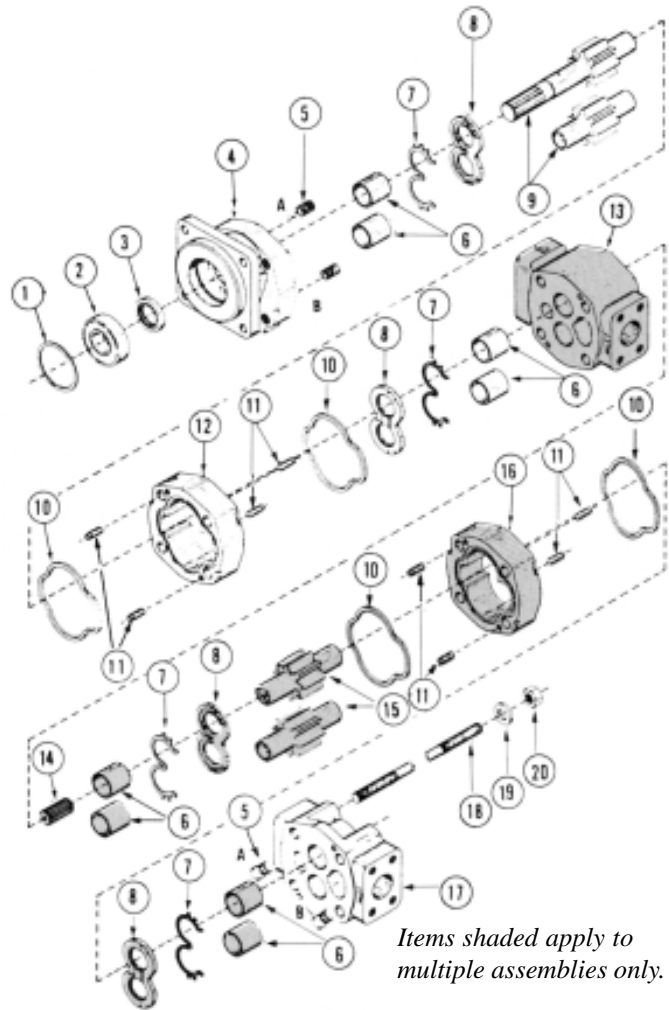

Items shaded apply to multiple assemblies only.

NOTE:

For PGP315 and PGP330 ONLY - Plug 5 required in position A and position B.

For PGP350 and PGP365 ONLY - Plug 5 in position B gives clockwise rotation. Plug 5 in position A gives counterclockwise rotation.

PARTS LIST

1. Snap Ring	11. Dowel Pins (Solid for PGP/PGM 315, 330 and 350. Hollow for PGP/PGM 365 ONLY.)
2. Outboard Bearing	12. Gear Housing
3. Seal	13. Bearing Carrier
4. Shaft End Cover	14. Connecting Shaft
5. Plug	15. Matched Gear Set
6. Bushings	16. Gear Housing
7. Channel Seal	17. Port End Cover
8. Thrust Plates	18. Studs or Cap Screws
9. Integral Drive Shaft and Gear Set	19. Washers
10. Gasket Seal	20. Nuts

Tool List

- Arbor press
 - Awl
 - 1 1/2" Dia. steel ball
 - Bearing puller (Owatonna Tool Co. M D - 956 or equivalent)
 - Bushing remover tool (See A)
 - Clean, lintless cloths
 - Deburring tool (an old file with cutting teeth ground off)
 - Machinist's hammer
 - Soft hammer
 - Permatex Aviation Form-A-Gasket™ No. 3 non-hardening sealant or equivalent
 - Medium grit carborundurn stone
 - Seal removal tool (See B)
 - Oil and grease
 - Snap ring pliers
 - Prick punch
 - Bushing installation tool (See C)
 - Scale (1/32" or 1/64" graduations)
 - Small screw driver
 - Torque wrench
 - Vise with 6" minimum opening.
 - Bar for lip seal installation
- Note: For PGP/PGM315 use 1 5/8" dia. x 2" bar.
 For PGP/PGM330 use 1 3/4" dia. x 2" bar.
 For PGP/PGM350 use 2 1/2" dia. x 2" bar.
 For PGP/PGM365 use 2 1/2" dia. x 2" bar.*
- Special steel sleeve (see sketch)

Bushing Puller: The bushings in PGP/PGM315, 330, 350 and 365 pumps may be removed from their bores, using blind hole collet-type bushing pullers similar to those manufactured by Owatonna Tool Co. The table below illustrates the modifications necessary to adapt the OTC collets to this task. Equivalent pullers from other suppliers may be modified in similar fashion.

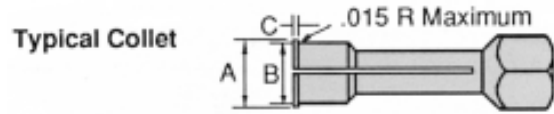

(A)

Pump/Motor	A	B	C	Make From OTC Collet No.
PGP/PGM 315	.900 .890	.800 .790	.100 .090	33863
PGP/PGM 330	.960 .970	.875 Ref.	.100 .090	33863
PGP/PGM 350	1.122 1.122	1.000 0.990	.072 .052	33864
	1.382 1.372	1.260 1.250	.100 .120	33865

Bushing Installation Tool
 A.I.S.I. 8620 Bearing Quality Steel
 Heat Treated



(B)

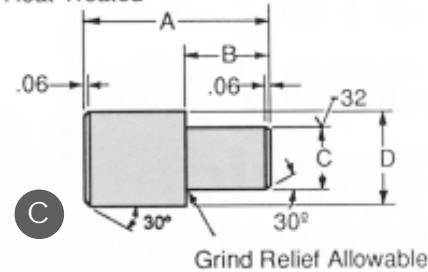

(C)

	A	B	C Dia.	D. Dia.
PGP/PGM 315	2.312	1.15	.937 +.000 -.002	1.250
PGP/PGM 330	3.00	1.47	1.054 +.000 -.002	1.250
PGP/PGM 350	3.00	1.47	1.282 +.000 -.002	1.625
PGP/PGM 365	3.00	1.73	1.492 +.000 -.002	1.750

Seal Removal Tool
 Easily made from an old screw driver. Heat the tip and bend as shown. Grind the tip to fit the notch behind the shaft seal.

Special Steel Sleeve

The special steel sleeve is used to insert the drive shaft through the lip seal without damage and can be made from bar stock: For the PGP/PGM315 use a 1 " dia. x 3-1/8" bar; for the PGP/PGM330 use a 1-1/8" or 1-1/4" dia. x 4- 5/8" bar; for the PGP/PGM350 use a 1-3/8" dia. x 4-5/8" bar; for the PGP/PGM365 use a 1- 1/2" dia. x 4-5/8" bar. The drawing and chart give details for making this special tool.

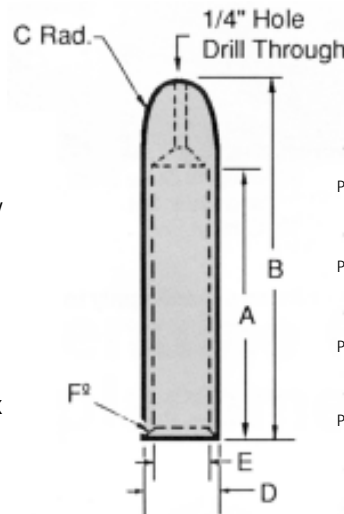

	A	B	C Rad	D Dia.	E. Dia.	F° chamfer
PGP/PGM 315	1-7/8"	3"	9/16"	.944 +.000 -.002	.885 +.002 -.000	.050° x 60°
PGP/PGM 330	3-3/8"	4-1/2"	9/16"	1.065 +.000 -.002	1.002 +.002 -.000	.015° x 45°
PGP/PGM 350	3-3/8"	4-1/2"	9/16"	1.290 +.000 -.002	1.250 +.002 -.000	.015° x 60°
PGP/PGM 365	3-3/8"	4-1/2"	9/16"	1.377 +.000 -.002	1.250 +.002 -.000	.015° x 60°

All external surfaces must be free of scratches and burrs.

Start Disassembly Here

CAUTION:

1. If prying off sections becomes necessary, take extreme care not to mar or damage machined surfaces. Excessive force while prying can result in misalignment and seriously damage parts.
2. If parts are difficult to fit during assembly, tap gently with a soft hammer (never use an iron hammer).
3. Gears are closely matched, therefore they must be kept together as sets when removed from a unit. Handle with care to avoid damage to the journals or teeth. Avoid touching gear journals.
4. Never hammer bushings into bores; use an arbor press.



1) Place the pump in a vise with the drive shaft pointing down. Caution: DO NOT GRIP ON OR NEAR ANY MACHINED SURFACES DURING ASSEMBLY OR DISASSEMBLY. Match-mark all sections. Be sure to align these marks when reassembling.

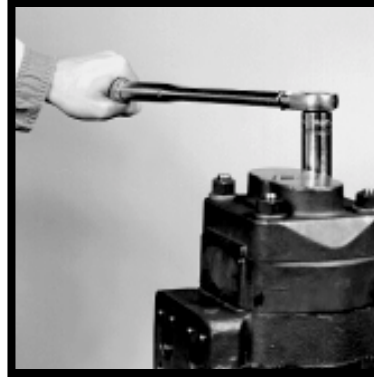

2) Use a socket wrench to remove the 4 cap screws on single units or the 4 hex nuts, studs and washers of multiple units.



3) Lift off the port end cover. If prying is necessary, be careful not to damage the machined surfaces. Dowel pins will remain in either the port end cover or the gear housing.



4) Remove the thrust plate. Examine and replace if necessary. See wear guide page 10.



5) Carefully remove the drive and driven gears. Avoid tapping the gear teeth together or against other hardened surfaces. Keep these gears together because they are a matched set. Examine and replace if necessary. (See page 10). Remove the thrust plate from the bearing carrier. Examine and replace if necessary.

For multiple assemblies only

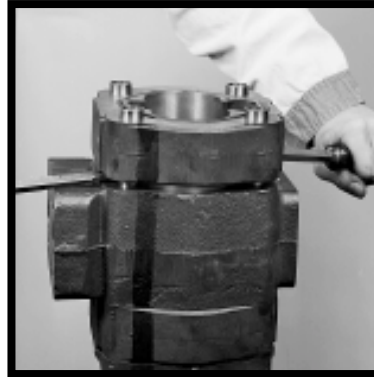

6) Lift the gear housing from the bearing carrier. If prying is necessary, take care not to damage machined surfaces. Examine and replace if necessary. (See page 10)

For multiple assemblies only



7) Carefully lift or pry off the bearing carrier to prevent damage to contact face and edges. Dowel pins will remain in either the bearing carrier or the gear housing. **DO NOT REMOVE THEM.**
For multiple assemblies only



8) Remove the connecting shaft. Remove the thrust plate. Examine and replace if necessary. (See page 10). Remove the driven gear and the integral gear and drive shaft. Keep these together as they are a matched set. Examine and replace if necessary. (*See page 10). Be careful not to damage the machined surfaces of the gears.



9) Lift or pry off the first section gear housing. Be careful not to damage machined surfaces. Examine and replace if necessary (see page 10).



10) Inspect all bushings for scoring or discoloration and replace if necessary. Use a bushing puller as shown in the tool list to remove bushings (see page 4).



11) If the pump is equipped with an outboard bearing, place the shaft end cover in the vise with the mounting face up. Remove the snap ring with snap ring pliers. If a unit is equipped with a spiral-lock retaining ring, remove with a small screwdriver or awl.



12) Use a bearing puller to remove the outboard bearing.



13) Grip the shaft end cover in a vise with the mounting face down. Remove double lip seal by inserting the special seal removal tool (see Tool List) into the notch between the double lip seal and the shaft end cover. Tap the seal out and discard. Remove and discard all rubber and polymer seals.

Start Assembly Here



1) Stone all machined surfaces with a medium grit carborundum stone.



2) If the bushings have been removed, deburr the bushing bores with an emery cloth. Rinse parts in a solvent. Air blast all the parts and wipe with a clean, lintless cloth before starting assembly.



3) Grip shaft end cover in vise with mounting face down. Examine plug or plugs* to be sure they're tightly in place. Replacement is necessary only if parts are damaged. Remove with screwdriver.
 *PGP/PGM315 and 330 have two plugs in both the shaft end and port end covers. PGP/PGM350 and 365 have one plug on the outlet side of their shaft end and port end covers.



4) New plugs should be screwed in tightly. Stake the plug with a prick punch at both ends of the screwdriver slot and around edges. Peen the edge of the hole 1/32" to 1/16" with a 1-1/2" diameter steel ball.
 NOTE: If new plug or plugs are being installed, coat threads with Loctite™ thread sealant.



5) Note: Assembly steps 5, 6, 7 & 8 apply to shaft end cover, bearing carrier and port end cover. Any bushings removed from the shaft end cover, port end cover or bearing carrier should be assembled in the drive bores with the groove to the top of unit (12 o'clock). Assemble the bushings in the driven bores with the groove to the bottom of the unit (6 o'clock). The PGP/PGM315 does not have grooved bushings, therefore the bushing seams should be placed at the 12 and 6 o'clock positions.



6) Bushings should be pressed into the bores, one at a time, using the special installation tool and an arbor press. Be sure that the grooves (or seams) are positioned as stated in Step #5. The bushings must be pressed into the bores flush with the casting face. Be sure to support the castings so that they are square and level.



7) Repeat Steps 1 and 2, stone and rinse parts.

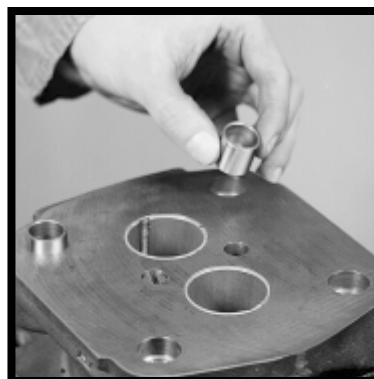

8) See that dowel pins are in place in any new castings. Examine all of the dowels. Before inserting, make certain that the hole is clean and free from burrs. Gently start the pin straight into the hole and tap lightly with a soft hammer.



9) Before inserting a new lip seal in the shaft end cover, coat the outer edge of the lip seal and its recess with Permatex Aviation Form-A-Gasket™ No. 3 non-hardening sealant or equivalent. With the metal side of the lip seal up, press it into the mounting flange side of the shaft end cover with an arbor press and bar (see Tool List on page 4). Be careful not to damage the lip of the seal. Press in until flush with the recess. Wipe off excess sealant.

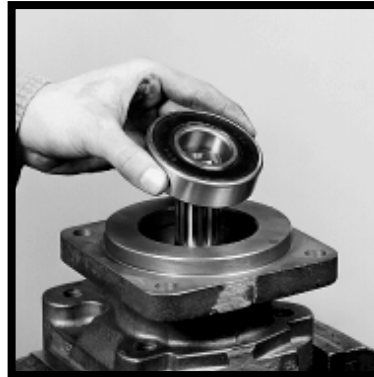

10) If the unit is equipped with an outboard bearing, guide the bearing into its recess in the shaft end cover. This is a light press fit. It may be necessary to lightly tap the bearing into the bore.

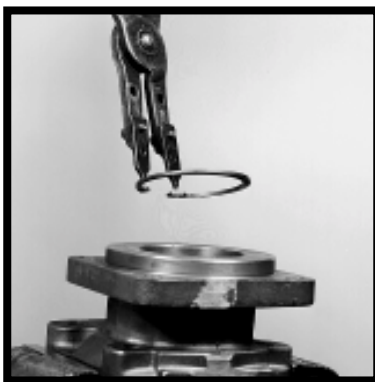

11) Install the snap ring in the groove to retain the outboard bearing.



12) Grease the new gasket seals and insert them into the grooves in both sides of all gear housings. Position the first gear housing over the shaft end cover and dowels. Tap it with a soft hammer until it rests tightly against the shaft end cover. Be careful not to pinch the gasket seal. Also be sure that the large rounded core is on the inlet side.



13) Assemble the channel seals into the grooves in the thrust plates with the flat side of the seal facing away from the thrust plate as shown below.

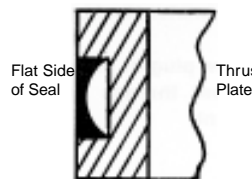

14) Gently slip the thrust plate through the gear housing and into place on the shaft end cover. The channel seal from Step #13 should face the shaft end cover. The relief groove in the plate should face the outlet side of the pump.



15) Slide the driven gear through the housing and into the bushing in the shaft end cover. Coat the steel sleeve tool with grease. Place the lightly-greased drive shaft inside the sleeve and slide both through the shaft end cover with a twisting motion, until the integral gear rests against the thrust plate. Avoid damaging the double lip seal. Remove the steel sleeve. Squirt clean oil over the gears.



16) Slip the thrust plate with the seal over the gear journals and into the housing bore. The flat side of the seal should face up with the relief groove facing the outlet side. (For single pump assemblies go directly to Step #21).



17) Place the bearing carrier onto the journals of the drive and driven gears. Be sure to line up the dowel holes over the dowel pins. When the parts are parallel, squeeze them together or alternately tap over each dowel until the parts are together.



18) Insert the connecting shaft into the spline of the drive gear. Position and place the second gear housing on the bearing carrier as outlined in Step #12.

For multiple assemblies only



19) Place the thrust plate in the gear housing per Step #14. Insert the drive and driven gears of the second section in their respective bearings. Make certain the gears are in contact with the thrust plate face. Place the port end cover plate in the housing per Step #16.

For multiple assemblies only



20) Check the plug or plugs in the port end cover to be sure that they are tight. Follow the procedure outlined in Step #4 for new plugs.

For multiple assemblies only



21) Place the port end cover over the gear journals. Align the dowels with the holes in the mating casting. Being careful not to pinch the gasket-seal, tap the port end cover lightly in the center between bearing bores to engage the dowels and to move parts together in the final seating.



22) Thread the fasteners into the shaft end cover and tighten alternately or cross corner. Rotate the drive shaft with a 6" wrench to check for binding. If there is no internal binding, torque diagonally opposed fasteners to 200 ft. lbs. (2400 in. lbs.); 141 ft. lbs. (1700 in. lbs.) for PGP/PGM315 models; 450 ft. lbs. (5400 in. lbs.) for PGP/PGM365.

Guideline for acceptable wear

Gear Housings

Wear in excess of .007" cut-out necessitates replacement of the gear housing. Place a straight-edge across bore. If you can slip a .007 feeler gage under the straight-edge in the cut-out area, replace the gear housing.



Pressure pushes the gears against the housing on the low pressure side. As the hubs and bushings wear, the cut-out becomes more pronounced. Excessive cut-out in a short period of time indicates excessive pressure or oil contamination. If the relief valve settings are within prescribed limits, check for shock pressures or tampering.

When the cut-out is moderate, .007" or less, the gear housing is in good condition and may be reused.

Gears

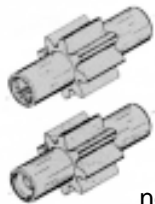

Any scoring on gear hubs necessitates replacement. Scoring, grooving, or burring of the outside diameter of the teeth requires replacement. Nicking, grooving, or fretting of teeth surfaces also necessitates replacement.

Drive Shafts

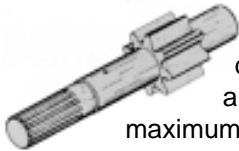

Replace if there is any wear detectable by touch in the seal area or at the drive coupling. The maximum allowable wear is .002".

Wear in the shaft seal area indicates oil contamination. Wear or damage to splines, keys, or keyways necessitates replacement.

Thrust Plates

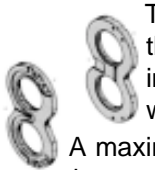

The thrust plates seal the gear section at the sides of the gears. Wear here will allow internal slippage, that is, oil will bypass within the pump.

A maximum of .002" wear is allowable. Replace thrust plates if they are scored, eroded or pitted. Check center of thrust plates where the gears mesh. Erosion here indicates oil contamination. Pitted thrust plates indicate cavitation or oil aeration. Discolored thrust plates indicate overheating, likely due to insufficient oil.

Dowel Pins

 If either the dowel or dowel hole is damaged, the dowel or machined casting, or both, must be replaced.

 If more than reasonable force is required to seat dowels, the cause may be poorly deburred or dirty parts; cocking of the dowel in the hole or improper pin-to-hole fit.

Bushings

 If gears are replaced, bushings must be replaced. Bushings should fit into the bore with a heavy press fit.

Seals and Gaskets

 Replace all rubber and polymer seals, including all "O" rings, thrust plate channel seals, shaft seal and gasket seals.

Plugs

 Examine the plugs in the shaft end and port end cover to make sure that they are in the proper position and tight. The PGP/PGM315 and PGP/PGM330 should have two plugs in both the shaft end and port end in tandem units only. The PGP/PGM350 and PGP/PGM365 have one plug in their shaft and port ends high pressure side only.

Lubrication and Oil Recommendations

All parts, with the exception of the outboard bearing, are lubricated by the hydraulic oil in the circuit. Particular attention must be paid to keep clean oil in the circuit system. Whenever there is a pump or motor failure, and there is reason to feel that metal particles may be in the system, the oil must be drained, the entire system flushed clean and any filter screens thoroughly cleaned or replaced. New oil should be supplied for the entire system. Oil suitable and recommended for use in circuits involving Parker's pumps and motors should meet the following specifications:

Viscosity:

- 50 SSU minimum @ operating temperature
7500 SSU maximum @ starting temperature
- 150 to 225 SSU @ 100° F. (37.8°C.) (generally)
44 to 48 SSU @ 210° F. (98.9° C.) (generally)

Approximate SSU @

Oil Grade	100° F. (37.8° C.)	210° F. (98.9° C.)
SAE 10	150	43
SAE 20	330	51

Viscosity Index: 90 minimum

Aniline Point: 175 minimum

Recommended Additives: Foam depressant, rust and oxidation inhibitors. Filtration: 10 micron recommended for maximum pump life.

Other Desirable Characteristics:

- Stability of physical and chemical characteristics.
- High demulsibility (low emulsibility) for separation of water, air and contaminants.
- Resistant to the formation of gums, sludges, acids, tars and varnishes.
- High lubricity and film strength.

General Recommendations:

A good-quality hydraulic oil conforming to the characteristics listed above is essential to the satisfactory performance and long life of any hydraulic system.

The oil should be changed on regular schedules in accordance with the manufacturer's recommendations, and the system periodically flushed.

The oil temperature in the reservoir must not exceed 200° F., (93.3° C.) with a maximum temperature of 180° F. (82.2° C.) recommended. Higher temperatures will result in rapid oil deterioration.

Reservoir capacity should equal in gallons the pump output in gpm or the total gpm of all pumps, where there is more than one in the system.

Oil poured into the reservoir should pass through a 100-mesh screen. Pour only clean oil from clean containers into the reservoir. A 100-mesh screen may be used in the suction line leading to the pump. A suction filter should be of sufficient size to handle twice the pump capacity. It must be cleaned and checked regularly to avoid damage due to contamination and cavitation.

Normal Temperatures:

0° F. (-1 8° C.) to 100° F. (37.8° C.) Ambient 100° F. (37.8° C.) to 180° F. (82.2° C.) System. Be sure your oil is recommended for the temperatures you expect to encounter.

Cold Weather Operation:

Oils for use in cold weather should have a viscosity not exceeding 7500 SSU at the minimum start-up temperature. A pour point of at least 20° F. below start-up temperature is recommended. Start-up procedures should allow for a gradual warm-up until the oil reaches a reasonably fluid state.

Continued on the following page.

Continued from the previous page

The Use of Other Fluids:

- Automatic Transmission Fluid (ATF): In general, ATF performance is satisfactory; however these fluids are sometimes too expensive for normal use in hydraulic systems.
- Diesel Fuel or Kerosene (Coal Oil): Though sometimes used as dilutants for cold weather operations, they are not recommended, as they are not sufficiently refined.
- Fire Resistant Fluids: **DO NOT USE ANY FIRE RESISTANT FLUIDS OR NON-PETROLEUM OILS WITHOUT CONSULTING OUR TECHNICAL SERVICE DEPARTMENT.**
- These suggestions are intended as a guide only. **OBTAIN YOUR FINAL FLUID RECOMMENDATIONS FROM YOUR FLUID SUPPLIER.**

Recommended Start-up Procedure For New or Rebuilt Pump

Before installing a new or rebuilt pump, back off the main relief valve until the spring tension on the adjusting screw is relieved. This will avoid the possibility of immediate damage to the replacement unit in the event that the relief valve setting had been increased beyond the recommended operating pressure, prior to removing the old unit.

Before connecting any lines to the pump, fill all ports with clean oil to provide initial lubrication. This is particularly important if the unit is located above the oil reservoir.

After connecting the lines and mounting the replacement unit, operate the pump at least two minutes at no load and at low rpm (400 min.) During this break-in period, the unit should run free and not develop an excessive amount of heat. If the unit operates properly, speed and pressure can then be increased to normal operating settings.

Reset the main relief valve to its proper setting while the pump is running at maximum operating engine (motor) speed for the vehicle.

ALWAYS USE AN ACCURATE GAUGE
WHEN ADJUSTING THE RELIEF VALVE
PRESSURE SETTING.

Recommended Test Procedure

Make certain that there is an adequate supply of oil for the pump; at least one gallon of oil for each gpm of pump capacity.

If one section of a tandem pump is being tested, make sure that all other sections not being tested are adequately supplied with oil. If any of the other sections run dry, or if plugs are left in ports, serious and permanent damage will result.

The oil should be a good quality hydraulic oil rated at 150 SSU at 100° F., with the oil temperature held at 120° F. plus or minus 50° F. (Test procedures are described in detail in SAE handbooks; see Hydraulic Power Pump Test Procedure, SAE J745c.)

The feed line must be of adequate size with no more than 5" mercury vacuum adjacent to the pump inlet. As a rule, the feed line must provide a feed flow velocity not in excess of 8 feet per second.

Feeding hot oil into a cold pump may cause the pump to seize. Jog the pump by momentarily starting and stopping repeatedly the driving engine or motor to gradually equalize pump and oil temperatures.

Run the pump at least two minutes at no load and moderate speed (not over 1500 rpm). If the pump becomes excessively hot, shut down immediately and locate the problem source.

Gradually increase pressure on pump, in 500 psi increments until the desired test pressure has been reached. This should take about five minutes.

Delivery should run close to rated catalog performance figures, which are averaged from testing several pumps. A 5% lower reading may be used as a rated minimum if new or relatively new parts have been used. When rebuilding the pump with parts from the original pump, which, while worn, appear satisfactory for reuse, a 10% or 15% lower reading may be permitted, depending on the performance expected from the equipment. One's own experience will prove the best guide here.

Many repairmen measure the output at normal operating speed and at zero pressure, then again at 1000 psi (or the operating pressure of the equipment) and allow a volume decrease approximating the listing below. It is a suggested reference only which makes allowance for reused parts.

At test speeds other than 1800 rpm, gpm delivery will vary almost proportionately, but the same (drop-off) figures should be used.

Be sure to run the pump in the direction for which it was designed and built. Driving the pump in the wrong direction will build up pressure behind the shaft seal, damaging it and necessitating replacement.

After completing testing procedures, the pump is ready for installation and immediate duty operation on equipment. Again, it must be remembered that to prevent seizure, hot oil must not be fed into a cold pump.

GPM DELIVERY at 1800 rpm	GPM DROP OFF AT...		
	1000 psi/70 bar	2000 psi/140 bar	3000 psi/210 bar
10-30	1½-3	2-3½	2½-4
30-50	2-3	2½-4	3-4½
50-70	2½-3½	3-5	3½-5½

Offer of Sale

The items described in this document and other documents or descriptions provided by Parker Hannifin Corporation, its subsidiaries and its authorized distributors are hereby offered for sale at prices to be established by Parker Hannifin Corporation, its subsidiaries and its authorized distributors. This offer and its acceptance by any customer ("Buyer") shall be governed by all of the following Terms and Conditions. Buyer's order for any such items, when communicated to Parker Hannifin Corporation, its subsidiary or an authorized distributor ("Seller") verbally or in writing, shall constitute acceptance of this offer.

1. Terms and Conditions of Sale: All descriptions, quotations, proposals, offers, acknowledgments, acceptances and sales of Seller's products are subject to and shall be governed exclusively by the terms and conditions stated herein. Buyer's acceptance of any offer to sell is limited to these terms and conditions. Any terms or conditions in addition to, or inconsistent with those stated herein, proposed by Buyer in any acceptance of an offer by Seller, are hereby objected to. No such additional, different or inconsistent terms and conditions shall become part of the contract between Buyer and Seller unless expressly accepted in writing by Seller. Seller's acceptance of any offer to purchase by Buyer is expressly conditional upon Buyer's assent to all the terms and conditions stated herein, including any terms in addition to, or inconsistent with those contained in Buyer's offer. Acceptance of Seller's products shall in all events constitute such assent.

2. Payment: Payment shall be made by Buyer net 30 days from the date of delivery of the items purchased hereunder. Amounts not timely paid shall bear interest at the maximum rate permitted by law for each month or portion thereof that the Buyer is late in making payment. Any claims by Buyer for omissions or shortages in a shipment shall be waived unless Seller receives notice thereof within 30 days after Buyer's receipt of the shipment.

3. Delivery: Unless otherwise provided on the face hereof, delivery shall be made F.O.B. Seller's plant. Regardless of the method of delivery, however, risk of loss shall pass to Buyer upon Seller's delivery to a carrier. Any delivery dates shown are approximate only and Seller shall have no liability for any delays in delivery.

4. Warranty: Seller warrants that the items sold hereunder shall be free from defects in material or workmanship for a period of 18 months from date of shipment from Parker Hannifin Corporation. **THIS WARRANTY COMPRISES THE SOLE AND ENTIRE WARRANTY PERTAINING TO ITEMS PROVIDED HEREUNDER. SELLER MAKES NO OTHER WARRANTY, GUARANTEE, OR REPRESENTATION OF ANY KIND WHATSOEVER. ALL OTHER WARRANTIES, INCLUDING BUT NOT LIMITED TO, MERCHANTABILITY AND FITNESS FOR PURPOSE, WHETHER EXPRESS, IMPLIED, OR ARISING BY OPERATION OF LAW, TRADE USAGE, OR COURSE OF DEALING ARE HEREBY DISCLAIMED. NOTWITHSTANDING THE FOREGOING, THERE ARE NO WARRANTIES WHATSOEVER ON ITEMS BUILT OR ACQUIRED WHOLLY OR PARTIALLY, TO BUYER'S DESIGNS OR SPECIFICATIONS.**

5. Limitation Of Remedy: SELLER'S LIABILITY ARISING FROM OR IN ANY WAY CONNECTED WITH THE ITEMS SOLD OR THIS CONTRACT SHALL BE LIMITED EXCLUSIVELY TO REPAIR OR REPLACEMENT OF THE ITEMS SOLD OR REFUND OF THE PURCHASE PRICE PAID BY BUYER, AT SELLER'S SOLE OPTION. IN NO EVENT SHALL SELLER BE LIABLE FOR ANY INCIDENTAL, CONSEQUENTIAL OR SPECIAL DAMAGES OF ANY KIND OR NATURE WHATSOEVER, INCLUDING BUT NOT LIMITED TO LOST PROFITS ARISING FROM OR IN ANY WAY CONNECTED WITH THIS AGREEMENT OR ITEMS SOLD HEREUNDER, WHETHER ALLEGED TO ARISE FROM BREACH OF CONTRACT, EXPRESS OR IMPLIED WARRANTY, OR IN TORT, INCLUDING WITHOUT LIMITATION, NEGLIGENCE, FAILURE TO WARN OR STRICT LIABILITY.

6. Changes, Reschedules and Cancellations: Buyer may request to modify the designs or specifications for the items sold hereunder as well as the quantities and delivery dates thereof, or may request to cancel all or part of this order, however, no such requested modification or cancellation shall become part of the contract between Buyer and Seller unless accepted by Seller in a written amendment to this Agreement. Acceptance of any such requested modification or cancellation shall be at Seller's discretion, and shall be upon such terms and conditions as Seller may require.

7. Special Tooling: A tooling charge may be imposed for any special tooling, including without limitation, dies, fixtures, molds and patterns, acquired to manufacture items sold pursuant to this contract. Such special tooling shall be and remain Seller's property notwithstanding payment of any charges by Buyer. In no event will Buyer acquire any interest in apparatus belonging to Seller which is utilized in the manufacture of the

items sold hereunder, even if such apparatus has been specially converted or adapted for such manufacture and notwithstanding any charges paid by Buyer. Unless otherwise agreed, Seller shall have the right to alter, discard or otherwise dispose of any special tooling or other property in its sole discretion at any time.

8. Buyer's Property: Any designs, tools, patterns, materials, drawings, confidential information or equipment furnished by Buyer or any other items which become Buyer's property, may be considered obsolete and may be destroyed by Seller after two (2) consecutive years have elapsed without Buyer placing an order for the items which are manufactured using such property. Seller shall not be responsible for any loss or damage to such property while it is in Seller's possession or control.

9. Taxes: Unless otherwise indicated on the face hereof, all prices and charges are exclusive of excise, sales, use, property, occupational or like taxes which may be imposed by any taxing authority upon the manufacture, sale or delivery of the items sold hereunder. If any such taxes must be paid by Seller or if Seller is liable for the collection of such tax, the amount thereof shall be in addition to the amounts for the items sold. Buyer agrees to pay all such taxes or to reimburse Seller therefore upon receipt of its invoice. If Buyer claims exemption from any sales, use or other tax imposed by any taxing authority, Buyer shall save Seller harmless from and against any such tax, together with any interest or penalties thereon which may be assessed if the items are held to be taxable.

10. Indemnity For Infringement of Intellectual Property Rights: Seller shall have no liability for infringement of any patents, trademarks, copyrights, trade dress, trade secrets or similar rights except as provided in this Part 10. Seller will defend and indemnify Buyer against allegations of infringement of U.S. Patents, U.S. Trademarks, copyrights, trade dress and trade secrets (hereinafter 'Intellectual Property Rights'). Seller will defend at its expense and will pay the cost of any settlement or damages awarded in an action brought against Buyer based on an allegation that an item sold pursuant to this contract infringes the Intellectual Property Rights of a third party. Seller's obligation to defend and indemnify Buyer is contingent on Buyer notifying Seller within ten (10) days after Buyer becomes aware of such allegations of infringement, and Seller having sole control over the defense of any allegations or actions including all negotiations for settlement or compromise. If an item sold hereunder is subject to a claim that it infringes the Intellectual Property Rights of a third party, Seller may, at its sole expense and option, procure for Buyer the right to continue using said item, replace or modify said item so as to make it noninfringing, or offer to accept return of said item and return the purchase price less a reasonable allowance for depreciation. Notwithstanding the foregoing, Seller shall have no liability for claims of infringement based on information provided by Buyer, or directed to items delivered hereunder for which the designs are specified in whole or part by Buyer, or infringements resulting from the modification, combination or use in a system of any item sold hereunder. The foregoing provisions of this Part 10 shall constitute Seller's sole and exclusive liability and Buyer's sole and exclusive remedy for infringement of Intellectual Property Rights.

If a claim is based on information provided by Buyer or if the design for an item delivered hereunder is specified in whole or in part by Buyer, Buyer shall defend and indemnify Seller for all costs, expenses or judgments resulting from any claim that such item infringes any patent, trademark, copyright, trade dress, trade secret or any similar right.

11. Force Majeure: Seller does not assume the risk of and shall not be liable for delay or failure to perform any of Seller's obligations by reason of circumstances beyond the reasonable control of Seller (hereinafter 'Events of Force Majeure'). Events of Force Majeure shall include without limitation, accidents, acts of God, strikes or labor disputes, acts, laws, rules or regulations of any government or government agency, fires, floods, delays or failures in delivery of carriers or suppliers, shortages of materials and any other cause beyond Seller's control.

12. Entire Agreement/Governing Law: The terms and conditions set forth herein, together with any amendments, modifications and any different terms or conditions expressly accepted by Seller in writing, shall constitute the entire Agreement concerning the items sold, and there are no oral or other representations or agreements which pertain thereto. This Agreement shall be governed in all respects by the law of the State of Ohio. No actions arising out of the sale of the items sold hereunder or this Agreement may be brought by either party more than two (2) years after the cause of action accrues.

9/91-P



About Parker Hannifin Corporation

Parker Hannifin is a leading global motion-control company dedicated to delivering premier customer service. A Fortune 500 corporation listed on the New York Stock Exchange (PH), our components and systems comprise over 1,400 product lines that control motion in some 1,000 industrial and aerospace markets. Parker is the only manufacturer to offer its customers a choice of hydraulic, pneumatic, and electromechanical motion-control solutions. Our Company has the largest distribution network in its field, with over 7,500 distributors serving more than 350,000 customers worldwide.

Parker's Charter

To be a leading worldwide manufacturer of components and systems for the builders and users of durable goods. More specifically, we will design, market and manufacture products controlling motion, flow and pressure. We will achieve profitable growth through premier customer service.

Product Information

North American customers seeking product information, the location of a nearby distributor, or repair services will receive prompt attention by calling the Parker Product Information Center at our toll-free number: 1-800-C-PARKER (1-800-272-7537). In the UK, a similar service is available by calling 0500-103-203.

The Aerospace Group is a leader in the development, design, manufacture and servicing of control systems and components for aerospace and related high-technology markets, while achieving growth through premier customer service.



The Climate & Industrial Controls Group designs, manufactures and markets system-control and fluid-handling components and systems to refrigeration, air-conditioning and industrial customers worldwide.



The Fluid Connectors Group designs, manufactures and markets rigid and flexible connectors, and associated products used in pneumatic and fluid systems.



The Seal Group designs, manufactures and distributes industrial and commercial sealing devices and related products by providing superior quality and total customer satisfaction.



The Hydraulics Group designs, produces and markets a full spectrum of hydraulic components and systems to builders and users of industrial and mobile machinery and equipment.



The Filtration Group designs, manufactures and markets quality filtration and clarification products, providing customers with the best value, quality, technical support, and global availability.



The Automation Group is a leading supplier of pneumatic and electro-mechanical components and systems to automation customers worldwide.



The Instrumentation Group is a global leader in the design, manufacture and distribution of high-quality critical flow process instrumentation, ultra-high-purity, medical and analytical applications.





Parker Hannifin Corporation
Gear Pump Division
1775 Logan Avenue
Youngstown, OH 44501 USA
Tel: (330) 746-8011
Fax: (330) 746-1148
www.parker.com

Service Manual HY09-SM300/US
04/02T&M 2.5M