



Service Manual HY09-SM500/US

 [www.khadamathydraulic.com](http://www.khadamathydraulic.com)  
Tell: 021-55882749  
Tell: 021-33488178  
Fax: 021-33488105

## Service Manual PGP/PGM500

Effective: July 3, 2013  
Supersedes: All Others

---

### PGP/PGM500 Series

---

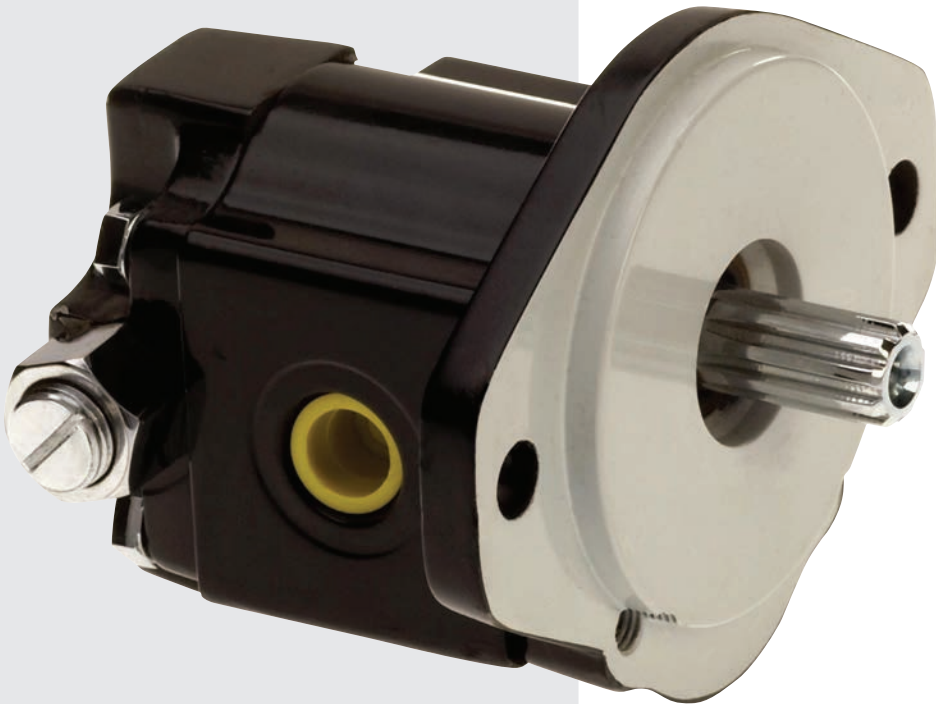

---

Legal Notification



FAILURE OR IMPROPER SELECTION OR IMPROPER USE OF THE PRODUCTS AND/OR SYSTEMS DESCRIBED HEREIN OR RELATED ITEMS CAN CAUSE DEATH, PERSONAL INJURY AND PROPERTY DAMAGE.

This document and other information from Parker Hannifin Corporation, its subsidiaries and authorized distributors provide product and/or system options for further investigation by users having technical expertise. It is important that you analyze all aspects of your application and review the information concerning the product or system in the current product catalog. Due to the variety of operating conditions and applications for these products or systems, the user, through its own analysis and testing, is solely responsible for making the final selection of the products and systems and assuring that all performance, safety and warning requirements of the application are met.

The products described herein, including without limitation, product features, specifications, designs, availability and pricing, are subject to change by Parker Hannifin Corporation and its subsidiaries at any time without notice.

**Offer of Sale**

The items described in this document are hereby offered for sale by Parker Hannifin Corporation, its subsidiaries or its authorized distributors. This offer and its acceptance are governed by the provisions stated in the "Offer of Sale".

© Copyright 2012, Parker Hannifin Corporation, All Rights Reserved.

# 505/511 Service Manual

## Single Pump

### General Instructions

These service instructions will familiarize you with Parker's single and multiple pumps:

- their component parts
- the relative position of each part
- proper methods for assembly or disassembly of the units

To facilitate the repair of these units and before any work is done, we suggest that you first read all of the steps used in disassembly and assembly.

Dirt is the enemy of any hydraulic system. The first requirement for good maintenance of hydraulic equipment is cleanliness. **MAKE SURE YOU DISASSEMBLE AND ASSEMBLE YOUR HYDRAULIC EQUIPMENT IN A CLEAN AREA.**

The pictures show a Model PGP511. Notes in the text cover variations between this unit and the other models.

It is important to airblast all parts and wipe them with a clean, lintless cloth before assembly.

**USE CAUTION IN GRIPPING ALL PARTS IN THE VISE TO AVOID DAMAGING MACHINED SURFACES.**

A pump must be driven in the direction of rotation for which it was built; otherwise, pressure will blow the shaft seal. Check the exploded view and notes at right for proper direction of rotation.

### Parker's Replacement Parts

Parker's replacement parts are of original equipment standards. For assured quality of material and workmanship, and for compatibility in assembly, **USE ONLY GENUINE PARTS.**

Check all replacement parts before installing them to be certain that they were not damaged in shipment.

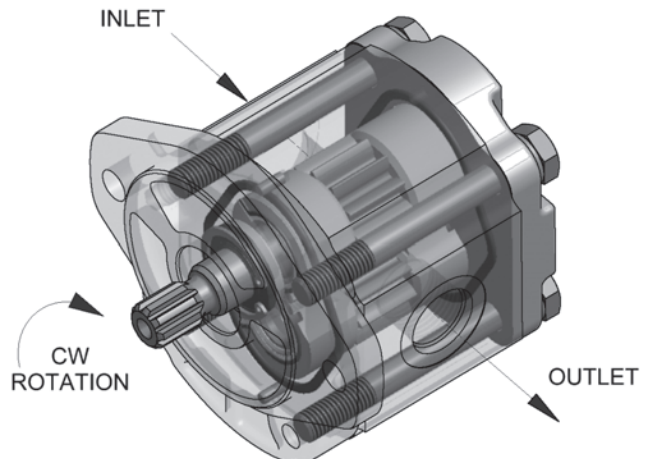
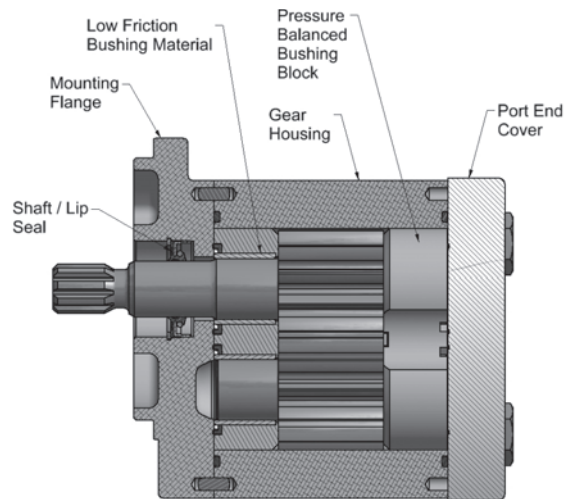
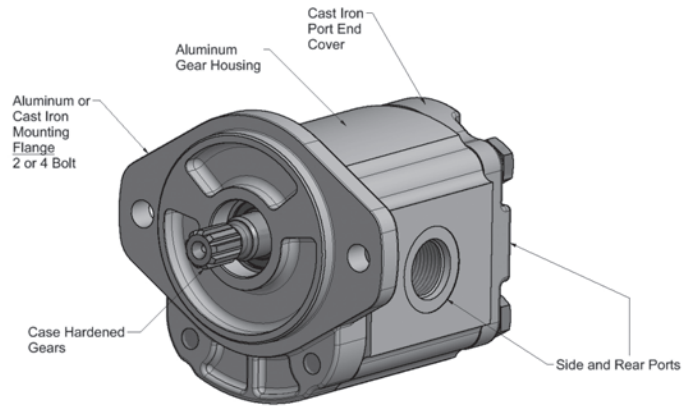

**PGP/PGM500 Exploded View**

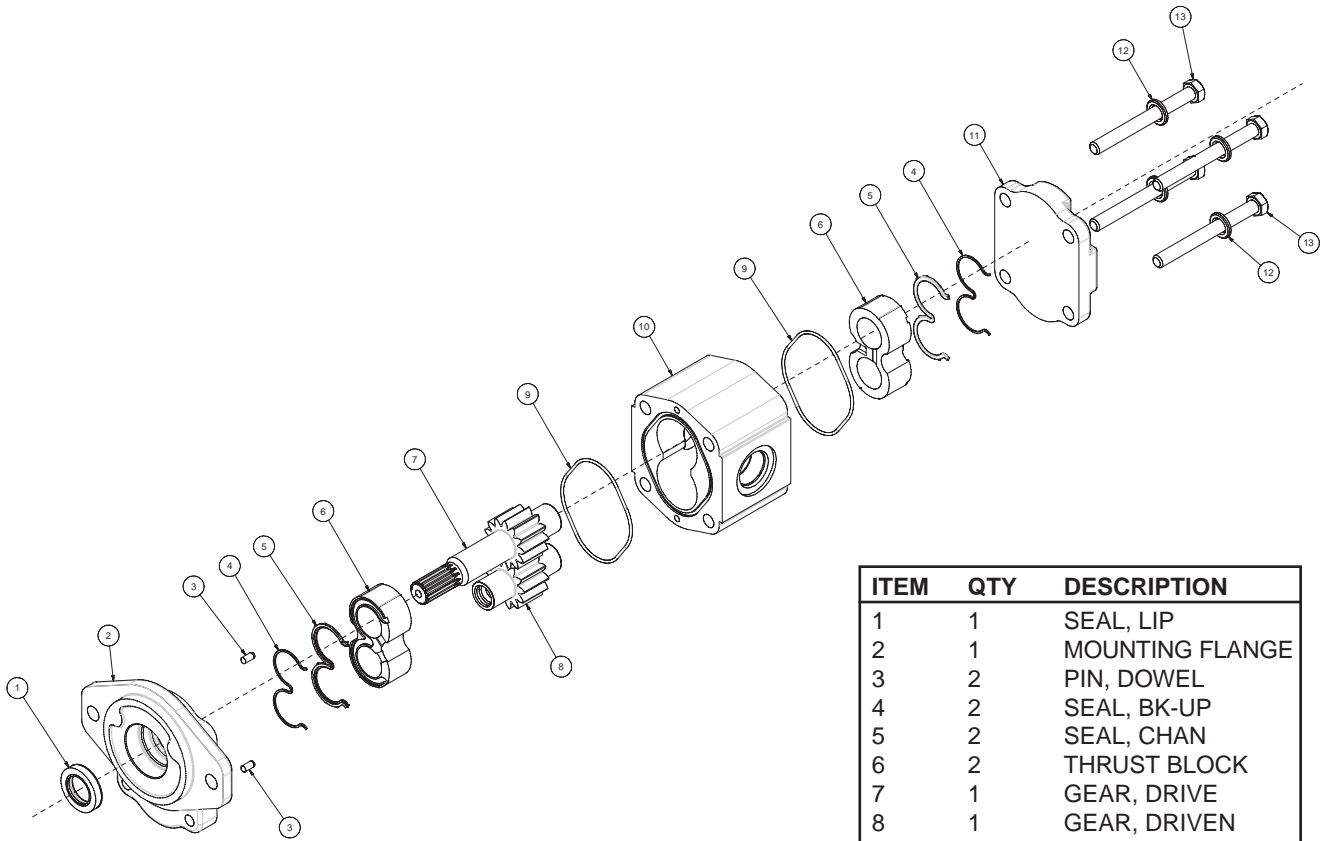

ITEM	QTY	DESCRIPTION
1	1	SEAL, LIP
2	1	MOUNTING FLANGE
3	2	PIN, DOWEL
4	2	SEAL, BK-UP
5	2	SEAL, CHAN
6	2	THRUST BLOCK
7	1	GEAR, DRIVE
8	1	GEAR, DRIVEN
9	2	SEAL, O-R
10	1	GEAR HOUSING
11	1	PORT END COVER
12	4	WASHER
13	4	CAPSCREW

**Tool List**

**Tool List**

- Arbor press
- Awl
- Clean, lintless cloths
- Deburring tool (an old file with cutting teeth ground off)
- Machinist's hammer
- Soft hammer
- Medium grit Carborundurn stone
- Seal removal tool (See B)
- Oil and grease
- Snap ring pliers
- Prick punch
- Scale ( 1/32" or 1/64" graduations)
- Small screw driver
- Torque wrench
- Vise with 6" minimum opening.
- Bar for lip seal installation
- Special mylar sleeve (see sketch)



**Seal Removal Tool**  
Easily made from an old screw driver. Heat the tip and bend as shown. Grind the tip to fit the notch behind the shaft seal.

**Special Mylar Sleeve**

The special mylar sleeve is used to insert the drive shaft through the lip seal without damage. The drawing and chart give details for making this special tool.

**NOTE:** Please see tool list for lip seal bar installation.

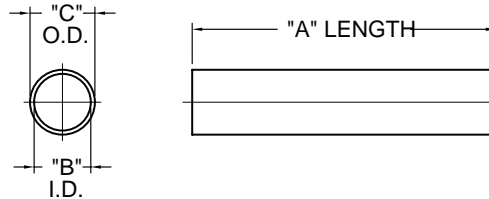

	A	B	C
PGP/PGM 505	2.71 - 3.190	0.631 - 0.634	0.634 - 0.635
PGP/PGM 511	2.940 - 3.000	0.690 - 0.694	0.698 - 0.702

## Seal Installation Tools

Constructed from mild steel

	SEC	DESCRIPTION	A	B	C	D	E	F	G	H
PGP/PGM 505	A1, A2	Integral Shaft	0.946	3.500	0.630	0.275	0.748	0.040	30°	0.060
PGP/PGM 505	L5	Continental Shaft	1.024	3.500	0.630	0.275	0.748	0.040	30°	0.060

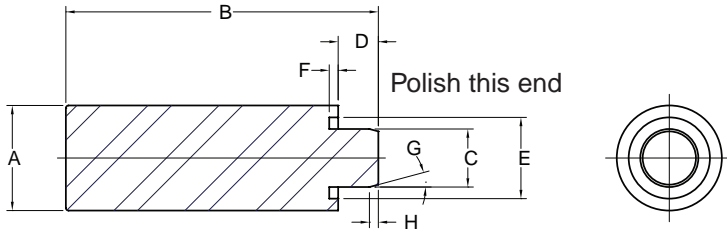

	SEC	DESCRIPTION	A	B	C	D	E	F
PGP/PGM 511	H2	Integral Shaft	0.786	1.368	0.295	0.974	0.500	3.250
PGP/PGM 511	H3	Integral Shaft	0.786	1.368	0.295	0.516	0.500	4.000

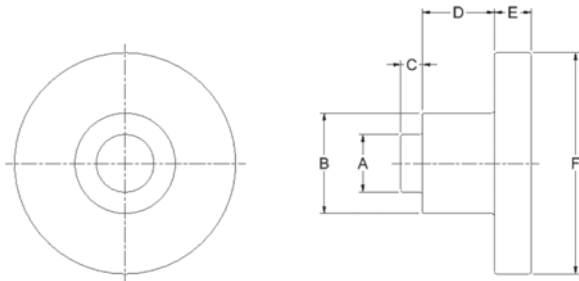

	SEC	DESCRIPTION	A	B	C	D	E	F	G
PGP/PGM 511	L2	Continental Shaft	1.8	1.400	1.750	2.000	3.200	8.250	0.750
PGP/PGM 511	L3	Continental Shaft	1.8	1.400	2.500	2.750	3.200	8.250	0.750

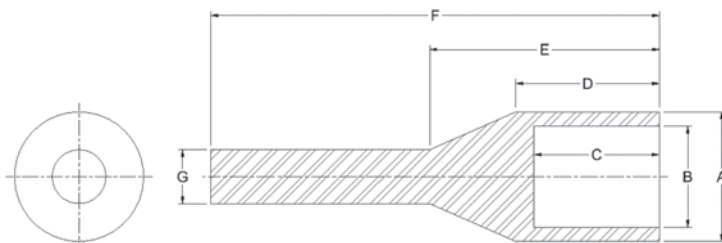

## Start Disassembly Here

**CAUTION:**

1. If prying off sections becomes necessary, take extreme care not to mar or damage machined surfaces. Excessive force while prying can result in misalignment and seriously damage parts.
2. If parts are difficult to fit during assembly, tap gently with a soft hammer (never use an iron hammer).
3. Handle with care to avoid damage to the journals or teeth. Avoid touching gear journals.

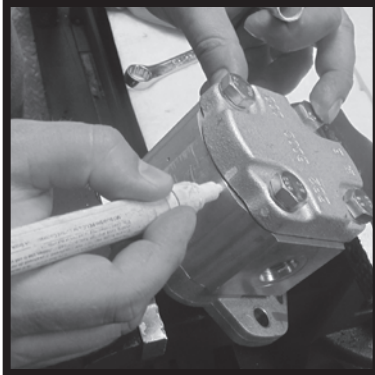

1) Place the unit in a vise with the drive shaft pointing down. Caution: DO NOT GRIP ON OR NEAR ANY MACHINED SURFACES DURING ASSEMBLY OR DISASSEMBLY. Match-mark all sections. Be sure to align these marks when reassembling.

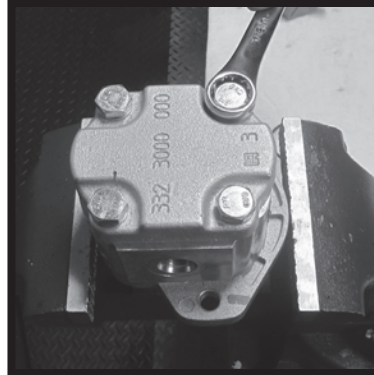

2) Use a metric wrench to remove the 4 cap screws.



3) Lift off the port end cover. If prying is necessary, be careful not to damage the machined surfaces.

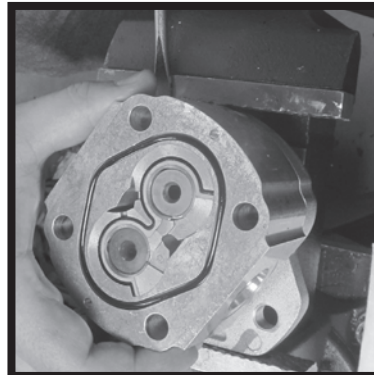

4) Remove gear housing. If prying is necessary, be careful not to damage the machined surfaces.

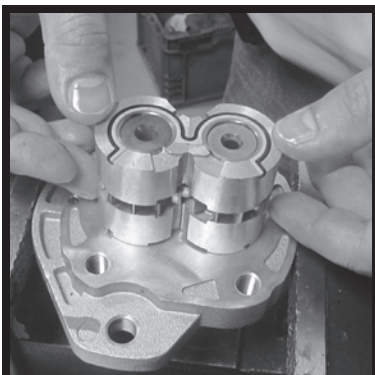

5) Mark bushing blocks top and bottom. Remove the bushing block. Examine and replace if necessary. See wear guide page 12.

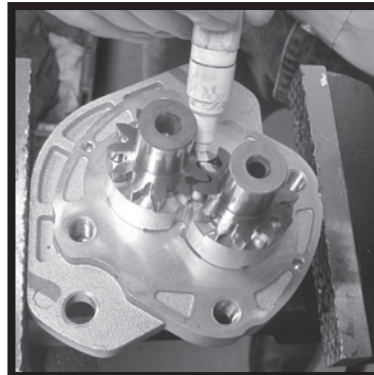

6) Match mark gears.



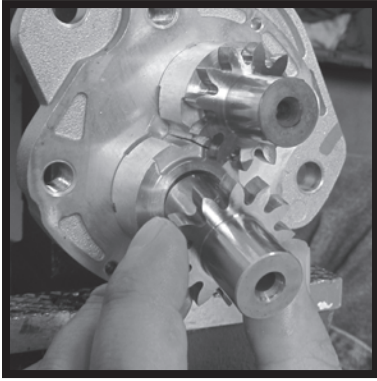

**7)** Carefully remove the drive and driven gears. Avoid tapping the gear teeth together or against other hardened surfaces. Examine and replace if necessary. (See page 12).



**8)** Carefully remove the bushing blocks from the bottom of body. Examine and replace if necessary. (See page 12)

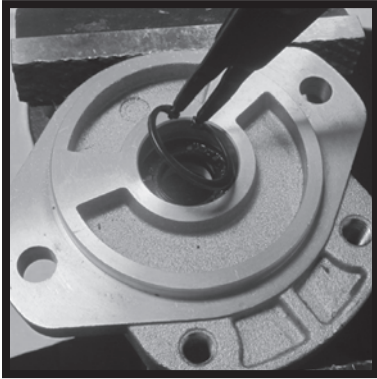

**9)** Remove the snap ring (located in front of the shaft seal).

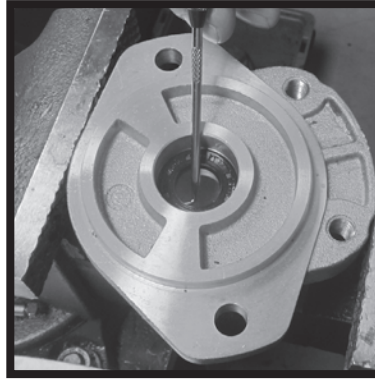

**10)** Pry out the shaft seal. Be careful not to damage seal bore in flange.

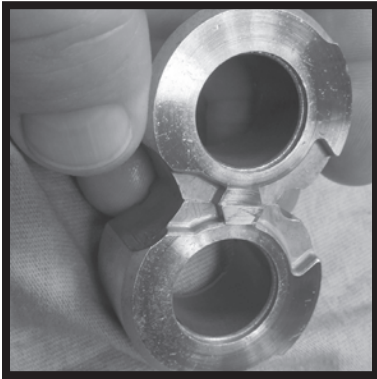

**11)** Inspect all bushings for scoring or discoloration and replace if necessary.



## Start Assembly Here

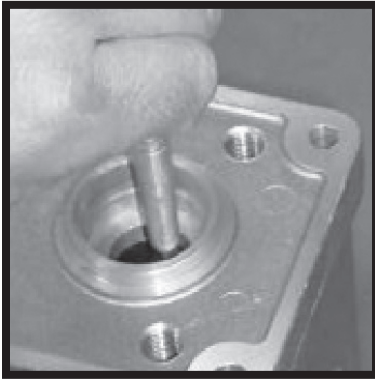

1) Clean seal bore thoroughly. When installing metal OD seals apply adhesive to the seal OD and the bore ID. Rubber OD seals do not require adhesive, instead a lubricant should be used on the OD.



2) Place a new shaft seal on the installation tool with the spring side facing outward.

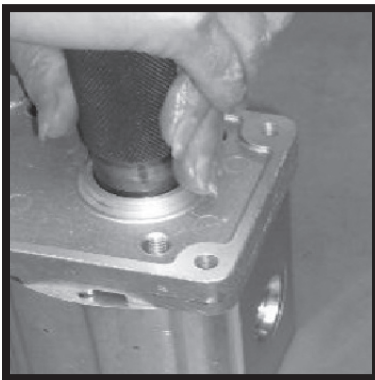

3) Press seal to a depth that is just deep enough to allow installation of the snap ring.

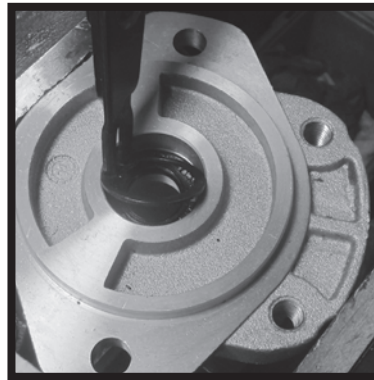

4) Assemble the snap ring. A new snap ring should be used if supplied in the seal kit.

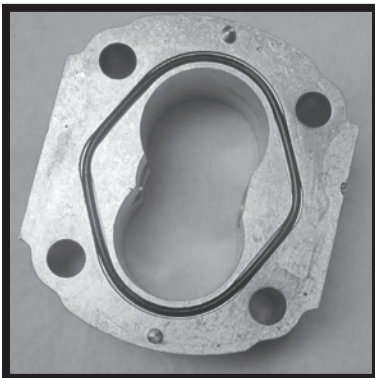

5) Check the section seal. Use of a new one is recommended in each case. Grease the new section seal to hold it in the groove.

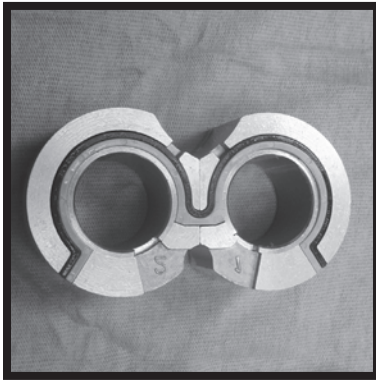

**6)** Assemble new sealing parts, the rubber seal first, the plastic seal on top. (Pump thrust block shown with seals installed.)

**NOTE:** The seals face the high pressure side of the pump.

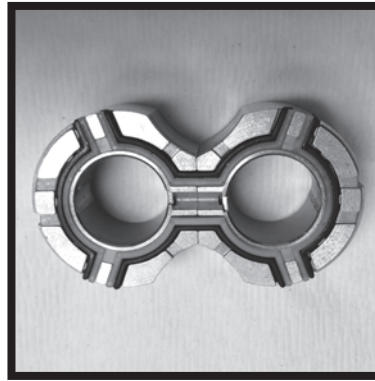

**7)** Motor thrust block with seals installed.

The instructions for proper installation for a 2 piece pump seal are as follows:

1. Turn the thrust blocks so the seal groove faces up
2. Place the soft black Buna-N seal into the seal groove with the flat side down
3. Place the hard nylon back-up seal, flat side up, into the groove on top of the Buna-N seal

### 511 Pump Thrust Blocks

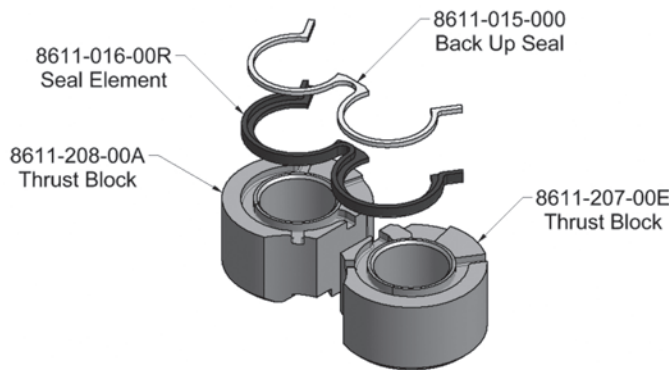

### 511 Motor Thrust Blocks

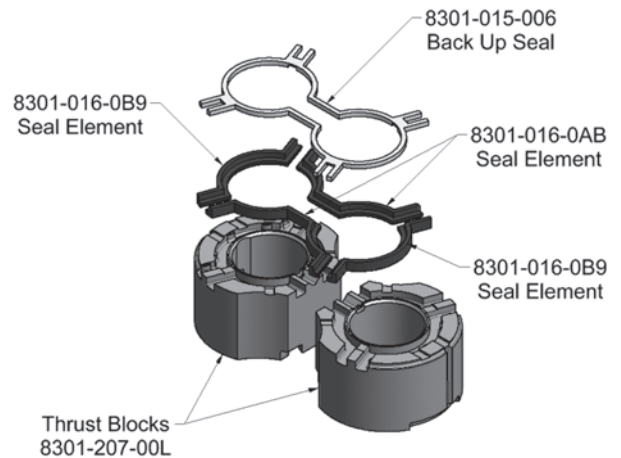

The proper seal installation is very important. If these seals are assembled upside down they will most likely fail in a short period of time under system pressure.

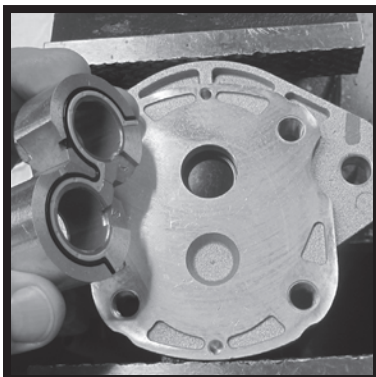

**8)** Assemble the front thrust block into the mounting flange, sealing parts can be fixed with grease. Orientation is rotation sensitive for pumps!

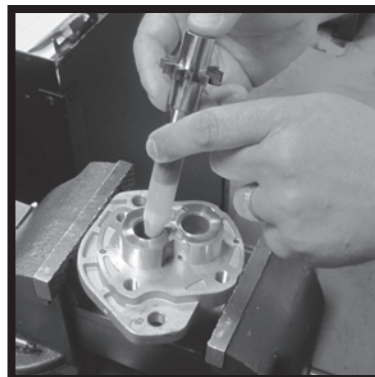

**9)** Slide the mylar shaft seal sleeve over the drive shaft. Lubricate the sleeve with grease to lubricate the shaft seal during assembly.

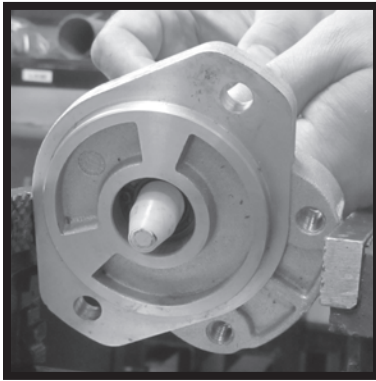

**10)** Insert shaft fully through mounting flange and remove sleeve.

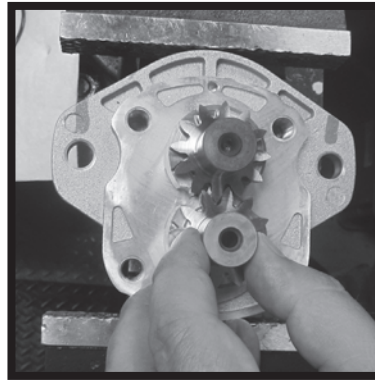

**11)** Install idler gear into thrust block and mounting flange.

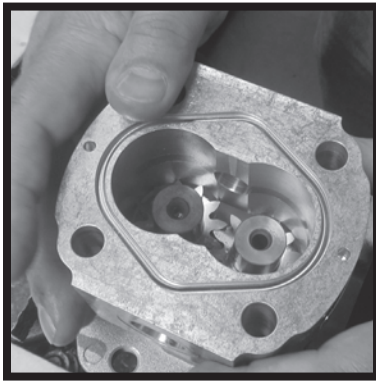

**12)** Install gear housing.

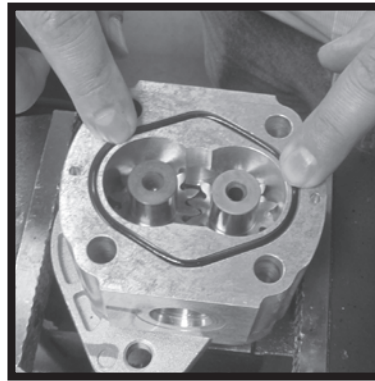

**13)** Install section seal. Use grease to hold into groove.

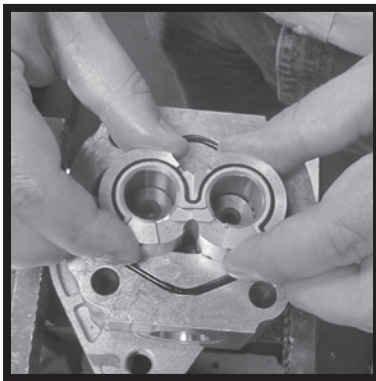

**14)** Install rear thrust block. Direction is important.

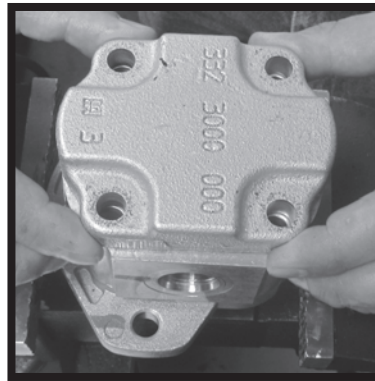

**15)** Install port end cover.

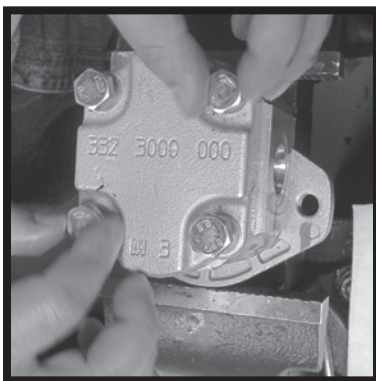

**16)** Install hardware (bolts and washers). Thread the fasteners into the mounting flange and tighten alternately or cross corner. Torque diagonally opposed fasteners to correct torque. Do not lubricate fastener threads before assembly.

**FASTENER TORQUE**

<b>PGP/PGM505</b>	<b>23 lb-ft</b>	<b>31 Nm</b>
<b>PGP/PGM511</b>	<b>36 lb-ft</b>	<b>49 Nm</b>

## Guideline for acceptable wear

### Gear Housing

Wear in excess of .005" cut-out necessitates replacement of the body. Place a straight-edge across bore. If you can slip a .005 feeler gage under the straight-edge in the cut-out area, replace the body.

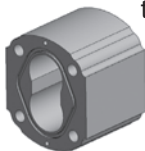

Pressure pushes the gears against the housing on the low pressure side. As the hubs and bushings wear, the cut-out becomes more pronounced. Excessive cut-out in a short period of time indicates excessive pressure or oil contamination. If the relief valve settings are within prescribed limits, check for shock pressures or tampering.

When the cut-out is moderate, .005" or less, the gear housing is in good condition and may be reused.

### Gears



Any scoring on gear hubs necessitates replacement. Scoring, grooving, or burring of the outside diameter of the teeth requires replacement. Nicking, grooving, or fretting of teeth surfaces also necessitates replacement.

### Drive Shafts



Replace if there is any wear detectable by touch in the seal area or at the drive coupling. The maximum allowable wear is .002".

Wear in the shaft seal area indicates oil contamination. Wear or damage to splines, keys, or keyways necessitates replacement.

### Bushing Blocks



The bushing blocks seal the gear section at the sides of the gears. Wear here will allow internal slippage, that is, oil will bypass within the pump.

A maximum of .002" wear is allowable.

Replace bushing blocks if they are scored, eroded or pitted. Check center of bushing blocks where the gears mesh. Erosion here indicates oil contamination. Pitted bushing blocks indicate cavitation or oil aeration. Discolored balance plates indicate overheating, likely due to insufficient oil.

505  1 piece

511  2 pieces

### Seals and Gaskets



Replace all rubber and polymer seals, including all "O" rings, thrust block channel seals, shaft seal and gasket seals.

### Checks



Examine the checks, if unit has them, in the mounting flange to make sure that they are tight, and free of contamination.



## Hydraulic Oil Recommendation

When choosing your Hydraulic Oil, duty cycle and oil temperature must be factored in to optimize your system performance. Since hydraulic systems often work under extreme temperature changes, especially in moderate to severe duty cycles, the lubrication qualities of the oil in tight tolerance components is even more critical.

Viscosity choice is always a compromise; the fluid must be thin enough to flow easily but thick enough to seal and maintain a lubricating film between bearing and sealing surfaces. This film of oil helps to reduce friction and heat, which can ultimately lead to component damage.

Fluid temperature does affect viscosity. When choosing a fluid, it is important to consider the start-up and operating temperatures of the hydraulic system. In general, as the fluid warms, it gets thinner and its viscosity decreases. At the highest temperatures, the fluid must be thick enough to provide lubrication and minimize internal leakage. Low viscosity leads to the following problems:

- Higher leakage across all sealing gaps in the pump leading to lower volumetric efficiencies and heat.
- Heat will cause loss of lubrication and will create severe wear because of metal to metal contact, causing premature failure of the gears, thrust plates and bushing blocks.

The opposite is true when the fluid cools, its viscosity increases. At the lowest temperatures, the fluid must be thin enough to flow readily. High viscosity oil leads to the following problems:

- Sealing and lubrication gaps not being filled, loss of lubrication
- Filling losses occur which causes cavitation damage to the pump

Under normal operating temperatures it is recommended to keep the temperature of the hydraulic fluid in the range of 120° F to 140° F (49° C to 60° C). Fluids may break down or oxidize at high temperatures, which leads to varnish or sludge deposits in the system and also reduces lubricity and results in reduced life of the unit. As a rule of thumb, operating temperatures over 176°F (80° C) reduce the service life by half for every 50° F (10° C) temperature increase, and should be avoided.

## Petroleum Oils (Mineral-Based)

### Viscosity Recommendations

- Optimum operating viscosity is considered to be about 100 SUS (20 cSt).
- Minimum approximately 50 - 60 SUS ( 7.5 - 10 cSt )  
Maximum at start up: approximately 7500 SUS (1600 cSt)

### Recommended Viscosity Grades

Grade	Viscosity at 100°F (40°C)	Viscosity at 210°F (100°C)
ISO 32	165 SUS (32 cSt)	44 SUS (5 cSt)
ISO 46	240 SUS (46 cSt)	49 SUS (7 cSt)
SAE 10	150 SUS (32 cSt)	41 SUS (4 cSt)
SAE 20	300 SUS (71 cSt)	51 SUS (7 cSt)

### Other Desirable Properties

Viscosity Index: 90 minimum  
Aniline Point: 175 minimum

### Additives Usually Recommended

Rust and Oxidation (R & O) Inhibitors  
Foam Depressant

**Note:** Antiwear (AW) additives are not necessarily recommended. In some instances the presence of zinc compounds can actually be harmful to copper, bronze, or brass components used in the system. The use of AW oil is optional with our gear units.

### General Recommendations

High quality hydraulic oils are essential for satisfactory performance and long life of any hydraulic system. Such oils are usually prepared from highly refined, turbine oil stocks with which select additives are compounded. We suggest following the manufacturer's specifications or the recommendations of a reputable oil supplier for the specific oil requirements on your machine.

A high viscosity oil will generally give better performance and life than a thin oil. Oil of around 100 SUS (20 cSt) will give optimum performance. Your selection should be as near to optimum as possible at operating temperature but not so heavy at start-up as to cause cavitation. Cold start-up procedures which allow the use of heavier oils should prove worthwhile by increasing pump life. The oil must be clean and contain less than 0.1% water.

### Operating Temperature

The optimum oil operating temperature is in the range of 120°-140°F (49°-60°C). Oil operating temperature should not exceed 200°F (93°C) with a maximum of 180°F (82°C) generally recommended. If the oil temperature will be above 180°F (82°C) for significant periods of time, then Viton (FKM) seals should be used. High temperatures may result in rapid oil deterioration and may point out the need for an oil cooler or a larger reservoir. The nearer to optimum temperature, the longer the service life will be of the oil, pump and other components.

### Cold Weather Operation

Oils for use in cold weather should have a viscosity not exceeding 7500 SUS (1620 cSt) at the minimum start up temperature and a pour point of at least 20°F (7° C) below that temperature. Experience on the Alaskan North Slope has been satisfactory without using special oils or fluids. Start-up procedures must allow for a gradual warm-up and equipment should not be operated at full pressure until the oil reaches a reasonably fluid state.

### Inlet Vacuum

Vacuum measured at the inlet port of the pump generally should not exceed 5 in. (13 cm) Hg. Higher vacuum can result in cavitation which may severely damage the pump. A usually acceptable rule of thumb is that the inlet line velocity should not exceed 8 fps (2.5 m/s). A long inlet line or the use of several fittings may necessitate increasing the line size. We suggest that each inlet port of a tandem pump have its own line from the reservoir.

### Reservoir

Reservoir capacity in gallons should at least equal total pump output in GPM. When filling the reservoir, oil should pass through a 100-mesh screen. Pour only clean oil from clean containers into the reservoir. The reservoir should have a breather to allow air in or out. The filler cap and breather should be sealed to prevent moisture from entering. A hydraulic oil water content of as little as 0.1% can cause damage to hydraulic components.

### Filtration

Good filtration assures improved service life at today's high operating pressures. System filtration is recommended that will maintain a contamination level according to ISO 4406: 21/19/16 for 2000 psi (140 bar), 19/17/14 for 3000 psi (210 bar) and 17/15/12 for 4000 psi (275 bar). The specific filter recommendation should come from your equipment manufacturer or filter supplier.

A 100 mesh screen should generally be used in the suction line leading to the pump. It should be of sufficient size to handle twice the pump capacity. The screen must be cleaned and checked regularly to avoid pump and system damage.

Oil and filters should be changed on a regular schedule and the system flushed in accordance with the original equipment manufacturer's recommendations. Reservoir air breather filters should be cleaned periodically.

***Filtration is not a substitute for practicing cleanliness and proper preventive maintenance***

**Water Base Fire Resistant Fluids**

Two types of water base fluids (WBF) may be used with our gear pumps and motors.

Both types of WBF come in various viscosity grades. Select the grade best suited to the equipment and its operation in terms of pressure, speed, temperature, duty cycle, etc. The fluid used should be recommended by the O.E.M. or a reputable fluid supplier

Operations outside the range of 400 to 2000 rpm and over 3000 psi (2000/2500 psi in the wider gear widths) should be reviewed with your Parker sales representative

**Water-in Oil (60/40) invert Emulsions**

Invert emulsions are approved for use with our bushing style pumps at pressures up to 3000 psi or 500 psi below catalog rated pressures, whichever is lower

**Water Glycol Solutions**

Water glycol solutions of the types normally used in hydrostatic systems are recommended for use with our bushing style pumps. These consist of about 60% glycol and about 40% water with additives to improve lubricity and other characteristics. Pressures up to 3000 psi are approved, depending on the gear width.

**WBF Filtration**

Filtration that seems to give the best results consists of a 100-mesh inlet screen and a return line filter. For water base fluids, the inlet screen should be sized up three to four times the pump capacity. The return line filter should be of a rating and size recommended by the fluid and filter manufacturers to achieve a recommended ISO contamination level

**Note:** Finer filtration may be required by other components in the system

**High Water Base Fluids (HWBF)**

The use of 95/5 emulsion is not recommended

**Comments On The Use Of Other Oils And Fluids**

**Biodegradable Oil (Vegetable-Based)**

Oils of this type with properties similar to recommended petroleum oils may be used. Performance, pressure ratings and durability are not adversely affected in bushing style pumps.

**Automatic Transmission Fluid (ATF)**

In general these oils have low viscosity and may be used only at reduced operating pressures and oil temperatures

**Diesel Fuel, Kerosene, Coal Oil**

Although sometimes used as a dilutant for cold weather operations, their use is not recommended because they are insufficiently refined products

**Transformer Oil**

Sometimes used for extremely cold weather operation. It is not generally recommended as it becomes too thin at normal operating temperatures. Oil to U.S. Military Spec MIL-H-5606 is in this category.

**OPERATING LIMITS  
GENERALLY RECOMMENDED  
WITH VARIOUS FLUIDS**

<b>Fluid:</b>	<b>Max.Operating Temp.</b>	<b>Max. Inlet Line Velocity</b>	<b>Max. Inlet Vacuum</b>
Petroleum Oil	180°F(82°C)	8 fps(2.5m/s)	5" (13cm) Hg
WIO Emulsion	150°F(65°C)	4 fps (1.2m/s)	0" (0cm) Hg
Water Glycol	150°F(65°C)	4 fps (1.2m/s)	0" (0cm) Hg

**Note:** These figures represent generally accepted maximums and will not prove satisfactory in all installations. For very severe duty cycles, it will likely be advantageous to design and operate the system at something less than these maximum limits

- DO NOT USE ANY TYPE OF FLUID NOT RECOMMENDED IN THIS BULLETIN WITHOUT FIRST CONSULTING OUR PRODUCT SUPPORT DEPT
- OBTAIN YOUR FINAL FLUID RECOMMENDATION FROM YOUR FLUID SUPPLIER



## **Recommended Start-up Procedure For New or Rebuilt Pump**

Before installing a new or rebuilt pump, back off the main relief valve until the spring tension on the adjusting screw is relieved. This will avoid the possibility of immediate damage to the replacement unit in the event that the relief valve setting had been increased beyond the recommended operating pressure, prior to removing the old unit.

Before connecting any lines to the pump, fill all ports with clean oil to provide initial lubrication. This is particularly important if the unit is located above the oil reservoir.

After connecting the lines and mounting the replacement unit, operate the pump at least two minutes at no load and at low rpm (400 min.) During this break-in period, the unit should run free and not develop an excessive amount of heat. If the unit operates properly, speed and pressure can then be increased to normal operating settings.

Reset the main relief valve to its proper setting while the pump is running at maximum operating engine (motor) speed for the vehicle.

ALWAYS USE AN ACCURATE GAUGE  
WHEN ADJUSTING THE RELIEF VALVE  
PRESSURE SETTING.

## Recommended Test Procedure

Make certain that there is an adequate supply of oil for the pump; at least one gallon of oil for each gpm of pump capacity.

If one section of a tandem pump is being tested, make sure that all other sections not being tested are adequately supplied with oil. If any of the other sections run dry, or if plugs are left in ports, serious and permanent damage will result.

The oil should be a good quality hydraulic oil rated at 150 SSU at 100° F., with the oil temperature held at 120° F. plus or minus 50° F. (Test procedures are described in detail in SAE handbooks; see Hydraulic Power Pump Test Procedure, SAE J745c.)

The feed line must be of adequate size with no more than 5" mercury vacuum adjacent to the pump inlet. As a rule, the feed line must provide a feed flow velocity not in excess of 8 feet per second.

Feeding hot oil into a cold pump may cause the pump to seize. Jog the pump by momentarily starting and stopping repeatedly the driving engine or motor to gradually equalize pump and oil temperatures.

Run the pump at least two minutes at no load and moderate speed (not over 1500 rpm). If the pump becomes excessively hot, shut down immediately and locate the problem source.

Gradually increase pressure on pump, in 500 psi increments until the desired test pressure has been reached. This should take about five minutes.

Delivery should run close to rated catalog performance figures, which are averaged from testing several pumps. A 5% lower reading may be used as a rated minimum if new or relatively new parts have been used. When rebuilding the pump with parts from the original pump, which, while worn, appear satisfactory for reuse, a 10% or 15% lower reading may be permitted, depending on the performance expected from the equipment. One's own experience will prove the best guide here.

At test speeds other than 1800 rpm, gpm delivery will vary almost proportionately, but the same (drop-off) figures should be used.

Be sure to run the pump in the direction for which it was designed and built. Driving the pump in the wrong direction will build up pressure behind the shaft seal, damaging it and necessitating replacement.

After completing testing procedures, the pump is ready for installation and immediate duty operation on equipment. Again, it must be remembered that to prevent seizure, hot oil must not be fed into a cold pump.

## Offer of Sale

The items described in this document and other documents or descriptions provided by Parker Hannifin Corporation, its subsidiaries and its authorized distributors are hereby offered for sale at prices to be established by Parker Hannifin Corporation, its subsidiaries and its authorized distributors. This offer and its acceptance by any customer ("Buyer") shall be governed by all of the following Terms and Conditions. Buyer's order for any such items, when communicated to Parker Hannifin Corporation, its subsidiary or an authorized distributor ("Seller") verbally or in writing, shall constitute acceptance of this offer.

**1. Terms and Conditions of Sale:** All descriptions, quotations, proposals, offers, acknowledgments, acceptances and sales of Seller's products are subject to and shall be governed exclusively by the terms and conditions stated herein. Buyer's acceptance of any offer to sell is limited to these terms and conditions. Any terms or conditions in addition to, or inconsistent with those stated herein, proposed by Buyer in any acceptance of an offer by Seller, are hereby objected to. No such additional, different or inconsistent terms and conditions shall become part of the contract between Buyer and Seller unless expressly accepted in writing by Seller. Seller's acceptance of any offer to purchase by Buyer is expressly conditional upon Buyer's assent to all the terms and conditions stated herein, including any terms in addition to, or inconsistent with those contained in Buyer's offer. Acceptance of Seller's products shall in all events constitute such assent.

**2. Payment:** Payment shall be made by Buyer net 30 days from the date of delivery of the items purchased hereunder. Amounts not timely paid shall bear interest at the maximum rate permitted by law for each month or portion thereof that the Buyer is late in making payment. Any claims by Buyer for omissions or shortages in a shipment shall be waived unless Seller receives notice thereof within 30 days after Buyer's receipt of the shipment.

**3. Delivery:** Unless otherwise provided on the face hereof, delivery shall be made F.O.B. Seller's plant. Regardless of the method of delivery, however, risk of loss shall pass to Buyer upon Seller's delivery to a carrier. Any delivery dates shown are approximate only and Seller shall have no liability for any delays in delivery.

**4. Warranty:** Seller warrants that the items sold hereunder shall be free from defects in material or workmanship for a period of 18 months from date of shipment from Parker Hannifin Corporation. **THIS WARRANTY COMPRISES THE SOLE AND ENTIRE WARRANTY PERTAINING TO ITEMS PROVIDED HEREUNDER. SELLER MAKES NO OTHER WARRANTY, GUARANTEE, OR REPRESENTATION OF ANY KIND WHATSOEVER. ALL OTHER WARRANTIES, INCLUDING BUT NOT LIMITED TO, MERCHANTABILITY AND FITNESS FOR PURPOSE, WHETHER EXPRESS, IMPLIED, OR ARISING BY OPERATION OF LAW, TRADE USAGE, OR COURSE OF DEALING ARE HEREBY DISCLAIMED. NOTWITHSTANDING THE FOREGOING, THERE ARE NOWARRANTIES WHATSOEVER ON ITEMS BUILT OR ACQUIRED WHOLLY OR PARTIALLY, TO BUYER'S DESIGNS OR SPECIFICATIONS.**

**5. Limitation Of Remedy: SELLER'S LIABILITY ARISING FROM OR IN ANY WAY CONNECTED WITH THE ITEMS SOLD OR THIS CONTRACT SHALL BE LIMITED EXCLUSIVELY TO REPAIR OR REPLACEMENT OF THE ITEMS SOLD OR REFUND OF THE PURCHASE PRICE PAID BY BUYER, AT SELLER'S SOLE OPTION. IN NO EVENT SHALL SELLER BE LIABLE FOR ANY INCIDENTAL, CONSEQUENTIAL OR SPECIAL DAMAGES OF ANY KIND OR NATURE WHATSOEVER, INCLUDING BUT NOT LIMITED TO LOST PROFITS ARISING FROM OR IN ANY WAY CONNECTED WITH THIS AGREEMENT OR ITEMS SOLD HEREUNDER, WHETHER ALLEGED TO ARISE FROM BREACH OF CONTRACT, EXPRESS OR IMPLIED WARRANTY, OR IN TORT, INCLUDING WITHOUT LIMITATION, NEGLIGENCE, FAILURE TO WARN OR STRICT LIABILITY.**

**6. Changes, Reschedules and Cancellations:** Buyer may request to modify the designs or specifications for the items sold hereunder as well as the quantities and delivery dates thereof, or may request to cancel all or part of this order, however, no such requested modification or cancellation shall become part of the contract between Buyer and Seller unless accepted by Seller in a written amendment to this Agreement. Acceptance of any such requested modification or cancellation shall be at Seller's discretion, and shall be upon such terms and conditions as Seller may require.

**7. Special Tooling:** A tooling charge may be imposed for any special tooling, including without limitation, dies, fixtures, molds and patterns, acquired to manufacture items sold pursuant to this contract. Such special tooling shall be and remain Seller's property notwithstanding payment of any charges by Buyer. In no event will Buyer acquire any interest in apparatus belonging to Seller which is utilized in the manufacture of the items sold hereunder, even if such apparatus has been specially converted or adapted for such manufacture and notwithstanding any charges paid

by Buyer. Unless otherwise agreed, Seller shall have the right to alter, discard or otherwise dispose of any special tooling or other property in its sole discretion at any time.

**8. Buyer's Property:** Any designs, tools, patterns, materials, drawings, confidential information or equipment furnished by Buyer or any other items which become Buyer's property, may be considered obsolete and may be destroyed by Seller after two (2) consecutive years have elapsed without Buyer placing an order for the items which are manufactured using such property. Seller shall not be responsible for any loss or damage to such property while it is in Seller's possession or control.

**9. Taxes:** Unless otherwise indicated on the face hereof, all prices and charges are exclusive of excise, sales, use, property, occupational or like taxes which may be imposed by any taxing authority upon the manufacture, sale or delivery of the items sold hereunder. If any such taxes must be paid by Seller or if Seller is liable for the collection of such tax, the amount thereof shall be in addition to the amounts for the items sold. Buyer agrees to pay all such taxes or to reimburse Seller therefore upon receipt of its invoice. If Buyer claims exemption from any sales, use or other tax imposed by any taxing authority, Buyer shall save Seller harmless from and against any such tax, together with any interest or penalties thereon which may be assessed if the items are held to be taxable.

**10. Indemnity For Infringement of Intellectual Property Rights:** Seller shall have no liability for infringement of any patents, trademarks, copyrights, trade dress, trade secrets or similar rights except as provided in this Part 10. Seller will defend and indemnify Buyer against allegations of infringement of U.S. Patents, U.S. Trademarks, copyrights, trade dress and trade secrets (hereinafter 'Intellectual Property Rights'). Seller will defend at its expense and will pay the cost of any settlement or damages awarded in an action brought against Buyer based on an allegation that an item sold pursuant to this contract infringes the Intellectual Property Rights of a third party. Seller's obligation to defend and indemnify Buyer is contingent on Buyer notifying Seller within ten (10) days after Buyer becomes aware of such allegations of infringement, and Seller having sole control over the defense of any allegations or actions including all negotiations for settlement or compromise. If an item sold hereunder is subject to a claim that it infringes the Intellectual Property Rights of a third party, Seller may, at its sole expense and option, procure for Buyer the right to continue using said item, replace or modify said item so as to make it noninfringing, or offer to accept return of said item and return the purchase price less a reasonable allowance for depreciation. Notwithstanding the foregoing, Seller shall have no liability for claims of infringement based on information provided by Buyer, or directed to items delivered hereunder for which the designs are specified in whole or part by Buyer, or infringements resulting from the modification, combination or use in a system of any item sold hereunder. The foregoing provisions of this Part 10 shall constitute Seller's sole and exclusive liability and Buyer's sole and exclusive remedy for infringement of Intellectual Property Rights.

If a claim is based on information provided by Buyer or if the design for an item delivered hereunder is specified in whole or in part by Buyer, Buyer shall defend and indemnify Seller for all costs, expenses or judgments resulting from any claim that such item infringes any patent, trademark, copyright, trade dress, trade secret or any similar right.

**11. Force Majeure:** Seller does not assume the risk of and shall not be liable for delay or failure to perform any of Seller's obligations by reason of circumstances beyond the reasonable control of Seller (hereinafter 'Events of Force Majeure'). Events of Force Majeure shall include without limitation, accidents, acts of God, strikes or labor disputes, acts, laws, rules or regulations of any government or government agency, fires, floods, delays or failures in delivery of carriers or suppliers, shortages of materials and any other cause beyond Seller's control.

**12. Entire Agreement/Governing Law:** The terms and conditions set forth herein, together with any amendments, modifications and any different terms or conditions expressly accepted by Seller in writing, shall constitute the entire Agreement concerning the items sold, and there are no oral or other representations or agreements which pertain thereto. This Agreement shall be governed in all respects by the law of the State of Ohio. No actions arising out of the sale of the items sold hereunder or this Agreement may be brought by either party more than two (2) years after the cause of action accrues.

9/91-P



## About Parker Hannifin Corporation

Parker Hannifin is a leading global motion-control company dedicated to delivering premier customer service. A Fortune 500 corporation listed on the New York Stock Exchange (PH), our components and systems comprise over 1,400 product lines that control motion in some 1,000 industrial and aerospace markets. Parker is the only manufacturer to offer its customers a choice of hydraulic, pneumatic, and electromechanical motion-control solutions. Our Company has the largest distribution network in its field, with over 7,500 distributors serving more than 350,000 customers worldwide.

## Parker's Charter

To be a leading worldwide manufacturer of components and systems for the builders and users of durable goods. More specifically, we will design, market and manufacture products controlling motion, flow and pressure. We will achieve profitable growth through premier customer service.

## Product Information

North American customers seeking product information, the location of a nearby distributor, or repair services will receive prompt attention by calling the Parker Product Information Center at our toll-free number: 1-800-C-PARKER (1-800-272-7537). In the UK, a similar service is available by calling 0500-103-203.

### The Aerospace Group

is a leader in the development, design, manufacture and servicing of control systems and components for aerospace and related high-technology markets, while achieving growth through premier customer service.



### The Climate & Industrial Controls Group

designs, manufactures and markets system-control and fluid-handling components and systems to refrigeration, air-conditioning and industrial customers worldwide.



### The Fluid Connectors Group

designs, manufactures and markets rigid and flexible connectors, and associated products used in pneumatic and fluid systems.

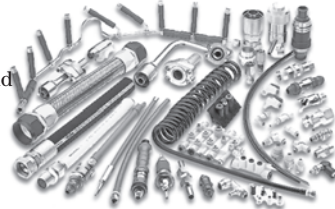

**The Seal Group** designs, manufactures and distributes industrial and commercial sealing devices and related products by providing superior quality and total customer satisfaction.



### The Hydraulics Group

designs, produces and markets a full spectrum of hydraulic components and systems to builders and users of industrial and mobile machinery and equipment.



### The Filtration Group

designs, manufactures and markets quality filtration and clarification products, providing customers with the best value, quality, technical support, and global availability.



### The Automation Group

is a leading supplier of pneumatic and electro-mechanical components and systems to automation customers worldwide.

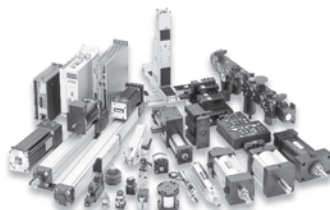

### The Instrumentation Group

is a global leader in the design, manufacture and distribution of high-quality critical flow components for worldwide process instrumentation, ultra-high-purity, medical and analytical applications.



# Sales Offices Worldwide

## **North America**

**Gear Pump Division**

**Headquarters**

**101 Canterbury Road**

**Kings Mountain, NC 28086**

phone 704 730 2000

fax 704 730 5832

**Gear Pump Division Facility**

**2701 Intertech Drive**

**Youngstown, OH 44509**

phone 330 270 6000

fax 330 270 6185

---

Supercode Catalog HY09-SM500/US, RS 05/12



Parker Hannifin Corporation

**Gear Pump Division**

101 Caterbury Road

Kings Mountain, NC USA

phone 704 739 9781

fax 704 739 2269

[www.parker.com](http://www.parker.com)

Your Local Authorized Parker Distributor