

EATON

Hydraulics

Model 70160 Variable Displacement Piston Pump

Repair Information

 www.khadamathydraulic.com
Tell: 021-55882749
Tell: 021-33488178
Fax: 021-33488105

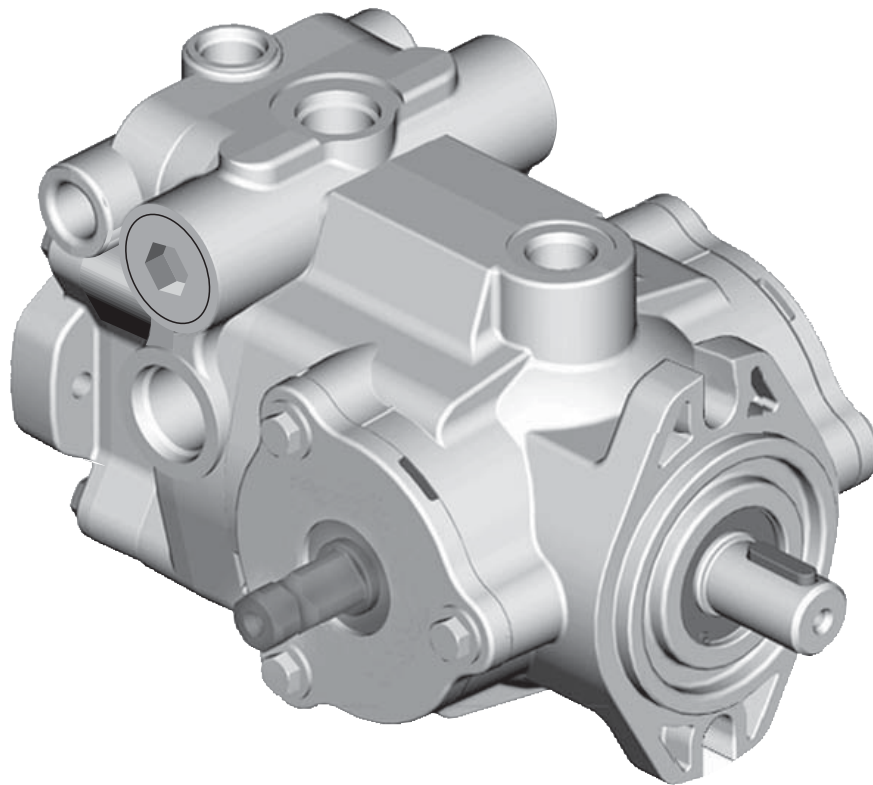

Introduction

Table of Contents

Introduction	2
Identification	3
Tools Required	3
Parts Drawing	4 - 5
Parts List	6 - 7
Repair information	
Disassembly	8 - 10
Reassembly	11 - 12
Fault - Logic Troubleshooting	13 - 17
Start-up Procedure	18

Introduction

This manual provides service information for Eaton Models 70160 variable displacement piston pumps. Step by step instructions for the complete disassembly, inspection, and reassembly of the pump are given. The following recommendations should be followed to insure successful repairs.

- Remove the pump from the application.
- Cleanliness is extremely important.
- Clean the port areas thoroughly before disconnecting the hydraulic lines.
- Plug the pump ports and cover the open hydraulic lines immediately after they're disconnected.
- Drain the oil and clean the exterior of the pump before making repairs.
- Wash all metal parts in clean solvent.
- Use compressed air to dry the parts. Do not wipe them dry with paper towels or cloth.
- Compressed air should be filtered and moisture free.
- Always use new seals when reassembling hydraulic pumps.
- Lubricate the new rubber seals with a petroleum jelly (Vaseline®) before installation.
- Torque all bolts over gasketed joints, then repeat the torquing sequence to makeup for gasket compression.
- Verifying the accuracy of pump repairs on an authorized test stand is essential.

Identification Numbers - Manually Variable Displacement Piston Pump

Stamped on each unit's mounting flange.

- A - Product Number Description
70160 = Single Piston Pump
78162 = Single Piston Pump with Gear Pump
78161 = Tandem Piston Pumps
78163 = Tandem Piston Pumps with Gear Pump
- B - Sequential Numbering
- C - Engineering Design Code

Single Pump - Product Number:

7 0 1 6 0 - R A A - 0 3

A B C

Tandem Pumps - Product Number:

7 8 1 6 3 - R A B - 0 3

A B C

Serial Number Code:

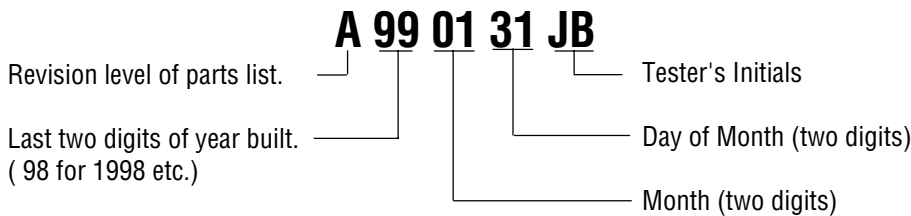

Each order must include the following information.

1. Product and/or Part Number
2. Serial Number Code
3. Part Name
4. Quantity

Tools Required

- 1/2, 9/16, 7/8 & 1-1/8 in. sockets and/or end wrenches
- Torque wrench (136 N-m [100 lbf-ft] capacity)
- Ratchet wrench
- 5/16 in. and 7/16 Allen wrenches or bit sockets
- Internal and external retaining ring pliers
- Small screwdrivers (2)
- Hammer (soft face)
- Light Petroleum Jelly
- Seal driver or similar tool

Parts Drawing

Pump drawn below is typical of a righthand rotation pump.

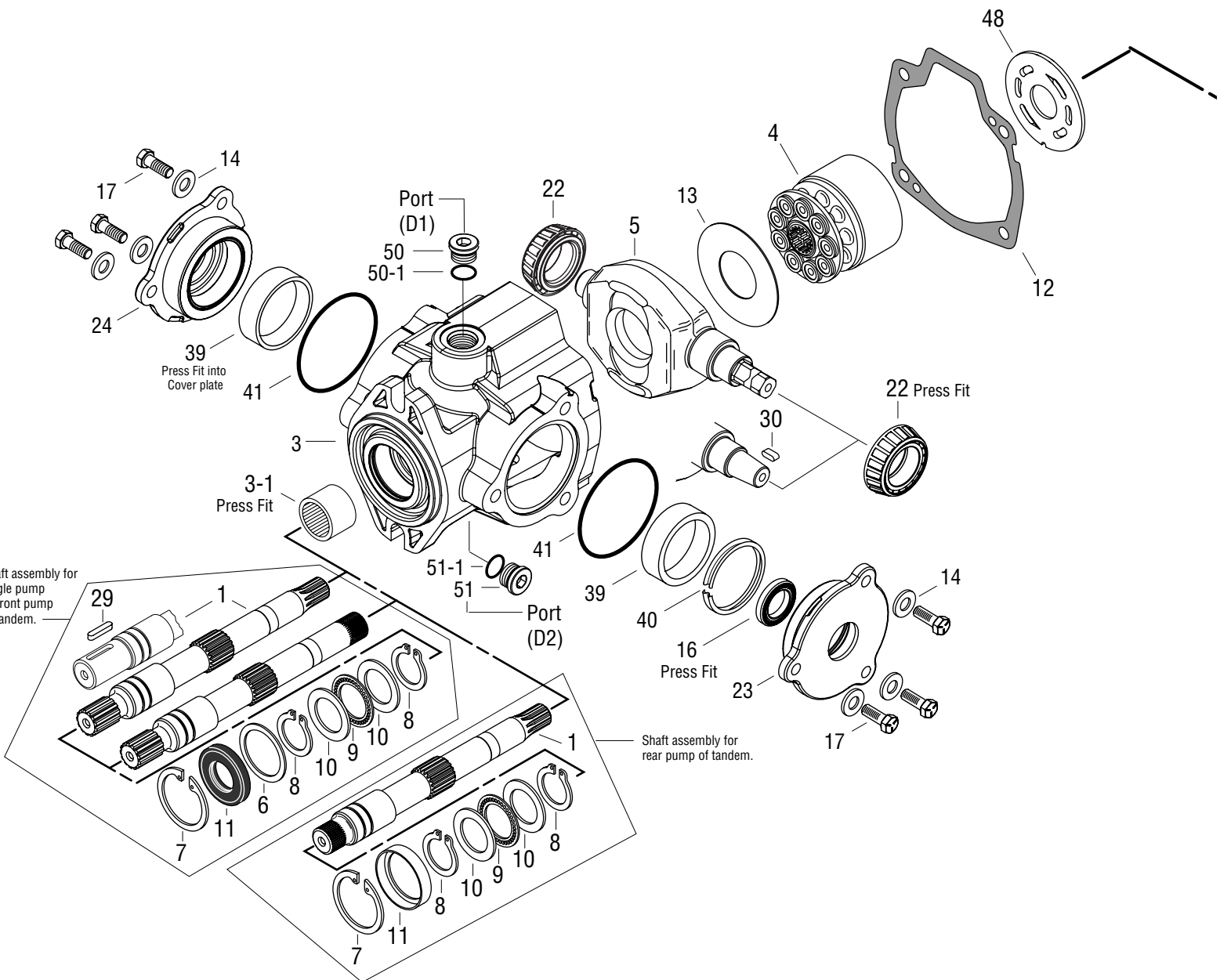

Parts Drawing

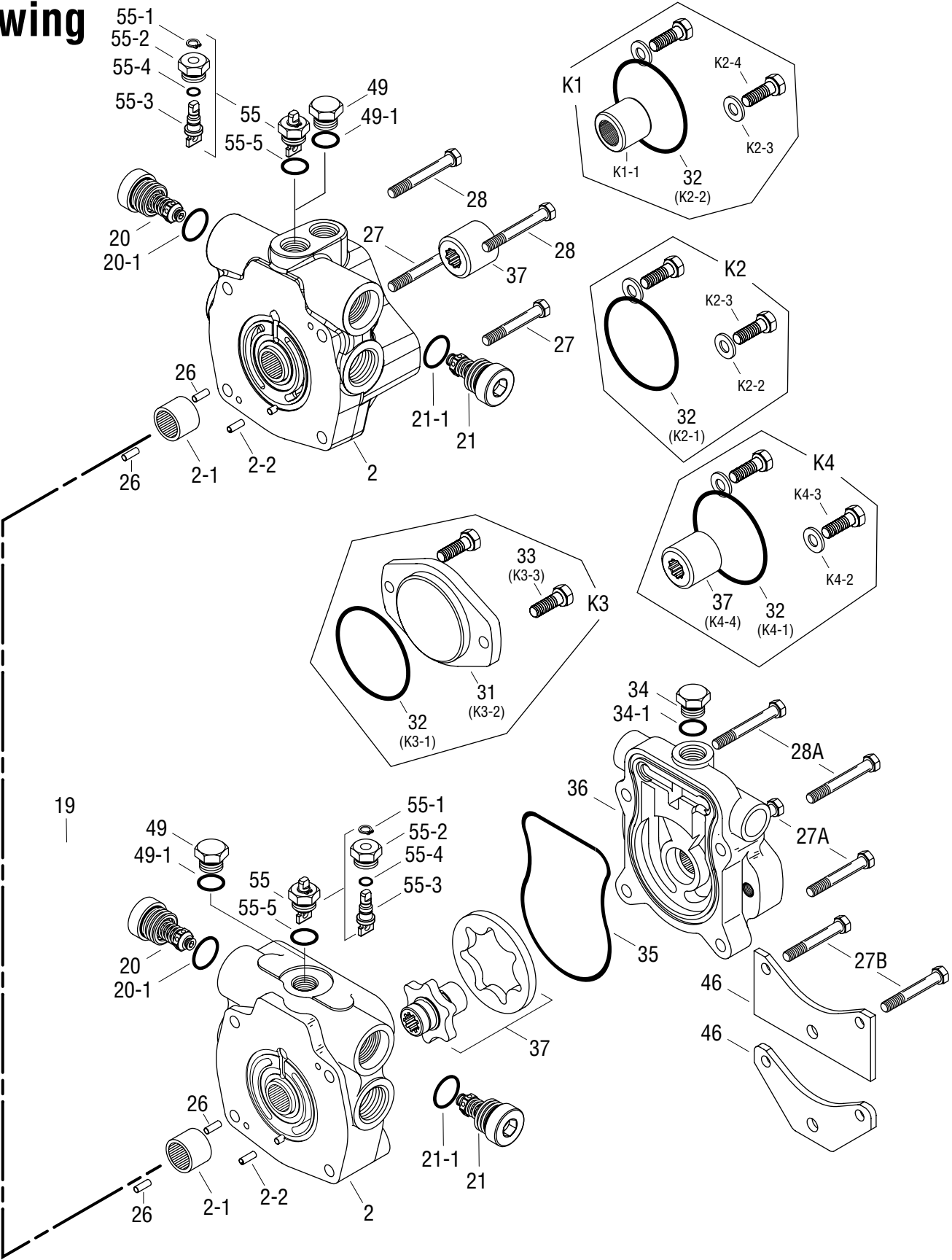

Parts List

Item	Qty.	Description
1	1	Drive Shaft
2	1	Backplate Assembly
3	1	Housing Assembly
4	1	Rotating Kit Assembly
5	1	Camplate
6	1	Washer
+ 7	1	Retaining Ring
+ 8	2	Retaining Ring
9	1	Thrust Bearing
10	2	Bearing Race
+ 11	1	Shaft Seal, Drive
11	1	Viton Shaft Seal, Drive
11	1	Spacer
+ 12	1	Housing Gasket
13	1	Camplate Insert
14	6	Washer
+ 16	1	Shaft Seal, Trunnion
17	6	Screw, Cap
20	1	for Port "C" Relief Valve S/A
+ 20-1	1	O-ring, 2.95 mm Dia. x 23,46 mm ID. [.116 in. Dia. x .924 in. ID.]
21	1	for Port "D" Relief Valve S/A
+ 21-1	1	O-ring, 2.95 mm Dia. x 23,46 mm ID. [.116 in. Dia. x .924 in. ID.]
22	2	Cone Bearing
23	1	Coverplate Sub Assembly
24	1	Coverplate Sub Assembly
26	2	Dowel Pin
27	2	Cap Screws, 5/16-18, 50.8 mm [2 in.] Long
27A	2	Cap Screws, 5/16-18, 82.6 mm [3.25 in.] Long
27B	2	Cap Screws, 5/16-18, 88.9 mm [3.5 in.] Long
28	2	Cap Screws, 5/16-18, 63.5 mm [2.5 in.] Long
28A	2	Cap Screws, 5/16-18, 95.3 mm [3.75 in.] Long
28B	2	Cap Screws, 5/16-18, 101.6 mm [4.00 in.] Long
29	1	Key, Drive Shaft
30	1	Key, Tapered Arm
31	1	Cover Plate (In K3 kit)
+ 32	1	O-ring (In K1, K2, K3, & K4 kit)
33	2	Cap Screws, Cover Plate (In K3 kit)
34	1	Plug Assembly
+ 34-1	1	O-ring, 2.21 mm Dia. x 16.36 mm ID. [.087 in. Dia. x .644 in. ID.]
+ 35	1	Molded O-ring
36	1	Charge Pump Adaptor
37	1	Gerotor set and coupler sub-assembly
37	1	9 tooth coupler (In Kit 4)
37	1	11 tooth coupler (In Kit 5)
39	2	Cup, Bearing
40	1	Ring, Crush
41	2	O-ring, 2.38 mm Dia. x 66.68 mm I.D. [.0937 in. Dia. x 2.625 in. I.D.]
42	4	Washer
46	1	Mounting Bracket, Square shaped
46	1	Mounting Bracket, "V" shaped
48	1	Valve Plate

Parts List

Item	Qty.	Description
		Righthand (CW) Rotation Lefthand (CCW) Rotation
49	1	Plug Assembly
49-1	1	Plug Assembly
+ 50-1	1	O-ring, 1.98 mm Dia. x 11.89 mm ID. [.078 in. Dia. x .468 in. ID.]
51	1	Plug Assembly
+ 51-1	1	O-ring, 1.98 mm Dia. x 11.89 mm ID. [.078 in. Dia. x .468 in. ID.]
55	1	Bypass Valve sub-assembly
+ 55-1	1	Retaining Ring
55-2	1	Separator Plug
55-3	1	Separator
+ 55-4	1	O-ring, 1.59 mm Dia. x 9.53 mm I.D. [.0625 in. Dia. x .375 in. I.D.]
+ 55-5	1	O-ring, 2.46 mm Dia. x 19.18 mm I.D. [.097 in. Dia. x .755 in. I.D.]

Mounting Kits

K1	1	Tandem Piston Pump Mounting Kit
K1-1	1	35T Coupler, 36.8 mm [1.45 in.] long
K1-2	1	O-ring, 1.59 mm Dia. x 101.6 mm ID. [.0625 in. Dia. x 4 in. ID.]
K1-3	2	Cap Screws
K1-4	2	Washer
K2	1	Gear Pump Mounting Kit
K2-1	1	O-ring, 1.59 mm Dia. x 82.55 mm ID. [.0625 in. Dia. x 3.25 in. ID.]
K2-2	2	Washer
K2-3	2	Cap Screws
K3	1	Cover Plate Kit
K3-1	1	O-ring, 1.59 mm Dia. x 82.55 mm ID. [.0625 in. Dia. x 3.25 in. ID.]
K3-2	1	Cover Plate
K3-3	2	Cap Screws
K4	1	Gear Pump Mounting Kit with Coupler
K4-1	1	O-ring, 1.59 mm Dia. x 101.6 mm ID. [.0625 in. Dia. x 4 in. ID.]
K4-2	2	Washer
K4-3	2	Cap Screws
K4-4	1	9T Coupler

Seal Repair Kit

•	1	Seal Repair Kit (see Parts Manual for part numbers)
---	---	---

Legend

+ Included in seal repair kit.

Repair Information - Disassembly

Disassembly

The following disassembly procedure applies to a single pump with or without gear pump. The repair procedure for tandem pumps, once they are separated, is basically the same. The basic configuration differences between a single and tandem pumps are the backplates, pump shafts and housing assemblies. In most cases, only the rear pump of

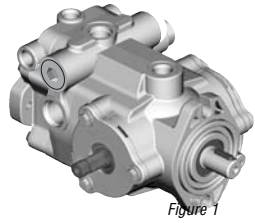

Figure 1

tandem units contain a charge pump, which is common to both the front and rear pump. The rear tandem pump does not incorporate a shaft seal.

Thoroughly clean the Eaton Model 70160 or 78162 variable displacement pump before any repairs are attempted. When working on tandem pumps, separate the front and rear pumps first.

1 Support the pump with the input shaft down. Use a 1/2 in. socket or end wrench to remove the pump adapter cover plate or gear pump (see Figure 2).



Figure 2

2 Use a pick or similar tool to remove the adapter cover plate or gear pump o-ring. (See Figure 3)

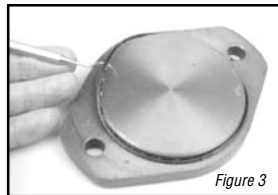

Figure 3

3 Use a 7/16 in. Allen wrench or bit socket remover to remove the charge pressure relief valve spring retainer from the pump adaptor assembly (see Figure 4).



Figure 4

4 Use a pencil magnet or similar tool to carefully remove the charge pressure spring and poppet from the pump adaptor assembly. (See Figure 5) Use caution not to drop the charge pump poppet into the pump adaptor assembly.

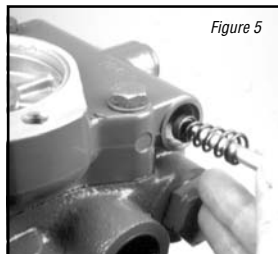

Figure 5

5 The charge pressure relief valve and poppet may be of the standard or high pressure type. The (6.9 to 10.3 bar [100 to 150 PSI]) standard spring and poppet are shown on the bottom and the optional high pressure (13.7 to 20.7 bar [200 to 300 PSI]) spring and poppet is shown on the top.

The same charge pressure relief valve spring retainer is used with either the standard or high pressure (see Figure 6).

6 Use a 7/8 in. socket or end wrench to remove the optional bypass valve assembly from the backplate (see Figure 7).

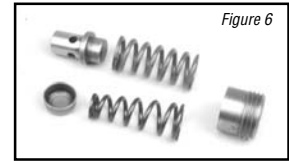

Figure 6

7 The internal seal may be replaced by first removing the small retaining ring on the end of the bypass valve. Remove and replace the o-rings (see Figure 8).

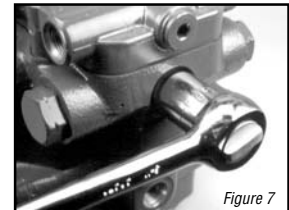

Figure 7

8 Use a 9/16 in. hex key to remove the two high pressure relief valves from the pumps backplate assembly (see Figure 9). Remove relief valve as shown from each side (see Figure 10). Each system relief valve S/A is identified by both its part number and relief valve setting as shown in Parts Information manual.

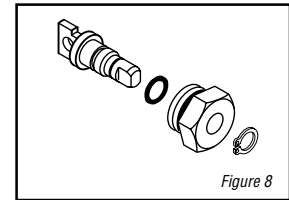

Figure 8

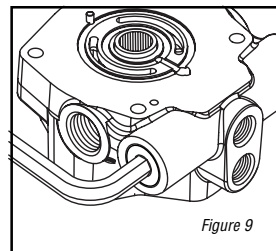

Figure 9

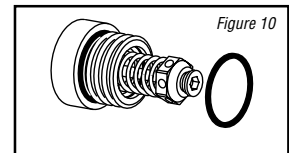

Figure 10

9 Firmly support the pump assembly. Use a 1/2 in. socket or end wrench to remove the four cap screws retaining the charge pump adapter assembly.

10 With the cap screws removed, remove the charge pump adaptor assembly from the backplate (see Figure 11).

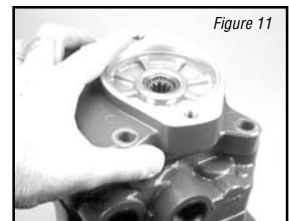

Figure 11

Note: The front pump assemblies do not have charge pump adapter assemblies.

11 Turn the adapter assembly over. Use an o-ring pick or similar tool remove the o-ring seal (see Figure 12).

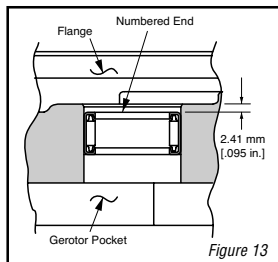

Figure 12

12 Inspect the gerotor pocket and needle bearing located in the charge pump adapter. The needles in the needle bearing must remain intact in the bearing cage.

Repair Information - Disassembly

13 When the needle bearing assembly is replaced, the numbered end of the bearing must face toward the flange side of the adapter to the dimension as shown (see Figure 13).



14 With the charge pump adapter removed, remove the charge pump outerring and inner gerotor ring assembly (see Figure 14 and 15).

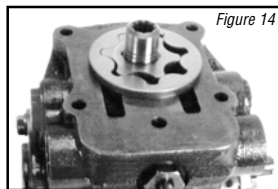

15 Charge pumps are available in two different displacements. Charge pump displacements are based on the thickness of the gerotor assembly and the depth of the pocket located in the charge pump adapter. To determine the displacement, refer to the table below.

Gerotor Pocket Depth

Displacement cm ³ /r [in ³ /r]	Depth of Pocket mm [in.]
6.9 [.42]	6.35 [.25]
13.8 [.84]	12.7 [.50]

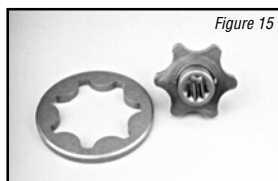

16 To separate the backplate assembly from the dowel pins in the pump housing assembly, insert two screwdrivers between backplate and housing assembly and pry upward (see Figure 16).



17 After separation, remove the backplate from the housing assembly.

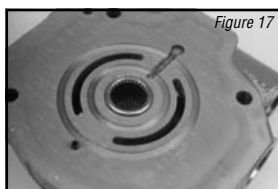

18 Turn the backplate assembly over and inspect the needle bearing. The needles in the needle bearing must remain intact in the bearing cage (see Figure 17).

19 When the needle bearing assembly is replaced, the numbered end of the bearing must face the valve plate side of the backplate to the dimension as shown (see Figure 18).

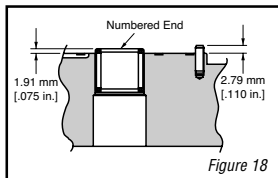

20 With the backplate removed, remove the gasket from the pump housing assembly and discard (see Figure 19).

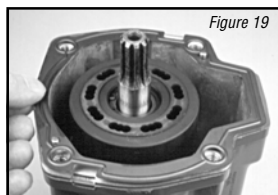

21 Remove the valve plate from the piston block assembly. Note: This valve plate may have stuck to the backplate assembly that was previously removed.

22 Valveplate directional rotation (CW or CCW) is identified by the location of the metering slots located on the face of the valve plates. Pump input rotation should always turn into the metering slots (see Figure 20). A clockwise valve plate is shown on the left and a counter clockwise valve plate is on the right.

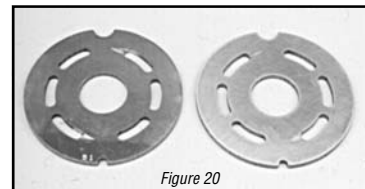

Note: Whenever pump input rotation is changed, the valve plate must be replaced along with the desired rotation charge pump adapter.

23 Remove the rotating kit assembly by carefully retaining it in the housing assembly (see Figure 21). Lift the housing and rotating kit assembly and turn over assemblies allowing the rotating kit assembly to slide down the input shaft and out of the pump housing.



24 With the rotating kit assembly removed, remove the piston assemblies, spider and spider pivot from the piston barrel. (see Figure 22).



25 Inspect the piston assemblies, spider, spider pivot and piston block. The piston block assembly usually requires no further disassembly unless the pins or block spring are damaged.

26 When any excessive wear or scratches are noted on the face of the piston block, the block assembly must be replaced (see Figure 23).



DO NOT LAP THE FACE OF PISTON BLOCK ASSEMBLY.

27 To remove the input shaft assembly, use a pair of internal snap ring pliers and remove the shaft seal retaining ring from the housing assembly (see Figure 24).



Repair Information - Disassembly

28 With the retaining ring removed, use a small press to press the shaft seal and input shaft assembly from the housing assembly.

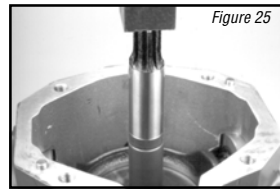

29 With the input shaft assembly removed, disassemble the assembly for inspection by removing the shaft seal, washer, retaining ring thrust washers and bearing (see Figure 26).



Note: The rear pump on tandem units uses a spacer in place of shaft seals.

30 To remove the camplate from the housing assembly, use a 9/16 in. socket or end wrench and remove the three cap screws and washers retaining the control arm cover plate assembly. Start at the cover plate with control arm (see Figure 27).

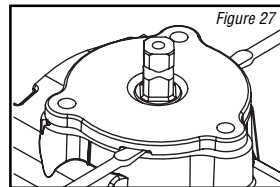

31 With the retaining cap screws removed, insert two small screwdrivers in the notches located in the cover plate assembly and pry upward. Make sure bearing cup comes off with the cover plate (see Figure 28).

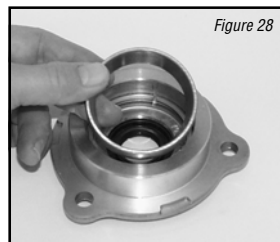

Note: The crush ring in the control arm trunnion cover does not need to be removed (see Figure 29). The only time the crush ring needs to be removed is when either the trunnion cover, the camplate assembly or the housing assembly is replaced. A shim kit is then required in the crush ring's place.

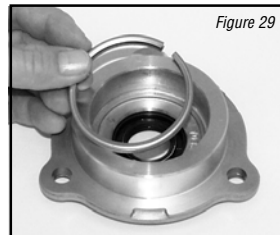

32 Reposition the pump assembly to remove opposite cover plate. The bearing cup in this cover plate is press fit and not removable. Repeat steps 30 through 31.

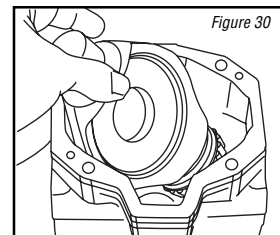

32b Remove the slip fit bearing on the non-control arm side of the camplate.

33 With housing in the upright position, slide the camplate toward the control side and lift it from the pump housing (see Figure 30).

Note: The camplate control shaft will fit out either side of the pump housing. Be sure to note on which side of the housing the control shaft protrudes before removing camplate from

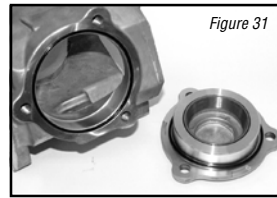

34 Use an o-ring pick or similar tool to remove the o-ring seals from the two counter-bores in the housing or the cover plates (see Figure 31).

35 To remove the control side cover plate lip seal, use a small press and press the lip seal inward (see Figure 32).

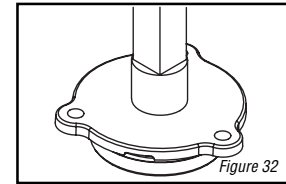

36 Remove the thrust plate from the camplate. The thrust plate is reversible and either side may face the camplate (see Figure 33).



37 Inspect the housing assembly's front needle bearing. If the needles remain in their cage and move freely, replacement usually is not required (see Figure 34).

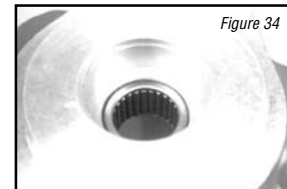

38 When the needle bearing is replaced, the numbered end of the needle bearing must face away from the housing and pressed to the dimension as shown (see Figure 35).

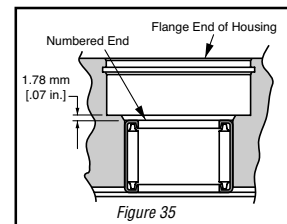

Repair Information - Reassembly

Reassembly

1 Before reassembling the pump, replace all worn and damaged parts, assemblies, seals and o-rings. Lubricate the seals and o-rings with petroleum jelly to help retain them during reassembly and to provide lubrication to the input and control shaft seals. Lubricate all finished part surfaces freely with clean hydraulic fluid to help provide start up lubrication between all rotating parts.

2 To reassemble the camplate assembly into the pump housing, tilt the camplate slightly and install the control side of the camplate through the previously noted or marked side of the housing assembly (see Figure 36).

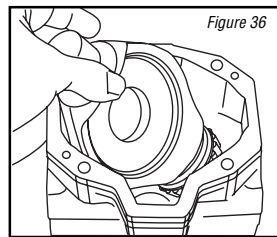

3 Lubricate the tapered bearing and reassemble it on the non-control arm side of the camplate (see Figure 37).

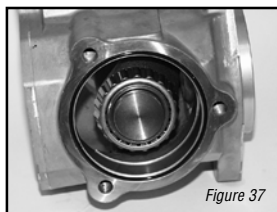

4 Lubricate and install the o-ring seal into counter-bore of housing (see Figure 37).

5 Install the trunnion cover over bearing and onto pump housing. Install the three cap screws and washers, torque screws to 39,3 Nm [29 ft-lb] (see Figure 38).

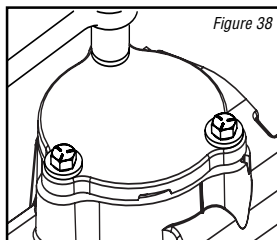

6 Lubricate and install the control arm shaft seal into the control arm cover plate. Install with the lip of the seal facing upward or to the inside of the pump (see Figure 39).

7 If the housing, trunnion covers or camplate assembly have not been replaced, the existing crush ring may be re-used. If you have replaced anyone of the above a shim kit must replace the crush ring. See Parts Information manual for number.

8 Place the bearing cup into trunnion cover over the crush ring or shims (see Figure 40).

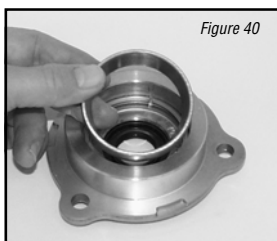
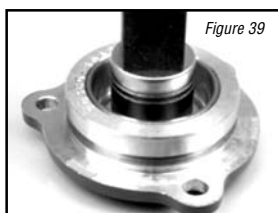

9 Lubricate and install the o-ring seal into counter-bore of housing (see Figure 41).

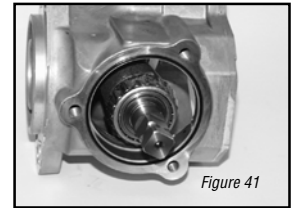

10 Install the trunnion cover over the control shaft and into the pump housing. Install the three retaining cap screws and washers, torque screws to 39,3 Nm [29 ft-lb] (see Figure 42).

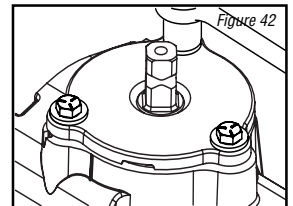

11 Using your fingers, tilt the camplate back and forth to check the trunnion bearing preload. Proper preload is achieved when the camplate has a very slight tilting resistance. The camplate must not have any or very little side clearance.

12 Reassemble the input shaft assembly by installing the thrust washer, thrust bearing, second thrust washer, retaining ring, washer and shaft seal (see Figure 43).



Note: The lip of the shaft seal must point toward the center of the input shaft.

13 Install the input shaft assembly into the housing assembly. Push the shaft seal in just far enough so you can start the shaft seal retaining ring.

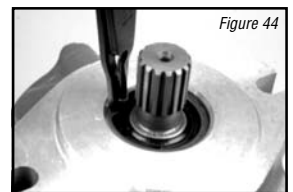

14 Use a pair of snap ring pliers to install retaining snap ring into the housing assembly (see Figure 44).

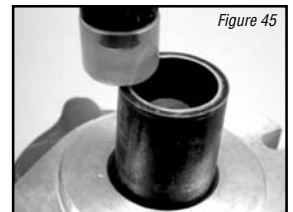

15 Use a seal driver or similar tool to press or drive the snap ring and seal into the housing assembly (see Figure 45).

CAUTION! Press or drive inward until the snap ring snaps into the snap ring groove located in the pump housing assembly.

16 The thrust plate is reversible. Either side will fit into the camplate. In most cases if any irregularities are noted it is best to replace the thrust plate (see Figure 46).

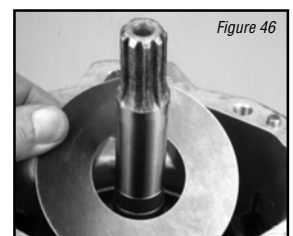

Repair Information - Reassembly

18 Lubricate and install the thrustplate over the input shaft assembly and into the camplate. The thrustplate must rest firmly in its pocket located in the camplate.

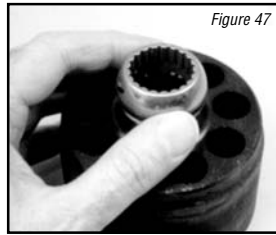

19 Reassemble the rotating kit assembly by first aligning the splines in the pivot with the splines in the block. Install the pivot on the block assembly pins (see Figure 47).

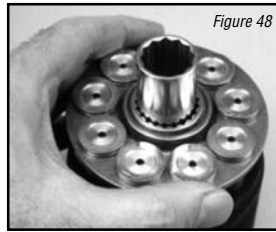

20 Use a small socket or similar tool to help retain the pivot in the centered position. Lubricate and install the spider and piston assemblies onto the pivot and pistons into the piston block assembly (see Figure 48).

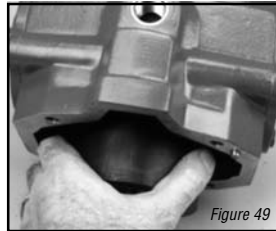

21 Hold the housing assembly in the vertical position then carefully install the rotating kit by first aligning with the splines on the input shaft. With splines aligned, install the rotating kit into the pump housing (see Figure 50). Use caution to ensure all parts are kept in their proper position.

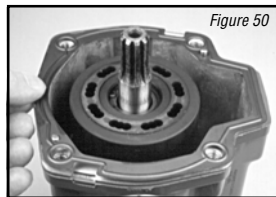

22 With the rotating kit installed, reposition the housing assembly in the input shaft down position and install a new housing gasket (see Figure 50).

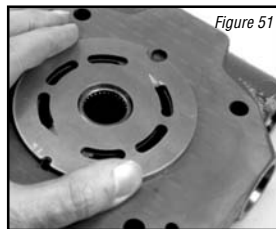

23 Lightly coat the backplate side of the valve plate with petroleum jelly for retention during assembly. Install the valve plate over the needle bearing, aligning the small slot on the outside of the valve plate with the dowel pin in the backplate (see Figure 51).

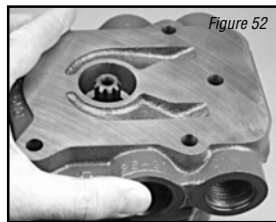

24 Carefully install the backplate assembly by aligning it with the dowel pins located in the pump housing. Use caution not to dislodge the valve plate (see Figure 54).

25 Align the spline of the gerotor's inner ring, then lubricate and install the inner ring and outer ring over the input shaft and onto the backplate assembly (see Figure 53).

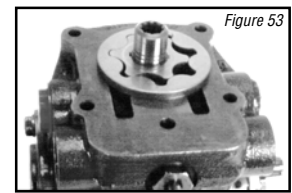

Note: Before installing the charge pump adaptor plate, offset the outer ring of the gerotor as shown.

26 With the gerotor assembly installed, install new o-ring into charge pump adapter plate and place adapter onto backplate over gerotor. Retain with cap screws. Torque cap screws to 25 N•m [18.5 lbf•ft] (see Figure 54).

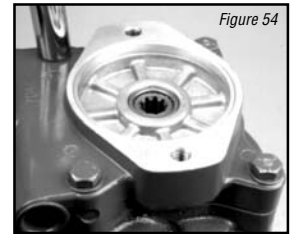

27 Install the two high pressure relief valves. Torque valves 128,8 to 142,4 Nm [95 to 105 lb-ft] (see Figure 55).

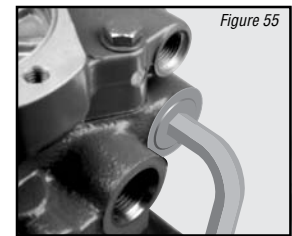

29 Lubricate and reassemble the bypass valve assembly. Install the bypass valve into the backplate. Torque valve to 30,5±2 Nm [22.5±1.5 lb-ft] (see Figure 56).

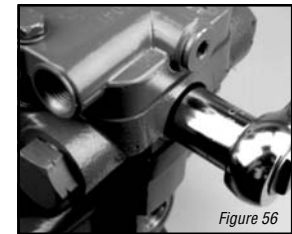

30 Coat the charge pressure poppet with petroleum jelly and place poppet onto spring and install into the adapter plate (see Figure 57).

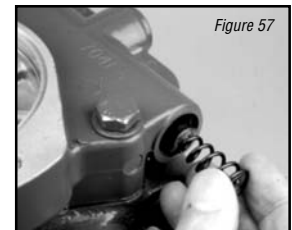

31 Install the hollow charge pressure relief valve retainer into the adapter plate. Torque retainer to 6,8 to 9,5 Nm [5 to 7 lb-ft].

32 Lubricate and install the o-ring on the cover plate or gear pump. Install the cover plate or gear pump and two cap screws. Torque cap screws to 36,6 to 40 Nm [27 to 31 lb-ft].

The Model 70160 or 78162 variable displacement pump is now ready for test and reinstallation.

Fault - Logic Troubleshooting

This fault - logic troubleshooting guide is a diagnostic aid in locating transmission problems.

Match the transmission symptoms with the problem statements and follow the action steps shown in the box diagrams. This will provide help in correcting minor problems eliminating unnecessary machine down time.

Following the fault - logic diagrams are diagram action comments of the action steps shown in the diagrams. Where applicable, the comment number of the statement appears in the action block of the diagrams.

Explanatory Diagram

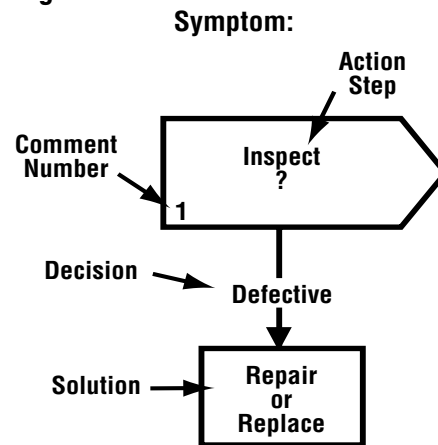

Recommended Gauge Locations

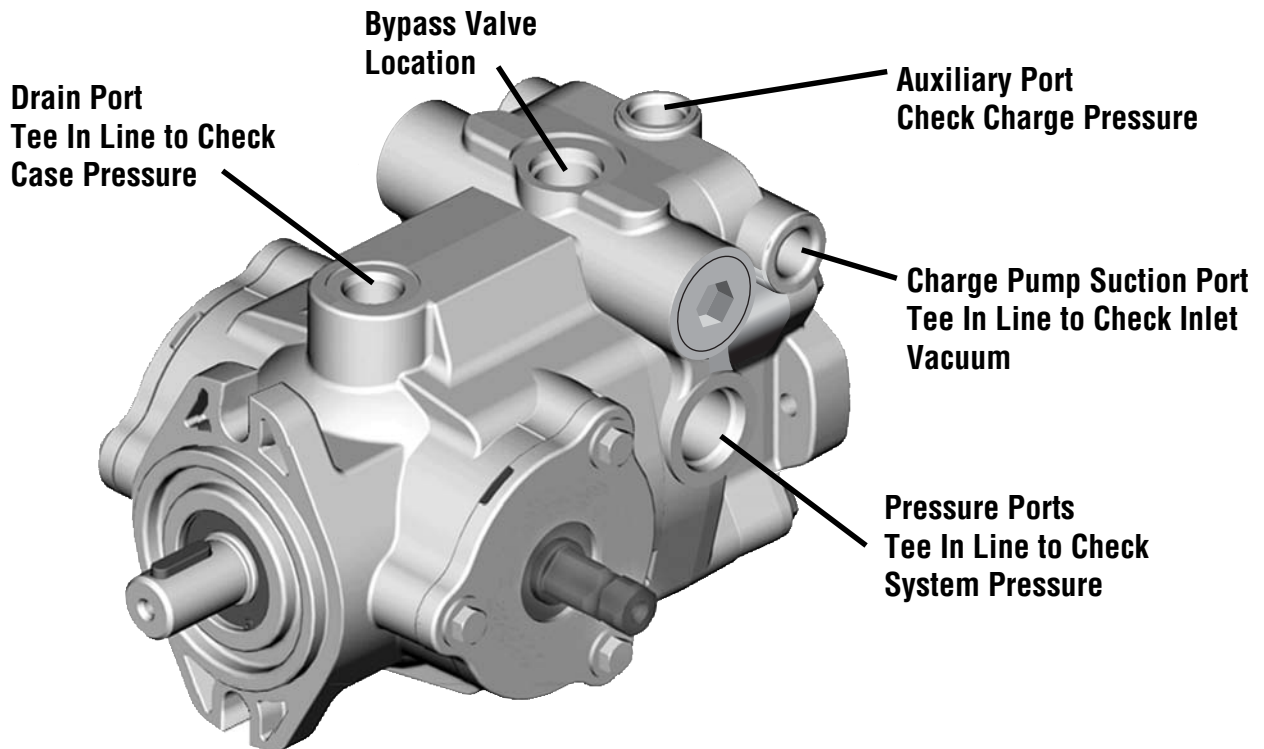

Figure 58

Gauges Recommended

- Inlet vacuum gauge: 2 bar to 1 bar [30 PSI to 30 inHg]
- System pressure gauge: 700 bar [10,000 PSI]
- Charge pressure gauge: 0 to 50 bar [0 to 600 PSI]
- Case pressure gauge: 0 to 25 bar [0 to 300 PSI]

Fault - Logic Troubleshooting

Symptom: Neutral Difficult or Impossible to Find

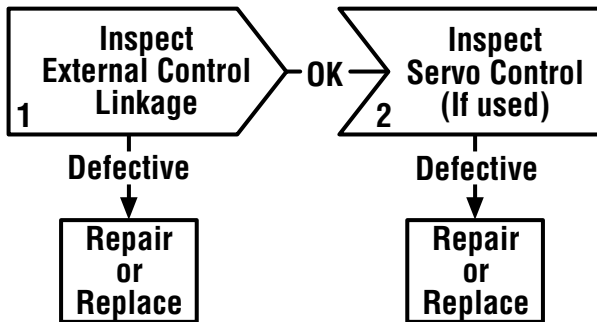

Symptom: System Operating Hot

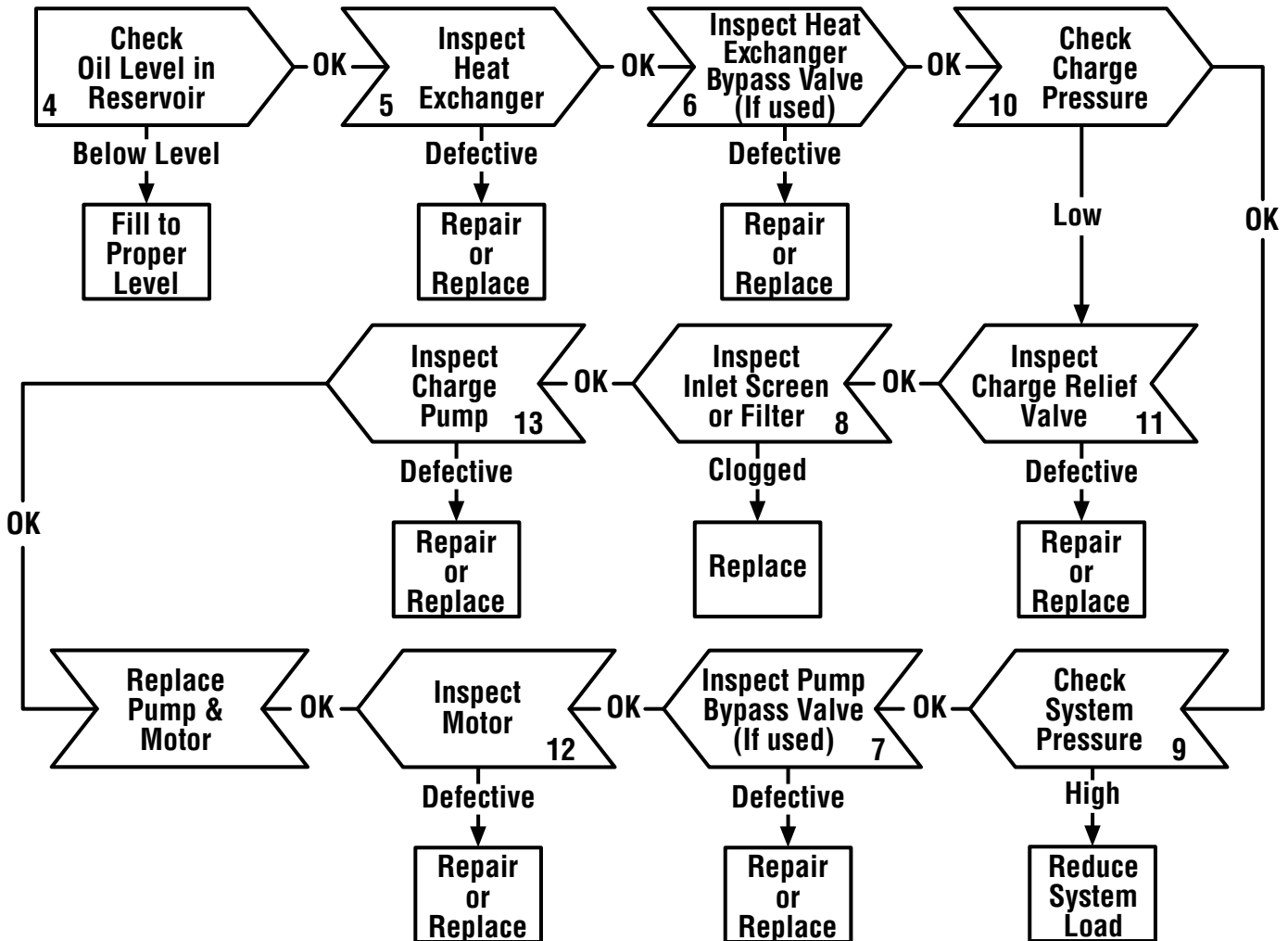

Fault - Logic Troubleshooting

Symptom: Operates in One Direction Only

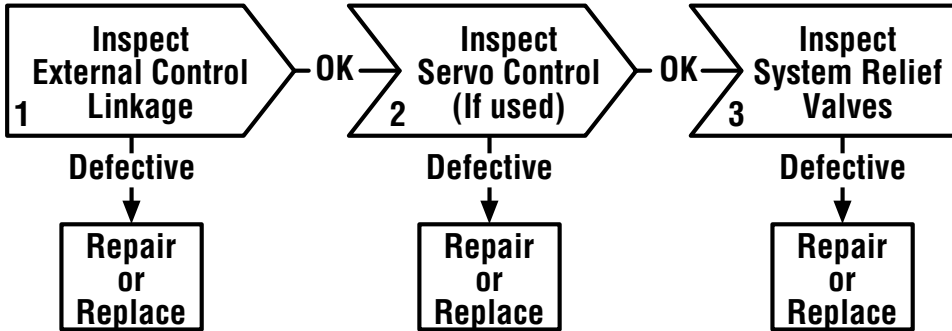

Symptom: System Response Sluggish

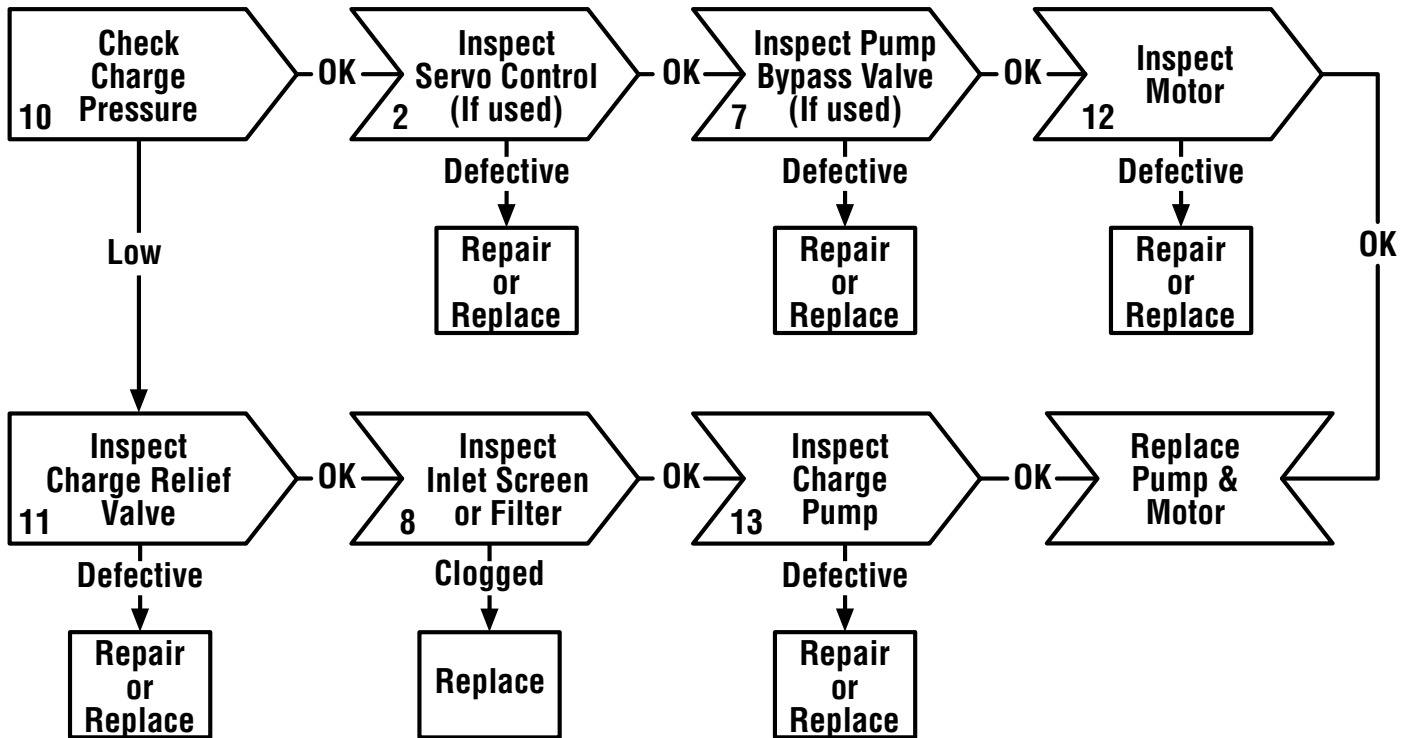

Fault - Logic Troubleshooting

Symptom: System Will Not Operate In Either Direction

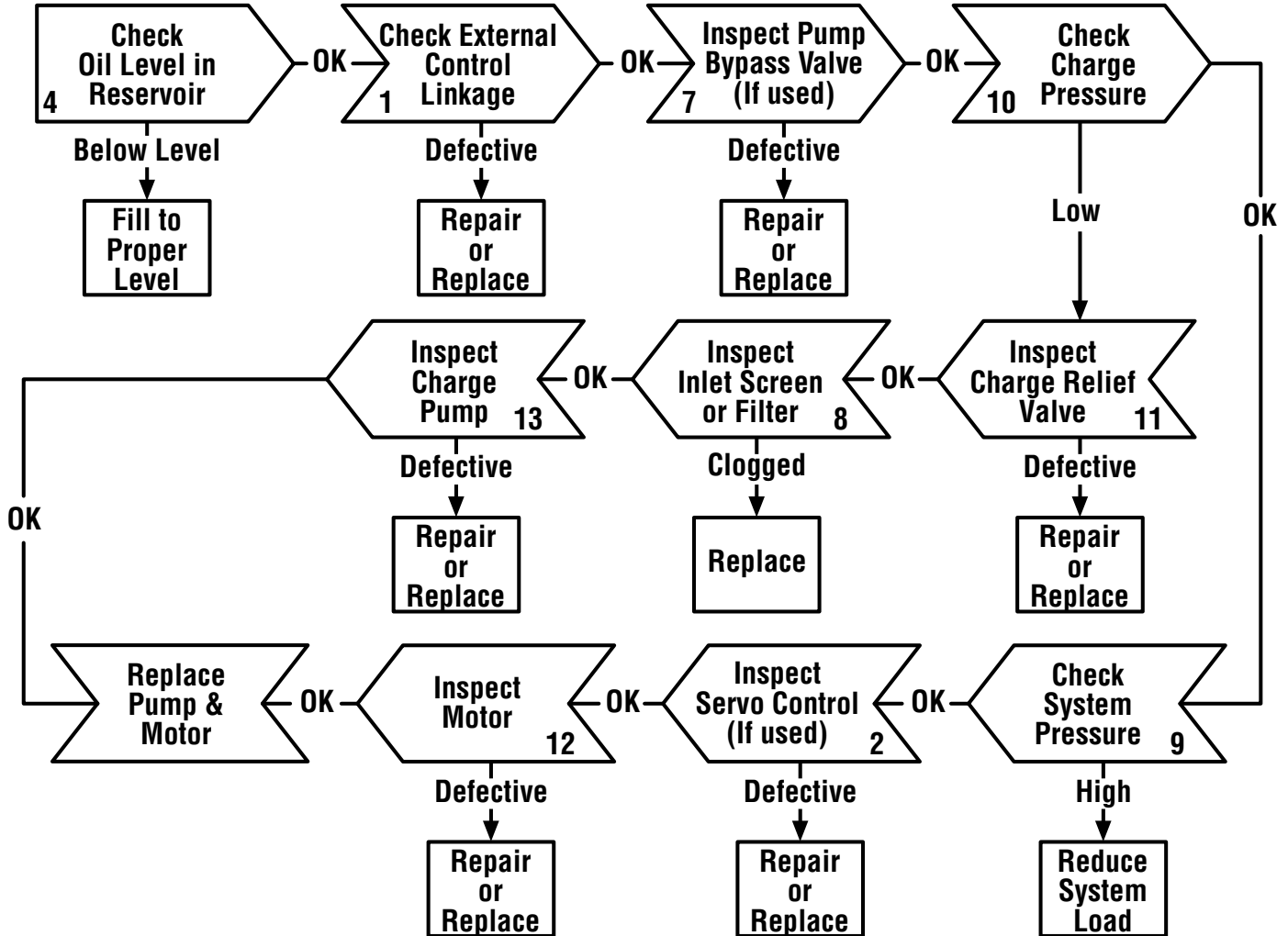

Fault - Logic Troubleshooting

Diagram Action Step Comments

- 1 Inspect External Control Linkage for:**
 - a. misadjustment or disconnection
 - b. binding, bending or breakage
 - c. misadjusted, damaged or broken neutral return spring
- 2 Inspect Servo Control Valve for: (if used)**
 - a. proper inlet pressure
 - b. misadjusted, damaged or broken neutral return spring
 - c. galled or stuck control spool
 - d. galled or stuck servo piston
- 3 Inspect System Relief Valves* for:**
 - a. improper pressure relief setting
 - b. damaged or broken spring
 - c. valve held off seat
 - d. damaged valve seat
- 4 Check Oil Level in Reservoir:**
 - a. consult owner/operators manual for the proper type fluid and level
- 5 Inspect Heat Exchanger for:**
 - a. obstructed air flow (air cooled)
 - b. obstructed water flow (water cooled)
 - c. improper plumbing (inlet to outlet)
 - d. obstructed fluid flow
- 6 Inspect Heat Exchanger Bypass Valve for: (if used)**
 - a. improper pressure adjustment
 - b. stuck or broken valve
- 7 Inspect Pump Bypass Valve for: (if used)**
 - a. held in a partial or full open position
- 8 Inspect Inlet Screen or Filter for:**
 - a. plugged or clogged screen or filter element
 - b. obstructed inlet or outlet
 - c. open inlet to charge pump
- 9 Check System Pressure:**
 - a. See figure 60 for location of pressure gauge installation.
 - b. consult owner/operators manual for maximum system relief valve settings
- 10 Check Charge Pressure:**
 - a. See figure 60 for location of pressure gauge installation.
 - b. consult owner/operators manual for maximum charge relief valve settings

- 11 Inspect Charge Relief Valve for:**
 - a. improper charge relief pressure setting *
 - b. damaged or broken spring
 - c. poppet valve held off seat
- 12 Inspect Motor for:**
 - a. disconnected coupling
- 13 Inspect Charge Pump for:**
 - a. broken or missing drive key
 - b. damaged or missing o-ring
 - c. excessive gerotor clearance
 - d. galled or broken gerotor set

*** System/Charge Relief Valve Pressure Settings for Eaton's Variable Displacement Controlled Piston Pumps**

Inlet Vacuum	6 inHg max.
Case Pressure	25 PSI maximum
Charge Pressure	100 to 150 PSI Standard 200 to 250 PSI Optional 250 to 300 PSI Optional
System Pressure	5000 PSI maximum 3000 PSI continuous

The high pressure relief valves are all factory preset and cannot be readjusted.

The pressure setting and assembly number is stamped on each high pressure relief valve cartridge.

Valve Identification Example:

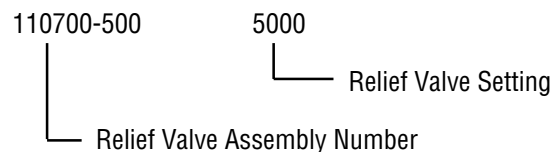

Start-up Procedure

When starting a new or rebuilt transmission system, it is extremely important to follow the start-up procedure. It prevents the chance of damaging the unit which might occur if the system was not properly purged of air before start-up.

- 1** After the transmission components have been properly installed, fill the pump housing at least half full with filtered system oil. Connect all hydraulic lines and check to be sure they are tight.
- 2** Install and adjust all control linkage.
- 3** Fill the reservoir with an approved oil that has been filtered through a 10 micron filter. Refer to Eaton Hydraulics Technical Data Sheet number 3-401 titled [Hydraulic Fluid Recommendations](#).
- 4** For Gasoline engines or L.P. engines remove the coil wire and turn the engine over for 15 seconds. For Diesel engines shut off the fuel flow to the injectors and turn the engine over for 15 seconds.
- 5** Replace the coil wire or return the fuel flow to the injectors. Place the transmission unit in the neutral position, start the engine and run it at a low idle. The charge pump should immediately pick up oil and fill the system. If there is no indication of fill in 30 seconds, stop the engine and determine the cause.

- 6** After the system starts to show signs of fill, slowly move pump camplate to a slight cam angle. Continue to operate system slowly with no load on motors until system responds fully.
- 7** Check fluid level in the reservoir and refill if necessary to the proper level with an approved filtered oil.
- 8** Check all line connections for leaks and tighten if necessary.

The machine is now ready to be put into operation.

Frequent filter changes are recommended for the first two changes after placing the machine back into operation. Change the first filter in 3-5 hours and the second in approximately 50 hours. Routinely scheduled filter changes are recommended for maximum life of the hydraulic system.

Notes: _____

Eaton
14615 Lone Oak Road
Eden Prairie, MN 55344
USA
Tel: 952 937-9800
Fax: 952 974-7722
www.hydraulics.eaton.com

Eaton
20 Rosamond Road
Footscray
Victoria 3011
Australia
Tel: (61) 3 9319 8222
Fax: (61) 3 9318 5714

Eaton
Dr.-Reckeweg-Str. 1
D-76532 Baden-Baden
Germany
Tel: (49) 7221 682-0
Fax: (49) 7221 682-788



Hydraulics

© 2004 Eaton Corporation
All Rights Reserved
Printed in USA
Document No. E-PUPI-TS005-E
June 2004