

OSPB, OSPC, OSPF,  
OSPD, OSPQ, OSPL

Load sensing

Steering units

OLS Priority valves

OSQ Flow amplifiers

Technical  
Information

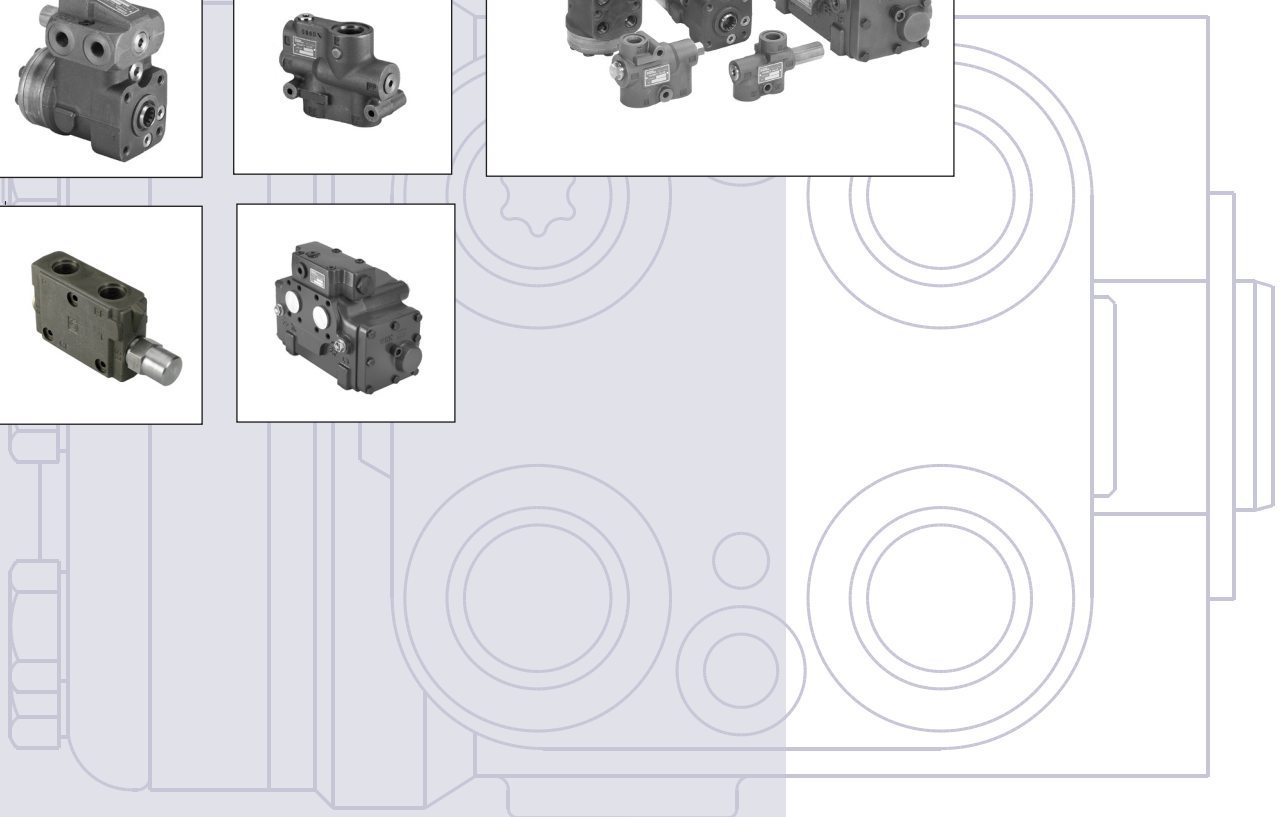
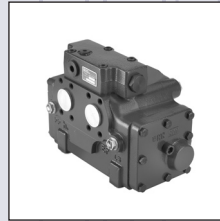

**A WIDE RANGE OF  
STEERING COMPONENTS**

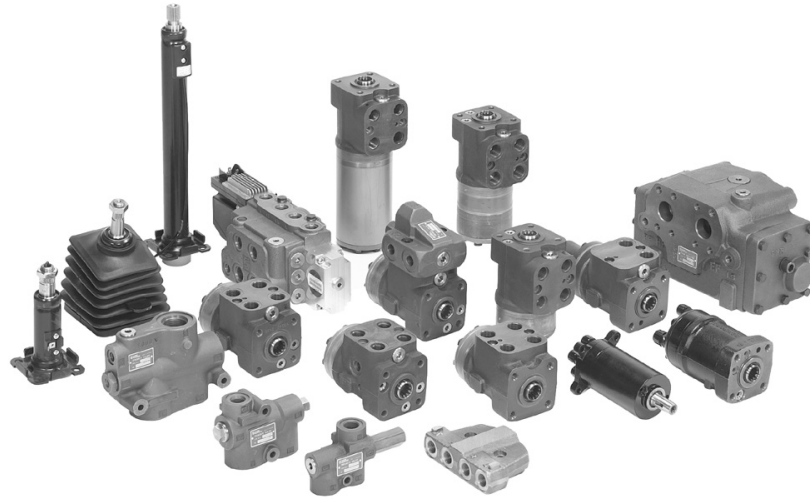

F300599

Sauer-Danfoss is the largest producer in the world of steering components for hydrostatic steering systems on off-road vehicles. Sauer-Danfoss offers steering solutions both at component and system levels. Our product range makes it possible to cover applications of all types - ranging from ordinary 2-wheel steering (also known as Ackermann steering) to articulated steering, complicated 4-wheel steering, automatic steering (e.g. by sensor) and remote controlled steering via satellite. We can offer more than 1000 different steering units, 150 different priority valves and 300 different steering columns categorised in types, variants and sizes.

**For hydrostatic steering systems Sauer-Danfoss offers:**

- Mini steering units with displacements from 32 to 100 cm<sup>3</sup>/rev [1.95 to 6.10 in<sup>3</sup>/rev], flow up to 20 l/min [5.28 US gal/min], steering pressure up to 125 bar [1813 psi].
- Steering units with displacements from 40 to 1200 cm<sup>3</sup>/rev [2.44 to 73.2 in<sup>3</sup>/rev], flow up to 100 l/min [26.4 US gal/min], steering pressure up to 240 bar [3481 psi].
- Priority valves for rated flows at 40, 80, 120, 160 and 320 l/min [10.6, 21.1, 31.7, 42.3 and 84.5 US gal/min], pressure up to 350 bar [5076 psi].
- Pilot operated flow-amplifiers with amplification factors of 4, 5, 8, 10 or 20 for rated oil flows of 240 and 400 l/min [63.4 and 105.7 US gal/min], steering pressure up to 210 bar [3045 psi].
- Pilot operated steering valve with steering flow up to 100 l/min [26.4 US gal/min], steering pressure up to 250 bar [3625 psi] and with integrated priority valve for pump flow up to 120 l/min [31.7 US gal/min].

© 2006 Sauer-Danfoss. All rights reserved. Printed in Europe  
Sauer-Danfoss accepts no responsibility for possible errors in catalogs, brochures and other printed material. Sauer-Danfoss reserves the right to alter its products without prior notice. This also applies to products already ordered provided that such alterations aren't in conflict with agreed specifications. All trademarks in this material are properties of their respective owners. Sauer-Danfoss and the Sauer-Danfoss logotype are trademarks of the Sauer-Danfoss Group.

Frontpage: F300611.TIF, F300612.TIF, F300615.TIF, F300617.TIF, F300620.TIF, F300622.TIF, F301256.TIF, F301470.TIF, F300601.TIF, Drawing 151-577 fa.eps

**A WIDE RANGE OF  
 STEERING COMPONENTS  
 (CONTINUED)**

**For electro-hydraulic steering systems Sauer-Danfoss offers:**

- Pilot operated steering valve (pilot operated by hydrostatic steering unit or by electrical signal) with steering flow up to 100 l/min [26.4 US gal/min], steering pressure up to 250 bar [3625 psi] and with integrated priority valve for pump flow up to 120 l/min [31.7 US gal/min]

**For hydromechanical steering systems Sauer-Danfoss offers:**

- Torque amplifiers for output torques of 80 and 120 N•m [708 and 1062 lbf•in]

**For steering units and torque amplifiers Sauer-Danfoss offers:**

- Steering columns: fixed, tiltable and/or telescopic with or without horn switch and sensor for start/stop of pump, with length, from 45 to 1200 mm [1.77 to 47.2 in]

**Characteristic features of steering units:**

- Low steering torque: From 0.5 N•m to 3 Nm [4.42 to 26.6 lbf•in] in normal steering situations
- Low noise level
- Low pressure drop
- Many types available: Open center Non reaction, Open center Reaction, Closed center Non reaction, Load Sensing, Load Sensing Reaction, Power Beyond
- One or more built-in valve functions: relief valve, shock and suction valves in L- and R-line, non return valve in P-line and in LS-line
- Optional port connections (according to ISO, SAE or DIN standards)

**Characteristic features of electro-hydraulic steering system:**

- High steering pressure requiring smaller cylinders and flow
- Low noise emission in the cab because of low pilot pressure
- The possibility of emergency steering even on very heavy vehicles
- Minimization of side acceleration with articulated steering
- With microcontroller: No steering wheel drift and the possibility of variable steering ratio
- Analogue and CAN-bus interface
- Electro-hydraulic steering valve EHPS can be combined with Sauer-Danfoss PVG 32 proportional valve
- The system is approved by TÜV and have a controller with safety critical steering software

**CONVERSION FACTORS**

1 Nm = 8.851 lbf•in  
 1 N = 0.225 lbf  
 1 bar = 14.50 psi  
 1 mm = 0.0394 in

1 cm<sup>3</sup> = 0.061 in<sup>3</sup>  
 1 litre = 0.264 US gal  
 °F = 1.8 × °C + 32

**CONTENTS**

<b>A wide range of steering components.....</b>	<b>2</b>
Conversion factors.....	3
<b>Survey of literature with technical data on Sauer-Danfoss steering componenets.....</b>	<b>6</b>
<b>Steering units OSPB, OSPC, OSPF, OSPD, OSPQ, OSPL Load Sensing .....</b>	<b>7</b>
Versions .....	7
Code numbers and weights.....	13
OSPB LS.....	13
OSPC LS.....	15
OSPC LSR.....	17
OSPF LS .....	18
OSPD LS .....	19
OSPQ LS .....	20
OSPL LS .....	21
OSPBX LS, OSPLX LS, OSPCX LS .....	23
Specification table for non catalogue numbers of LS steering units.....	24
Port thread versions and valve combinations.....	26
Technical data .....	29
Displacement, flow and pressure: OSPB LS, OSPC LS, OSPC LSR.....	29
Displacement, flow and pressure: OSPF LS .....	30
Displacement, flow and pressure: OSPD LS, OSPQ LS .....	31
Displacement, flow and pressure: OSPL LS, OSPBX LS, OSPCX LS, OSPLX LS .....	32
Valve functions in OSPC, OSPF, OSPD, OSPQ and OSPL LS steering units .....	33
Port thread versions.....	35
Dimensions .....	36
OSPB LS, OSPBX LS.....	36
OSPC LS/LSR, OSPF LS, OSPCX LS.....	37
OSPD LS/LSR .....	38
OSPQ LS/LSR .....	39
OSPL LS, OSPLX LS .....	40
<b>Priority valves OLSA and OLS .....</b>	<b>42</b>
Versions .....	42
System sizing.....	45
Code numbers and weights.....	45
OLS/OLSA static priority valves for LS static steering units .....	45
OLS/OLSA dynamic priority valves for LS dynamic steering units .....	47
OLS dynamic priority valves for OSPF LS dynamic steering units .....	48
OLSP 80 priority valves for flanging on pumps.....	48
OLS320 priority valves.....	49
Specification table for non catalogue numbers of Sauer-Danfoss priority valves .....	50
Technical data .....	51
Max. pressure on connections.....	51
Pressure drop in priority valves.....	52
OLS 160 + OLS 320, pilot pressure relief valve.....	58
Dimensions .....	59
OLSA .....	59
OLS 40, OLS 80.....	60
OLS 120.....	61
OLS 160.....	62
OLSP 80 .....	63
OLS 320 .....	64

**CONTENS**

<b>Flow amplifiers OSQA, OSQB and OSQB/OLSQ .....</b>	<b>65</b>
Versions .....	65
Code numbers and weights.....	67
Specification table for non catalogue numbers of Sauer-Danfoss flow amplifiers .....	68
Technical data .....	69
Flow and pressure.....	69
Total displacement of steering system .....	69
Installation .....	69
Valve functions in the flow amplifiers.....	70
Dimensions .....	74
OSQA .....	74
OSQB.....	75
OSQB/OLSQ.....	76

**SURVEY OF LITERATURE  
 WITH TECHNICAL DATA  
 ON SAUER-DANFOSS  
 STEERING  
 COMPONENTS**

Detailed data on all Sauer-Danfoss steering components and accessories can be found in our steering component catalogues, which is divided in 6 individual subcatalogues:

- General information Steering components
  
- Technical data on mini steering units and steering columns for mini steering units: OSPM and OTPM
  
- Technical data on open center and closed center steering units and on torque amplifiers: OSPB, OSPC, OSPR, OSPD and TAD
  
- Technical data on load sensing steering units, priority valves and flow-amplifiers: OSPB, OSPC, OSPF, OSPD, OSPQ, OSPL, OSPBX, OSPCX, OSPLX, OLS and OSQ
  
- Technical data on hydraulic and electro-hydraulic pilot operated steering valve, appropriate steering units and electrical actuation module for electro-hydraulic steering systems EHPS and OSPCX  
PVE and PVED for EHPS
  
- Technical data on valve blocks and steering columns OTPB, SASA, OVPL and OVR

The most important data on all Sauer-Danfoss steering components is highlighted in a general survey brochure.

For technical information on individual variants, please contact the Sauer-Danfoss Sales Organization

**VERSIONS**

*Load sensing*

In load sensing steering systems both the steering system and the working hydraulics can be supplied with oil from the same pump, using a load sensing pump, also delivers the potential for energy saving.

Load sensing steering units have an extra connection for load sensing (LS), so that a load pressure signal can be directed via the steering unit to a Sauer-Danfoss priority valve and/or an LS pump. The load sensing signal controls the oil flow from the priority valve (and/or the LS pump) to the steering unit. The LS connection is open to tank when the steering unit is in the neutral position.

*Load sensing static*

Load sensing static steering units require load sensing static priority valves and/or load sensing static variable displacement pumps. Load sensing static steering systems have no oil flow in the LS connection when the steering unit is in neutral position.

*Load sensing dynamic*

Load sensing dynamic steering units require load sensing dynamic priority valves and/or load sensing dynamic variable displacement pumps. Load sensing dynamic steering systems have a constant oil flow in the LS connection in the direction of the steering unit even when the steering unit is in neutral position.

*Reaction*

With reaction steering units any external forces acting on the steered wheels result in a corresponding movement of the steering wheel when the driver is not steering the vehicle.

*Non-reaction*

With non-reaction steering units there is no corresponding movement of the steering wheel when the driver is not steering the vehicle

**OSPB LS: Steering unit with no valve functions**

Sauer-Danfoss diagram

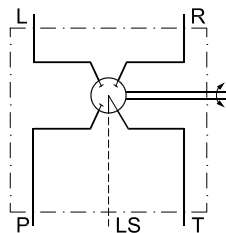

CETOP diagram

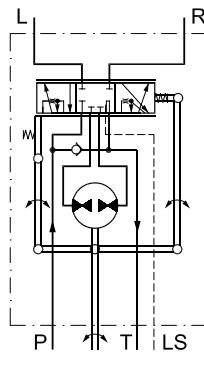

OSPB LS (OLS)

*Load sensing static non-reaction and load sensing dynamic non-reaction*



F300614

**VERSIONS**



F300614



F300724

**OSPC LS: Steering unit load sensing with integrated valve functions for in line priority valve OLS**

**OSPC LS: Steering unit load sensing with integrated valve functions for flange on priority valve OLSA**

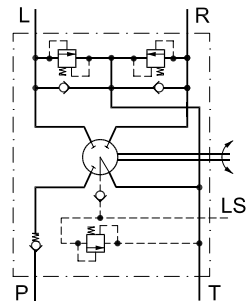

150-595.11

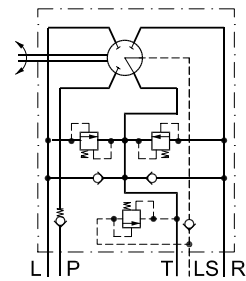

150-596.10

*OSPC LS (OLS)  
 Load sensing dynamic non-reaction*

*OSPC LS (OLSA)  
 Load sensing dynamic non-reaction*



**VERSIONS**



F300617

**OSPC LSR: Steering unit load sensing dynamic with integrated valve functions**

**OSPF LS : Steering unit full drain load sensing dynamic and with integrated valve functions**

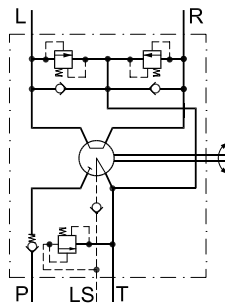

150-598.11

*OSPC LSR (OLS)  
 Load sensing dynamic reaction*

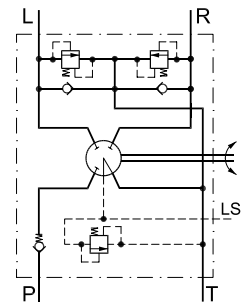

150-597.11

*OSPF LS (OLS)  
 Load sensing dynamic non-reaction*

**VERSION**

**OSPD LS: Steering unit load sensing dynamic with 2 rotary meters and with integrated valve functions**

The OSPD has 2 rotary meters (gear wheel sets). Should the pump supply be lost, only one rotary meter is active for emergency steering. In normal steering situations both rotary meters are active.

**OSPQ LS: Steering unit load sensing dynamic with flow amplification and with integrated valve functions**

The OSPQ has incorporated amplification valve. Should pump supply fail or the steering wheel speed be less than approximate 10 rev/min only the rotary meter determines the displacement. In normal steering situations or at higher steering wheel speed, oil is also led to the steering cylinder via the built in amplification valve.



F300612

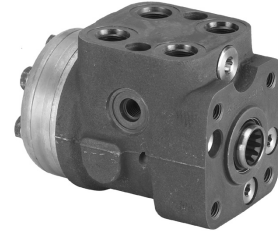

F300615

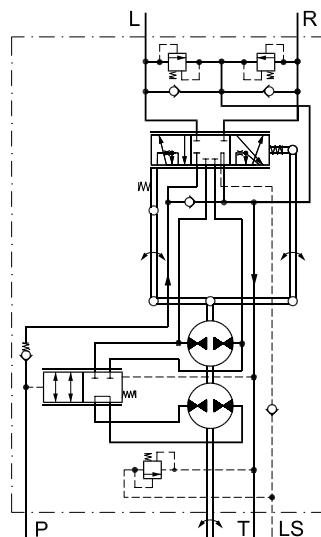
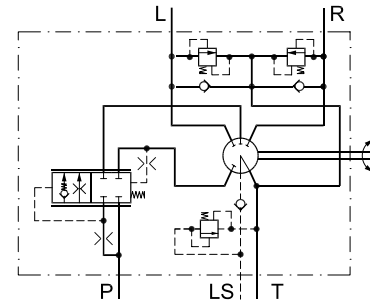
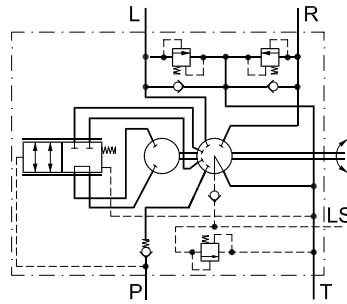

150-599.11

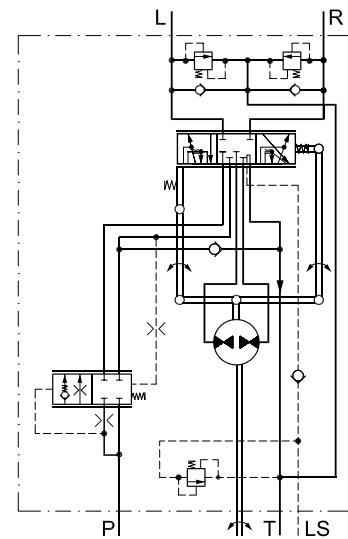

*OSPD LS (OLS)  
 Load sensing dynamic non-reaction*

*OSPQ LS (OLS)  
 Load sensing dynamic non-reaction*

**VERSION**

**OSPL LS: Steering unit load sensing for high steering flow, displacement larger than 500 cm<sup>3</sup>/rev [30.5 in<sup>3</sup>/rev].**



*OSPL LS (OLS)  
 Load sensing static non-  
 reaction*

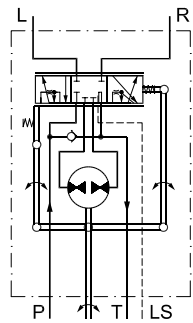
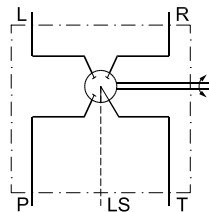

150-301.11

*OSPL LS (OLS)  
 Load sensing dynamic*

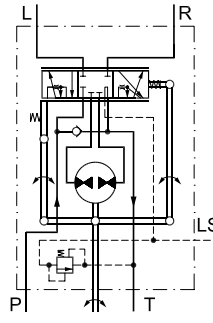
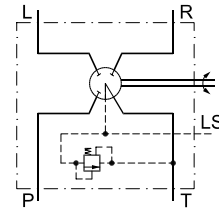

150-601.10

F300611

*OSPL 1200 (OLS) Load sens-  
 ing dynamic non-reaction*

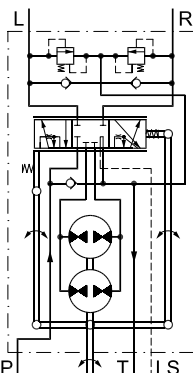
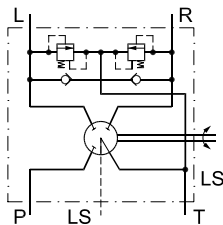

150-613.10



F301082

**VERSIONS**

**OSPBX LS, OSPCX LS and OSPLX LS: Steering units load sensing for flow amplifiers.**

OSPBX LS, OSPCX LS and OSPX LS are load sensing steering units with the L and the R connections open to tank when in neutral position. OSPBX LS, OSPCX LS and OSPX LS can only be used with Sauer-Danfoss flow-amplifiers OSQA or OSQB. OSPBX LS, OSPCX LS and OSPX LS steering units must not be connected directly to the steering cylinder. OSPCX LS is for OSQ dynamic without pilot pressure relief valve.



F300614

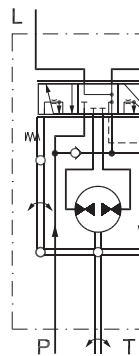
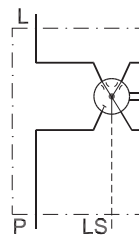

OSPBX LS, OSPLX LS  
 Load sensing static

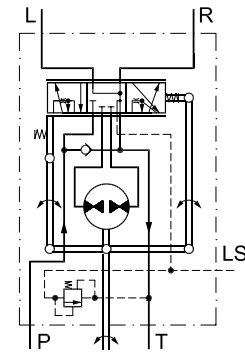
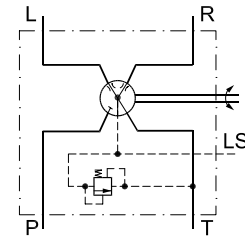

OSPCX LS  
 Load sensing dynamic

**CODE NUMBERS AND WEIGHTS**

**OSPB load sensing static non-reaction steering units**

OSPB LS Static steering units have no valve functions.

OSPB LS in the table below have all standard neutral setting springs, see page 24

Steering unit	Code Numbers Connections		Weight  kg [lb]
	European version for OLS G 1/2 G 1/4 - S**	US version for OLS 3/4-16 UNF - O* 7/16-20 UNF - O* + S**	
OSPB 50 LS	-	150G6085	5.2 [11.46]
OSPB 80 LS	-	150G6086	5.3 [11.68]
OSPB 100 LS	-	150G6087	5.4 [11.90]
OSPB 125 LS	-	150G6088	5.5 [12.13]
OSPB 160 LS	-	150G6089	5.6 [12.35]
OSPB 200 LS	150-0103	150G6090	5.8 [12.79]
OSPC 315 LS	150-0104	150-0116	6.2 [13.67]
OSPB 400 LS	150-0105	150-0117	7.0 [15.43]

O\*: O-ring chamfer on port connections

S\*\*: Spot face around port connection

Valve blocks OVP and OVR can be mounted on all of the OSPB steering units from the above table.

**CODE NUMBERS AND WEIGHTS**

**OSPB Load sensing dynamic non-reaction steering units**

OSPB LS Dynamic steering units have no valve functions.

OSPB LS in the table below have all standard neutral setting springs, see page 24

Steering unit	Code Numbers	Weight kg [lb]
	Connections US version for OLS  3/4-16 UNF - O* 7/16-20 UNF - O* + S**	
OSPB 50 LS	150-8204	5.2 [11.46]
OSPB 80 LS	150-8205	5.3 [11.68]
OSPB 100 LS	150-8206	5.4 [11.90]
OSPB 125 LS	150-8207	5.5 [12.13]
OSPB 160 LS	150-8208	5.6 [12.35]
OSPB 200 LS	150-8209	5.8 [12.79]
OSPB 315 LS	150-8210	6.2 [13.67]
OSPB 400 LS	150-8211	7.0 [15.43]

O\*: O-ring chamfer on port connections

S\*\*: Spot face around port connection

Valve blocks OVP and OVR can be mounted on all of the OSPB steering units from the above table

**CODE NUMBERS AND WEIGHTS**

**OSPC load sensing static non-reaction steering unit**

OSPC LS Static steering units in the table below incorporate all the following valve functions:

- check valve in P-port
- pilot pressure relief valve
- shock valves
- suction valves

OSPC LS in the table below have all standard neutral setting springs, see page 24

Steering unit	Code Numbers			Valve settings		Weight kg [lb]
	Connections			Relief valve bar [psi]	Shock valve bar [psi]	
	European for OLS G ½ G ¼ - S**	European and US version for OLSA	US version for OLS ¾-16 UNF - O* 7/16-20 UNF - O* + S**			
OSPC 80 LS	150-1230	150-1188	150-1222	170 [2465]	225 [3263]	5.3 [11.68]
OSPC 100 LS	150-1231	150-1189	150-1221			5.4 [11.90]
OSPC 125 LS	150-1232	150-1190	150-1220			5.5 [12.13]
OSPC 160 LS	150-1233	150-1191	150-1219			5.6 [12.35]
OSPC 200 LS	150-1234	150-1192	150-1218			5.8 [12.79]
OSPC 315 LS	150-1235	-	150G6091			6.2 [13.67]
OSPC 400 LS	150-1240	-	-			7.0 [15.43]

O\*: O-ring chamfer on port connections

S\*\*: Spot face around port connections

---

If you require other port connections, valve combinations and/or other valve settings or other displacements, please fill in the order form on page 24 and contact the Sauer-Danfoss Sales Organization.

---

**CODE NUMBERS AND WEIGHTS**

**OSPC load sensing dynamic non-reaction steering units**

OSPC LS Dynamic steering units in the table below incorporate all the following valve functions:

- check valve in P-port
  - pilot pressure relief valve
  - shock valves
  - suction valves
  - check valve in LS-line for all OSPC LS Dynamic up to and including 200 cm<sup>3</sup>/rev
- OSPC LS in the table below have all standard neutral setting springs, see page 24

Steering unit	Code Numbers			Valve settings		Weight kg [lb]
	European version for OLS G 1/2 - S** G 1/4 - S**	European and US version for OLSA	US version for OLS 3/4-16 UNF - O* 7/16-20 UNF - O* + S**	Relief valve bar [psi]	Shock valve bar [psi]	
OSPC 50 LS	150-8233	150-8222	150-8215	140 [2030]	200 [2900]	5.2 [11.46]
OSPC 80 LS	150-8234	150-8223	150-8216	170 [2465]	225 [3263]	5.3 [11.68]
OSPC 100 LS	150-8235	150-8224	150-8217			5.4 [11.90]
OSPC 125 LS	150-8236	150-8225	150-8218			5.5 [12.13]
OSPC 160 LS	150-8237	150-8226	150-8219			5.6 [12.35]
OSPC 200 LS	150-8238	150-8227	150-8220			5.8 [12.79]
OSPC 315 LS	150-8239	-	150-8221			6.2 [13.67]
OSPC 400 LS	150-8240	-	-			7.0 [15.43]

O\*: O-ring chamfer on port connections

S\*\*: Spot face around port connections

---

If you require other port connections, valve combinations and/or other valve settings or other displacements please fill in the order form on page 24 and contact the Sauer-Danfoss Sales Organization.

---



**CODE NUMBERS AND WEIGHTS**

**OSPC load sensing dynamic reaction steering units**

OSPC LSR Dynamic steering units in the table below incorporate all the following valve functions:

- check valve in P-port
- pilot pressure relief valve
- shock valves
- suction valves
- check valve in LS-line

OSPC LSR in the table below have all standard neutral setting springs, see page 24

Steering unit	Code Numbers	Valve settings		Weight
	Connections	Relief valve	Shock valve	
	European version for OLS G 1/2 - S** G 1/4 - S**			
OSPC 80 LSR	150-8241	170 [2465]	225 [3263]	5.3 [11.68]
OSPC 200 LSR	150-8242			5.8 [12.79]

O\*: O-ring chamfer on port connections

S\*\*: Spot face around port connections (can not be used in connection with OVR angular block)

---

If you require other port connections, valve combinations, valve settings and/or other displacements, please fill in the order form on page 24 and contact the Sauer-Danfoss Sales Organization.

---

**CODE NUMBERS AND WEIGHTS**

**OSPF load sensing dynamic non-reaction steering units**

OSPF LS Dynamic steering units in the table below incorporate all the following valve functions:

- check valve in P-port
- pilot pressure relief valve
- shock valves
- suction valves

OSPF LS in the table below have all soft neutral setting springs, see page 24

Steering unit	Code Numbers	Valve settings		Weight kg [lb]
	Connections European version for OLS G 1/2 - S** G 1/4 - S**	Relief valve bar [psi]	Shock valve bar [psi]	
OSPF 80 LS	150G5079	170 [2465]	225 [3263]	5.3 [11.68]
OSPF 100 LS	150G5080			5.4 [11.90]
OSPF 125 LS	150G5081			5.5 [12.13]
OSPF 160 LS	150G5082			5.6 [12.35]
OSPF 200 LS	150G5083			5.8 [12.79]
OSPF 315 LS	150G5084			6.2 [13.67]
OSPF 400 LS	150G5085			7.0 [15.43]

O\*: O-ring chamfer on port connections

S\*\*: Spot face around port connections (can not be used in connection with OVR angular block)

---

If you require other port connections, valve combinations, valve settings and/or other displacements, please fill in the order form on page 24 and contact the Sauer-Danfoss Sales Organization.

---

**CODE NUMBERS AND WEIGHTS**

**OSPD load sensing non-reaction steering units**

OSPD LS Dynamic steering units in the table below incorporate all the following valve functions:

- check valve in P-port
- pilot pressure relief valve
- shock valves
- suction valves
- check valve in LS-line

OSPD LS in the table below have all standard neutral setting springs, see page 24

Steering unit	Code Numbers	Valve settings		Weight
	Connections European version G ½ - S** G ¼ - S**	Relief valve  bar [psi]	Shock valve  bar [psi]	
OSPD 70/230 LS	150G8112	170 [2465]	225 [3263]	7.7 [17.00]
OSPD 70/270 LS	150G8113			7.9 [17.41]
OSPD 70/385 LS	150G8114			8.4 [18.52]
OSPD 125/325 LS	150G8128			8.1 [12.79]
OSPD 125/440 LS	150G8129			8.6 [18.96]

S\*\*: Spot face around port connections (can not be used in connection with OVR angular block)

---

If you require other port connections, valve combinations, valve settings and/or other displacements, please fill in the order form on page 24 and contact the Sauer-Danfoss Sales Organization.

---

**CODE NUMBERS AND WEIGHTS**

**OSPQ load sensing dynamic non-reaction steering units**

OSPQ LS Dynamic steering units in the table below incorporate all the following valve functions:

- check valve in amplification valve, act as check valve in P-port
- pilot pressure relief valve
- shock valves
- suction valves
- check valve in LS-line

OSPQ LS in the table below have all standard neutral setting springs, see page 24

Steering unit	Code Numbers	Valve settings		Weight kg [lb]
	Connections	Relief valve bar [psi]	Shock valve bar [psi]	
	European version M 18 x 1.5 - O* + S** M 12 x 1.5 - O* + S**			
OSPQ 80/125 LS	150G8012	170 [2465]	225 [3263]	5.3 [11.68]
OSPQ 125/250 LS	150G8011			5.5 [12.79]
OSPQ 160/320 LS	150G8030			5.6 [12.35]

O\*: O-ring chamfer on port connections

S\*\*: Spot face around port connections (can not be used in connection with OVR angular block)

---

If you require other valve combinations, valve settings and/or other displacements, please fill in the order form on page 24 and contact the Sauer-Danfoss Sales Organization.

---

**CODE NUMBERS AND WEIGHTS**

**OSPL load sensing static non-reaction steering units**

OSPL LS Static steering units have no valve functions.

OSPL LS in the three tables below have all strong neutral setting springs, see page 24

Steering unit	Code Numbers			Weight kg [lb]
	European version for OLS G 1/2 G 1/4 - S**	Connections		
		US version for OLS 3/4-16 UNF - O* 7/16-20 UNF - O* + S**	US version for OLS and OVPL LS - port 7/16-20 UNF - O* + S**	
OSPL 520 LS	150-7169	150-7167	150-7168	8.1 [17.86]
OSPL 630 LS	150-7107	150-7164	150-7113	8.4 [18.52]
OSPL 800 LS	150-7108	150-7165	150-7114	8.8 [19.40]
OSPL 1000 LS	150-7110	150-7166	150-7115	10.0 [22.05]

O\*: O-ring chamfer on port connections      S\*\*: Spot face around port connection

**OSPL load sensing dynamic non-reaction steering units**

OSPL LS Dynamic steering units in the table below have no valve functions.

Steering unit	Code Numbers		Weight kg [lb]
	Connections		
	US version for OLS 3/4-16 UNF - O*      7/16-20 UNF - O* + S**		
OSPL 520 LS	150-8243		8.1 [17.86]
OSPL 630 LS	150-8212		8.4 [18.52]
OSPL 800 LS	150-8213		8.8 [19.40]
OSPL 1000 LS	150-8214		10.0 [22.05]

O\*: O-ring chamfer on port connections      S\*\*: Spot face around port connection

OSPL LS Dynamic steering units in the table below incorporate all the following valve function:      • pilot pressure relief valve

Steering unit	Code Numbers	Valve settings	Weight kg [lb]
	Connections European version for OLS and OVPL LS: G 1/4 - S**		
OSPL 520 LS	150-8244	Relief valve bar [psi] 170 [2465]	8.1 [17.86]
OSPL 1000 LS	150-8245		10.0 [22.05]

S\*\*: Spot face around port connection

If you require other displacements or other valve setting, please fill in the order form on page 24 and contact the Sauer-Danfoss Sales Organization.

LS Steering units OSPB, OSPC, OSPF, OSPD, OSPQ, OSPL

OSPL 1200 LS Dynamic steering unit in the table below incorporate all the following valve function:

- shock valves
- suction valves

OSPL 1200 LS in the table below has strong neutral setting springs, see page 24

Priority valve	Code numbers	Valve settings		Weight	
	Connections	Shock valves		kg	[lb]
	US version for OLS <sup>3</sup> / <sub>16</sub> - 16 UNF - O* CF: 1 <sup>1</sup> / <sub>16</sub> -12 UN <sup>7</sup> / <sub>16</sub> - 20 UNF-O*+S**	bar	[psi]		
OSPL 1200 LS	150-7175	280	[4061]	11	[24.25]

O\*: O-ring chamfer on port connections

S\*\*: Spot face around port connection

---

If you require other displacements or other valve setting, please fill in the order form on page 24 and contact the Sauer-Danfoss Sales Organization.

---

**CODE NUMBERS AND WEIGHTS**

**OSPBX and OSPLX load sensing static steering units for OSQ static**

OSPBX LS and OSPLX LS Static steering units in the table below have no valve functions.  
 OSPBX LS in the table below have all standard neutral setting springs, see page 24  
 OSPLX LS in the table below have all strong neutral setting springs, see page 24

Steering unit	Code Numbers		Weight kg [lb]
	Connections		
	European version	US version	
	G 1/2 G 1/4 - S**	3/4-16 UNF - O* 7/16-20 UNF - O* + S**	
OSPBX 160 LS	150-1082	150-1078	5.6 [12.35]
OSPBX 200 LS	150-1083	150-1079	5.8 [12.79]
OSPBX 315 LS	150-1084	150-1080	6.2 [13.67]
OSPBX 400 LS	150-1085	150-1081	7.0 [15.43]
OSPLX 520 LS	150-7170	150-7173	8.1 [17.86]
OSPLX 630 LS	150-7171	150-7174	8.4 [18.52]
OSPLX 800 LS	150-7172	150-7155	8.8 [19.40]

O\*: O-ring chamfer on port connections  
 S\*\*: Spot face around port connection

**OSPCX load sensing dynamic steering units for OSQ dynamic**

OSPCX LS Dynamic steering unit in the table below incorporates the following valve function:

- pilot pressure relief valve

OSPCX LS in the table below has standard neutral setting springs, see page 24

Steering unit	Code Numbers		Valve settings Relief valve bar [psi]	Weight kg [lb]
	Connections			
	European version for OLS and OVPL G 1/2 - S**    G 1/4 - S**			
OSPCX 160 LS	150-8188		200 [2900]	5.6

S\*\*: Spot face around port connection

If you require other displacements or other valve setting, please fill in the order form on page 24 and contact the Sauer-Danfoss Sales Organization.

**SPECIFICATION TABLE  
 FOR NON CATALOGUE  
 NUMBERS OF  
 LS STEERING UNITS**

Fill in your company data and place x's in the table where appropriate, then send to your Sauer-Danfoss Sales Organisation.

Your company	Name		Vehicle			Potential pcs/year				Completed by			Date	
Steering unit type	OSPC		OSPF		OSPD		OSPQ		OSPL		OSPLX		OSPCX	
Reaction type	LS ( Non-reaction)						LSR (Reaction: only OSPC, OSPF, OSPD, OSPQ)							
Load Sensing type	Static (Only OSPC, OSPL, OSPLX, OSPCX)						Dynamic							
DP, cm <sup>3</sup> /rev OSPC LS OSPF LS	40	50	60	70	80	100	125	160	185	200	230	250	315	400
DP, cm <sup>3</sup> /rev OSPC LSR	40		50		60		70		80		100		200	
DP, cm <sup>3</sup> /rev OSPD LS	60/185	60/220	60/260	70/195	70/230	70/270	70/385	100/200	100/260	100/300	125/285	125/325	125/440	
DP, cm <sup>3</sup> /rev OSPD LSR	60/185		60/220		70/195		70/230		100/200					
DP, cm <sup>3</sup> /rev OSPQ LS	80/125	80/140	80/160	100/160	100/180	100/200	125/200	125/250	160/250	160/320				
DP, cm <sup>3</sup> /rev OSPQ LSR	80/125		80/140		80/160		100/160		100/180		100/200		125/200	
DP, cm <sup>3</sup> /rev OSPL, OSPLX	520			630			800			1000		1200 (only OSPL)		
DP, cm <sup>3</sup> /rev OSPCX	160		200		250		315		400					
Port threads OSPC, OSPF	G <sup>1</sup> / <sub>2</sub>		G <sup>1</sup> / <sub>2</sub> -S**		M18 × 1.5 - O* + S**			¾-16 UNF - O*		for OLSA (only OSPC)				
Port threads OSPD	G <sup>1</sup> / <sub>2</sub> -S**			M18 × 1.5 - O* + S**				¾-16 UNF - O*						
Port threads OSPL, OSPLX	G <sup>1</sup> / <sub>2</sub>	¾-16 UNF - O*		For OPVL and without RV (LS = 7/16 - 20 UNF)					For OVPL and with RV (LS = G 1/4)					
Relief valve*** bar	70	80	90	100	110	120	140	170	190	200	210	no relief valve		
Shock valves bar	160		180		200		225		240		280		no shock valves	
Suction valves	Yes						No							
Check valve in LS	Yes (Only for OSPC dynamic, OSPD and OSPQ)						No (Only for OSPC, OSPF and OSPL)							
Neutral setting springs	Soft: 0.5 - 1.8 Nm in normal steering situations				Standard: 0.8 - 3 Nm in normal steering situations				Strong: 1.5 - 4 Nm in normal steering situations					
Unit black painted	Yes						No							





# Load Sensing Steering units, Priority valves and Flow amplifiers Technical Information

## LS Steering units OSPB, OSPC, OSPF, OSPD, OSPQ, OSPL

### **SPECIFICATION TABLE FOR NON CATALOGUE NUMBERS OF LS STEERING UNITS (CONTINUED)**

DP = Displacement, RV = Pilot pressure relief valve.  
O\*: O-ring chamfer on port connections.  
S\*\*: Spot face around port connections (can not be used in connection with OVR angular block).  
RV\*\*\* see "Technical data" page 29-30 for limitation in maximum pressure depending on displacements.  
Port and valve combinations possible: see tables page 26 - 28.  
Types not mentioned with port connections in the table above, are only available in the version(s) stated in the code number tables.

An alternative way to specify a variant is to state an existing code number and add the modifications, you would like to have implemented in the basic steering unit.

Code number of basic steering unit: \_\_\_\_\_

Requested modifications: \_\_\_\_\_

\_\_\_\_\_  
\_\_\_\_\_  
\_\_\_\_\_  
\_\_\_\_\_

**PORT THREAD VERSIONS  
 AND  
 VALVE COMBINATIONS**

The following combinations of port threads and valves are available for OSPC LS/LSR:  
 Housings for low flow: 40 - 200 cm<sup>3</sup>/rev [2.44 - 12.20 in<sup>3</sup>/rev] gear wheel set.

Threads			Valves			
Main ports (P, T, L, R)	LS-port	For steering column	Pilot pressure relief valve	Shock valves	Suction valves	Check valve in LS (only for LS Dynamic)
DIN 3852-2 G ½	DIN 3852-2 G ¼ w. spot face	M10 x 1,5	Yes	Yes	Yes	Yes
			Yes	Yes	Yes	No
DIN 3852-2 G ½ w. spot face	DIN 3852-2 G ¼ w. spot face	M10 x 1,5	Yes	Yes	Yes	Yes
			Yes	Yes	Yes	No
ISO 6149-1 M18 x 1,5, w. O-ring chamfer and spot face	ISO 6149-1 M12 x 1,5, w. O-ring chamfer and spot face	M10 x 1,5	Yes	Yes	Yes	Yes
			Yes	Yes	Yes	No
ISO 11926-1 ¾ - 16 UNF, O-ring boss port	ISO 11926-1 7/16 - 20 UNF O-ring boss port and spot face	3/8 - 16 UNC	Yes	Yes	Yes	Yes
			Yes	No	No	No
ISO 11926-1 ¾ - 16 UNF, O-ring boss port	ISO 11926-1 7/16 - 20 UNF O-ring boss port and spot face	M10 x 1,5	Yes	Yes	Yes	Yes
			Yes	Yes	Yes	Yes
For OLSA	For OLSA	M10 x 1,5	Yes	Yes	Yes	Yes
			Yes	Yes	Yes	No
			Yes	No	No	No

The following combinations of port threads and valves are available for OSPC LS/LSR:  
 Housings for high flow: 250 - 400 cm<sup>3</sup>/rev [15.25 - 24.4 in<sup>3</sup>/rev] gear wheel set.

Threads			Valves			
Main ports (P, T, L, R)	LS-port	For steering column	Pilot pressure relief valve	Shock valves	Suction valves	Check valve in LS (only for LS Dynamic)
DIN 3852-2 G ½	DIN 3852-2 G ¼ w. spot face	M10 x 1,5	Yes	Yes	Yes	No
			No	Yes	Yes	No
DIN 3852-2 G ½ w. spot face	DIN 3852-2 G ¼ w. spot face	M10 x 1,5	Yes	Yes	Yes	No
			Yes	No	No	Yes
ISO 11926-1 ¾ - 16 UNF, O-ring boss port	ISO 11926-1 7/16 - 20 UNF O-ring boss port and spot face	3/8 - 16 UNC	Yes	Yes	Yes	No
			Yes	No	No	No
			No	Yes	Yes	No
			No	Yes	No	No
ISO 11926-1 ¾ - 16 UNF, O-ring boss port	ISO 11926-1 7/16 - 20 UNF O-ring boss port and spot face	M10 x 1,5	Yes	Yes	Yes	No
			Yes	No	No	No
For OLSA	For OLSA	M10 x 1,5	Yes	Yes	Yes	No

Housings with spot face around port connections on main ports cannot be used in connection with OVR angular block.

**PORT THREAD VERSIONS  
 AND  
 VALVE COMBINATIONS  
 (CONTINUED)**

The following combinations of port threads and valves are available for OSPF LS:

Threads			Valves		
Main ports (P,T,L,R)	LS-port	For steering column	Pilot pressure relief valve	Shock valves	Suction valves
DIN 3852-2 G ½	DIN 3852-2 G ¼ w. spot face	M10 x 1,5	Yes	Yes	Yes
DIN 3852-2 G ½ w. spot face	DIN 3852-2 G ¼ w. spot face	M10 x 1,5	Yes	Yes	Yes
ISO 6149-1 M18 x 1.5, w. O-ring chamfer and spot face	ISO 6149-1 M12 x 1.5, w. O-ring chamfer and spot face	M10 x 1,5	Yes	Yes	Yes
			No	Yes	Yes
ISO 11926-1 ¾ - 16 UNF, O-ring boss port	ISO 11926-1 7/16 - 20 UNF O-ring boss port and spot face	¾ - 16 UNC	Yes	Yes	Yes
ISO 11926-1 ¾ - 16 UNF, O-ring boss port	ISO 11926-1 7/16 - 20 UNF O-ring boss port and spot face	M10 x 1,5	Yes	Yes	Yes

The following combinations of port threads and valves are available for OSPD LS/LSR:

Threads			Valves			
Main ports (P,T,L,R)	LS-port	For steering column	Pilot pressure relief valve	Shock valves	Suction valves	Check valve in LS (only for LS Dynamic)
DIN 3852-2 G ½ w. spot face	DIN 3852-2 G ¼ w. spot face	M10 x 1,5	Yes	Yes	Yes	Yes
ISO 6149-1 M18 x 1.5, w. O-ring chamfer and spot face	ISO 6149-1 M12 x 1.5, w. O-ring chamfer and spot face	M10 x 1.5	Yes	Yes	Yes	Yes
			Yes	Yes	Yes	No
ISO 11926-1 ¾ - 16 UNF, O-ring boss port	ISO 11926-1 7/16 - 20 UNF O-ring boss port and spot face	M10 x 1,5	Yes	Yes	Yes	Yes
			Yes	Yes	Yes	No

**PORT THREAD VERSIONS  
 AND  
 VALVE COMBINATIONS  
 (CONTINUED)**

The following combinations of port threads and valves are available for OSPQ LS/LSR:

Threads			Valves			
Main ports (P,T,L,R)	LS-port	For steering column	Pilot pressure relief valve	Shock valves	Suction valves	Check valve in LS (only for LS Dynamic)
ISO 6149-1 M18 x 1.5, w.O-ring chamfer and spot face	ISO 6149-1 M12 x 1.5, w.O-ring chamfer and spot face	M10 x 1.5	Yes	Yes	Yes	Yes
			No	Yes	Yes	Yes

Housings with spot face around port connections on main ports cannot be used in connection with OVR angular block.  
 For OSPL, OSPBX, OSPCX and OSPLX only the versions listed in the tables with code numbers are available.

**TECHNICAL DATA**

**Displacement, flow and pressure: OSPB LS, OSPC LS, OSPC LSR**

Common data: Look in sub catalogue: "General Steering Components"

Steering unit	Displacement cm <sup>3</sup> /rev [in <sup>3</sup> /rev]	*Rated oil flow l/min [US gal/min]	Max. pressure on connections		
			P bar [psi]	T bar [psi]	L. R bar [psi]
OSPC 40 LS Static	40 [2.44]	4 [1.06]	140 [2030]	40 [580]	280 [4061]
OSPB/OSPC 50 LS Static	50 [3.05]	5 [1.32]			
OSPC 60 LS Static	60 [3.66]	6 [1.58]			
OSPC 70 LS Static	70 [4.27]	7 [1.85]	175 [2538]		
OSPB/OSPC 80 LS Static	80 [4.88]	8 [2.11]			
OSPB/OSPC 100 LS Static	100 [6.10]	10 [2.64]			
OSPB/OSPC 125 LS Static	125 [7.63]	13 [3.43]	210 [3045]		
OSPB/OSPC 160 LS Static	160 [9.76]	16 [4.23]			
OSPC 185 LS Static	185 [11.29]	19 [5.02]			
OSPB/OSPC 200 LS Static	200 [12.20]	20 [5.28]	210 [3045]		
OSPC 230 LS Static	230 [14.03]	23 [6.07]			
OSPC 250 LS Static	250 [15.25]	25 [6.60]			
OSPB/OSPC 315 LS Static	315 [19.22]	32 [8.45]	210 [3045]		
OSPB/OSPC 400 LS Static	400 [24.41]	40 [10.57]			
OSPC 40 LS Dynamic	40 [2.44]	4 [1.06]		140 [2030]	
OSPB/OSPC 50 LS Dynamic	50 [3.05]	5 [1.32]			
OSPC 60 LS Dynamic	60 [3.66]	6 [1.58]			
OSPC 70 LS Dynamic	70 [4.27]	7 [1.85]	175 [2538]		
OSPB/OSPC 80 LS Dynamic	80 [4.88]	8 [2.11]			
OSPB/OSPC 100 LS Dynamic	100 [6.10]	10 [2.64]			
OSPB/OSPC 125 LS Dynamic	125 [7.63]	13 [3.43]	210 [3045]		
OSPB/OSPC 160 LS Dynamic	160 [9.76]	16 [4.23]			
OSPC 185 LS Dynamic	185 [11.29]	19 [5.02]			
OSPB/OSPC 200 LS Dynamic	200 [12.20]	20 [5.28]	210 [3045]		
OSPC 230 LS Dynamic	230 [14.03]	23 [6.07]			
OSPC 250 LS Dynamic	250 [15.25]	25 [6.60]			
OSPB/OSPC 315 LS Dynamic	315 [19.22]	32 [8.45]	210 [3045]		
OSPB/OSPC 400 LS Dynamic	400 [24.41]	40 [10.57]			
OSPC 40 LSR Dynamic	40 [2.44]	4 [1.06]		140 [2030]	
OSPC 50 LSR Dynamic	50 [3.05]	5 [1.32]			
OSPC 60 LSR Dynamic	60 [3.66]	6 [1.58]			
OSPC 70 LSR Dynamic	70 [4.27]	7 [1.85]	175 [2538]		
OSPC 80 LSR Dynamic	80 [4.88]	8 [2.11]			
OSPC 100 LSR Dynamic	100 [6.10]	10 [2.64]			
OSPC 125 LSR Dynamic	125 [7.63]	13 [3.43]	210 [3045]		
OSPC 160 LSR Dynamic	160 [9.76]	16 [4.23]			
OSPC 185 LSR Dynamic	185 [11.29]	19 [5.02]			
OSPC 200 LSR Dynamic	200 [12.20]	20 [5.28]	210 [3045]		

\*Rated flow at 100 rpm

**TECHNICAL DATA**

**Displacement, flow and pressure: OSPF LS**

Common data: Look in sub catalogue: "General Steering Components"

Steering unit	Displacement		*Rated oil flow		Max. pressure on connections		
	cm <sup>3</sup> /rev [in <sup>3</sup> /rev]		l/min [US gal/min]		P bar [psi]	T bar [psi]	L. R bar [psi]
OSPF 50 LS Dynamic	50	[3.05]	5	[1.32]	140 [2030]	40 [580]	280 [4061]
OSPF 60 LS Dynamic	60	[3.66]	6	[1.58]			
OSPF 70 LS Dynamic	70	[4.27]	7	[1.85]			
OSPF 80 LS Dynamic	80	[4.88]	8	[2.11]	175 [2538]		
OSPF 100 LS Dynamic	100	[6.10]	10	[2.64]			
OSPF 125 LS Dynamic	125	[7.63]	13	[3.43]			
OSPF 160 LS Dynamic	160	[9.76]	16	[4.23]	210 [3045]		
OSPF 185 LS Dynamic	185	[11.29]	19	[5.02]			
OSPF 200 LS Dynamic	200	[12.20]	20	[5.28]			
OSPF 230 LS Dynamic	230	[14.03]	23	[6.07]			
OSPF 250 LS Dynamic	250	[15.25]	25	[6.60]			
OSPF 315 LS Dynamic	315	[19.22]	32	[8.45]			
OSPF 400 LS Dynamic	400	[24.41]	40	[10.57]			

\*Rated flow at 100 rpm

**TECHNICAL DATA**

**Displacement, flow and pressure: OSPD LS, OSPQ LS**

OSPD and OSPQ steering units in the table below are all Load Sensing Dynamic type.

Common data: Look in sub catalogue: "General Steering Components"

Steering unit	Displacement manual steer mode		Displacement *normal steer mode		Rated oil flow**		Max. pressure on connections					
	cm <sup>3</sup> /rev	[in <sup>3</sup> /rev]	cm <sup>3</sup> /rev	[in <sup>3</sup> /rev]	l/min	[US gal/min]	P bar [psi]	T bar [psi]	L. R bar [psi]			
OSPD 60/185 LS	60	[3.66]	185	[11.29]	19	[5.02]	210 [3045]	40 [580]	280 [4061]			
OSPD 60/220 LS	60	[3.66]	220	[13.42]	22	[5.81]						
OSPD 60/260 LS	60	[3.66]	260	[15.87]	26	[6.87]						
OSPD 70/195 LS	70	[4.27]	195	[11.90]	20	[5.28]						
OSPD 70/230 LS	70	[4.27]	230	[14.03]	23	[6.07]						
OSPD 70/270 LS	70	[4.27]	270	[16.48]	27	[7.139]						
OSPD 70/385 LS	70	[4.27]	385	[23.49]	39	[10.30]						
OSPD 100/200 LS	100	[6.10]	200	[12.20]	20	[5.28]						
OSPD 100/260 LS	100	[6.10]	260	[15.87]	26	[6.87]						
OSPD 100/300 LS	100	[6.10]	300	[18.31]	30	[7.93]						
OSPD 125/285 LS	125	[7.63]	285	[17.39]	29	[7.66]						
OSPD 125/325 LS	125	[7.63]	325	[19.83]	33	[8.72]						
OSPD 125/440 LS	125	[7.63]	440	[26.85]	44	[11.62]						
OSPD 60/185 LSR	60	[3.66]	185	[11.29]	19	[5.02]	210 [3045]	40 [580]	280 [4061]			
OSPD 60/220 LSR	60	[3.66]	220	[13.42]	22	[5.81]						
OSPD 70/195 LSR	70	[4.27]	195	[11.90]	20	[5.28]						
OSPD 100/200 LSR	100	[6.10]	200	[12.20]	20	[5.28]						
OSPQ 80/125 LS	80	[4.88]	125	[7.63]	13	[3.43]	210 [3045]	40 [580]	280 [4061]			
OSPQ 80/140 LS	80	[4.88]	140	[8.54]	14	[3.70]						
OSPQ 80/160 LS	80	[4.88]	160	[9.76]	16	[4.23]						
OSPQ 100/160 LS	100	[6.10]	160	[9.76]	16	[4.23]						
OSPQ 100/180 LS	100	[6.10]	180	[10.98]	18	[4.75]						
OSPQ 100/200 LS	100	[6.10]	200	[12.20]	20	[5.28]						
OSPQ 125/200 LS	125	[7.63]	200	[12.20]	20	[5.28]						
OSPQ 125/250 LS	125	[7.63]	250	[15.25]	25	[6.60]						
OSPQ 160/250 LS	160	[9.76]	250	[15.25]	25	[6.60]						
OSPQ 160/320 LS	160	[9.76]	320	[19.53]	32	[8.45]						
OSPQ 80/125 LSR	80	[4.88]	125	[7.63]	13	[3.43]				210 [3045]	40 [580]	280 [4061]
OSPQ 80/140 LSR	80	[4.88]	140	[8.54]	14	[3.70]						
OSPQ 80/160 LSR	80	[4.88]	160	[9.76]	16	[4.23]						
OSPQ 100/160 LSR	100	[6.10]	160	[9.76]	16	[4.23]						
OSPQ 100/180 LSR	100	[6.10]	180	[10.98]	18	[4.75]						
OSPQ 100/200 LSR	100	[6.10]	200	[12.20]	20	[5.28]						
OSPQ 125/200 LSR	125	[7.63]	200	[12.20]	20	[5.28]						

\* normal steer mode: OSPQ: at a steering wheel speed higher than approximately 20 rpm, the amplification is fully active, and the displacements in the table are valid.

\*\* Rated flow at 100 rpm

**TECHNICAL DATA**

**Displacement, flow and pressure: OSPL LS, OSPBX LS, OSPCX LS, OSPLX LS**

Common data: Look in sub catalogue: "General Steering Components"

Steering unit	Displacement		*Rated oil flow		Max. pressure on connections		
	cm <sup>3</sup> /rev	[in <sup>3</sup> /rev]	l/min	[US gal/min]	P bar [psi]	T bar [psi]	L. R bar [psi]
OSPL 520 LS Static	520	[31.73]	52	[13.74]	210 [3045]	40 [580]	280 [4061]
OSPL 630 LS Static	630	[38.44]	63	[16.64]			
OSPL 800 LS Static	800	[48.82]	70**	[18.49]			
OSPL 1000 LS Static	1000	[61.02]	70**	[18.49]			
OSPL 520 LS Dynamic	520	[31.73]	52	[13.74]	240 [3081]	40 [580]	280 [4061]
OSPL 630 LS Dynamic	630	[38.44]	63	[16.64]			
OSPL 800 LS Dynamic	800	[48.82]	70**	[18.49]			
OSPL 1000 LS Dynamic	1000	[61.02]	70**	[18.49]			
OSPL 1200 Dynamic	1200	[73.22]	70**	[18.49]			
OSPBX 160 LS Static	160	[9.76]	16	[4.23]	210 [3045]	40 [580]	280 [4061]
OSPBX 200 LS Static	200	[12.20]	20	[5.28]			
OSPBX 250 LS Static	250	[15.25]	25	[6.60]			
OSPBX 315 LS Static	315	[19.22]	32	[8.45]			
OSPBX 400 LS Static	400	[24.41]	40	[10.57]			
OSPCX 160 LS Dynamic	160	[9.76]	16	[4.23]	210 [3045]	40 [580]	280 [4061]
OSPCX 200 LS Dynamic	200	[12.20]	20	[5.28]			
OSPCX 250 LS Dynamic	250	[15.25]	25	[6.60]			
OSPCX 315 LS Dynamic	315	[19.22]	32	[8.45]			
OSPCX 400 LS Dynamic	400	[24.41]	40	[10.57]			
OSPLX 520 LS Static	520	[31.73]	52	[13.74]	210 [3045]	40 [580]	280 [4061]
OSPLX 630 LS Static	630	[38.44]	63	[16.64]			
OSPLX 800 LS Static	800	[48.82]	70**	[18.49]			

\* Rated flow at 100 rpm

\*\* Please contact Sauer-Danfoss Sales Organization for flow higher than 70l/min [18.49 US gal/min].  
 70l/min [18.49 US gal/min] results in lower max. speed than 100 rpm on steering wheel for OSPL 800  
 and OSPL 1000 :

OSPL 800 max. speed at 70l/min [18.49 US gal/min] 87 rpm

OSPL 1000 max speed at 70l/min [18.49 US gal/min] 70 rpm



**TECHNICAL DATA**

**Valve functions in OSPC, OSPF, OSPD, OSPQ and OSPL LS steering units**

**Pilot pressure relief valve; (P - T, Qp) characteristic**

The pilot pressure relief valve protects the steering unit against excessive pressure. The pilot pressure relief valve in the OSPC LS, OSPF LS, OSPD LS, OSPQ LS and OSPL LS steering unit together with the priority valve limit the maximum steering pressure P-T. The pilot pressure relief valve is set at an oil flow to the priority valve of 25 l/min [6.60 US gal/min].

For OSPC, OSPD, OSPQ and OSPL load sensing dynamic steering units, the setting values are valid at a dynamic flow of 0.6 l/min [0.16 US gal/min].

For OSPF load sensing dynamic steering units, the setting values are valid at a dynamic flow of 1 l/min [0.26 US gal/min].

Setting tolerance:

<= 170 bar: rated value +5 bar [72.5 psi].

> 170 bar: rated value +10 bar [145 psi].

$$A = 170 \begin{matrix} +5 \\ -0 \end{matrix} \text{ bar } [2465 \begin{matrix} +73 \\ -0 \end{matrix} \text{ psi}]$$

$$B = 140 \begin{matrix} +5 \\ -0 \end{matrix} \text{ bar } [2030 \begin{matrix} +73 \\ -0 \end{matrix} \text{ psi}]$$

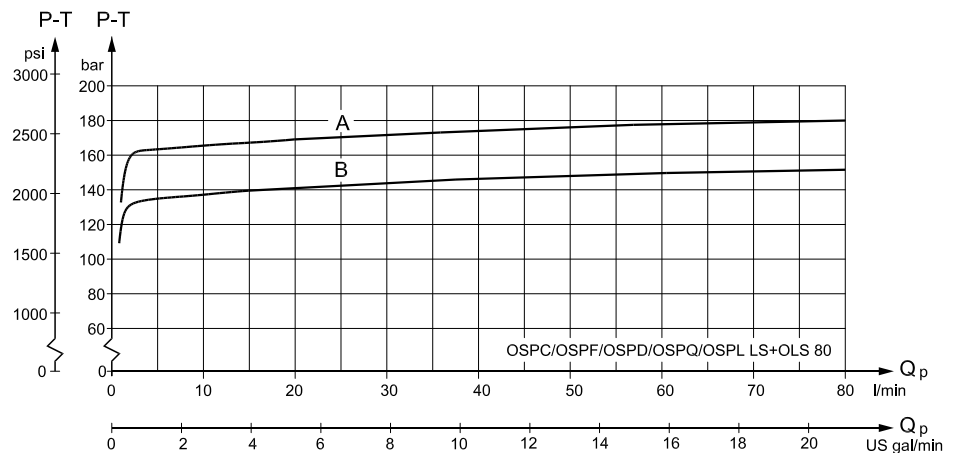

152B79.10

**Shock valves**

The shock valves protect the steering unit and reduce external forces on the steering cylinder by limiting the pressure difference from L to T and from R to T.

The shock valves are set at 1 l/min [0.264 US gal/min]

At higher flow pressure peaks may occur.

The shock valves are of the direct acting type, so they react very quickly.

Setting tolerance: rated value +20 bar [290 psi].

**TECHNICAL DATA**

**Suction valves**

The suction valves allow oil suction to avoid cavitation in the steering cylinder. To provide correct suction, a back pressure valve must be fitted in the tank line from the steering unit. Generally Sauer-Danfoss recommend a back pressure of 2 bar [29 psi], but on vehicles with strong self straightening tendencies and on articulated steered vehicles, we recommend 5-10 bar [72.5 - 145 psi]. For further advice, please contact the Sauer-Danfoss Sales Organisation.

Note: A connection which incorporates a check valve must be established to allow oil flow to by-pass the back pressure valve (and filter) from the tank to steering unit. See diagramme examples in sub catalogue "General Steering Components" page 37 - 39.

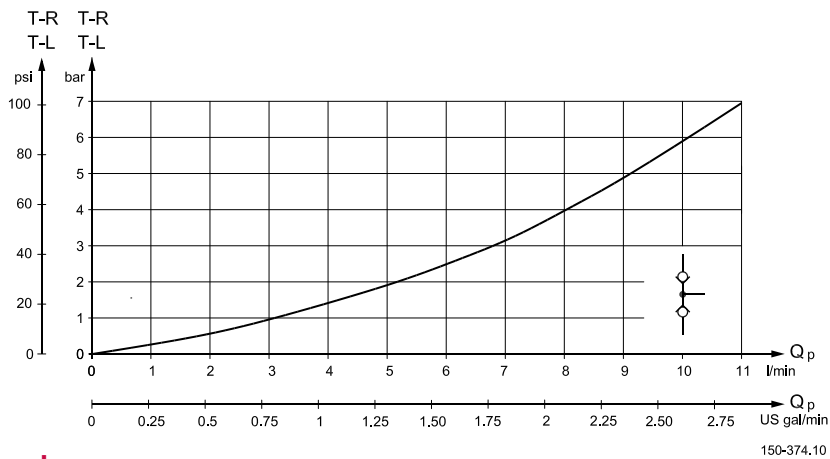

**Check valves**

The check valve in the P connection of the steering unit protects the driver against steering wheel jerks. The check valve prevents oil from flowing backwards into the pump line when steering against a high pressure on the cylinder side. The pressure drop across the check valve is indicated on the following graph, which assumes the use of port adaptors with 11 mm [0.43 in] minimum bore.

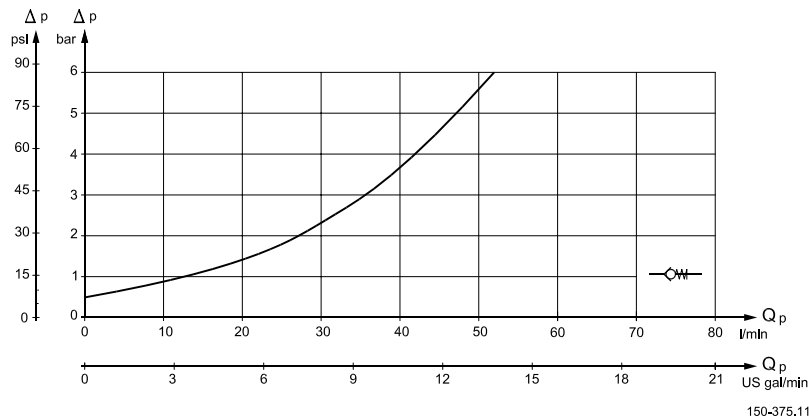

The check valve in the LS line of OSPC LS, OSPD LS and OSPQ LS dynamic steering units also protects the driver against steering wheel jerks. The check valve prevents oil from flowing backwards into the LS line to the priority valve when steering against a high pressure on the cylinder side.

In OSPF LS oil cannot flow backwards into the LS line, look in sub catalogue: "General Steering Components" page 26.

**PORT THREAD VERSIONS  
 FOR  
 OSPB LS,  
 OSPC LS/LSR,  
 OSPF LS,  
 OSPD LS/LSR,  
 OSPQ LS/LSR,  
 OSPL LS,  
 OSPBX LS,  
 OSPCX LS,  
 OSPLX LS**

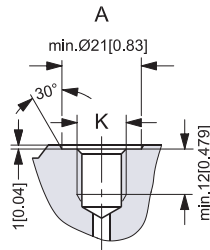

A: G port w. spot face  
 (LS in OSPB and OSPL  
 with no valves)  
 K: DIN 3852-2 - G ¼

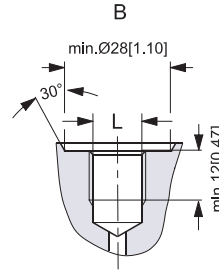

B: G port w. spot face  
 (LS in OSPC/F/D/Q  
 and OSPL with valves)  
 L: DIN 3852-2 - G ¼

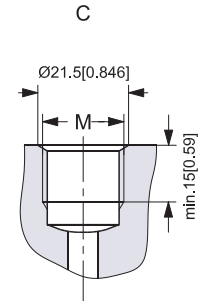

C: G ports (P, T, L, R)  
 M: DIN 3852-2 - G ½

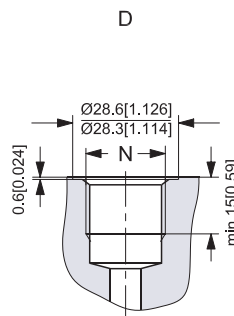

D: G ports w. spot face  
 (P, T, L, R)  
 N: DIN 3852-2 - G ½

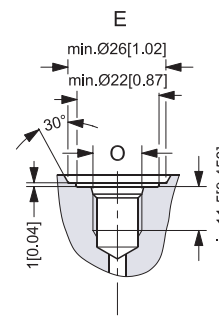

E: Metric port w. spot  
 face and O-ring  
 chamfer (LS)  
 O: ISO 6149-1 - M12 x 1.5

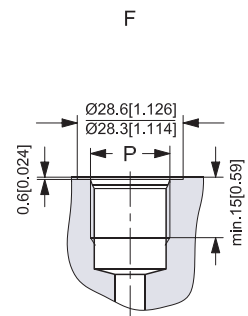

F: Metric ports  
 w. spot face and  
 O-ring chamfer  
 (P, T, L, R)  
 P: ISO 6149-1 - M18 x 1.5

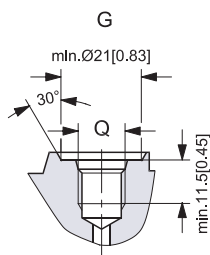

G: UNF port w. O-ring chamfer  
 (LS in OSPB  
 and OSPL with  
 no valves)  
 Q: ISO 11926-1 - 7/16-20UNF  
 O-ring boss port

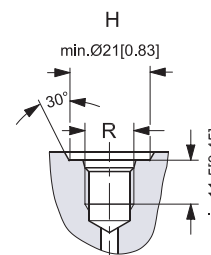

H: UNF ports w. O-ring  
 chamfer (LS in OSPC/  
 F/D and OSPL  
 with valves)  
 R: ISO 11926-1 - 7/16-20 UNF  
 O-ring boss port

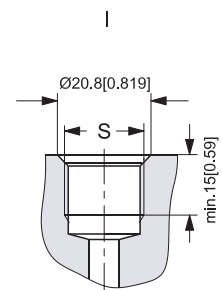

I: UNF ports w. O-ring  
 chamfer (P, T, L, R)  
 S: ISO 11926-1 - ¾-16UNF  
 O-ring boss port

150-603.10



**DIMENSIONS**

OSPC LS/LSR and OSPF LS for OLS, OSPCX LS for OSQ:

Type	L <sub>1</sub> mm [in]	L <sub>2</sub> mm [in]
OSPC 40	126 [4.96]	6.5 [0.26]
OSPC/OSPF 50	126 [4.96]	6.5 [0.26]
OSPC/OSPF 60	128 [5.04]	9.1 [0.36]
OSPC/OSPF 70	128 [5.04]	9.1 [0.36]
OSPC/OSPF 80	129 [5.08]	10.4 [0.41]
OSPC/OSPF 100	132 [5.20]	13.0 [0.51]
OSPC/OSPF 125	135 [5.31]	16.2 [0.64]
OSPC/OSPF OSPCX 160	140 [5.51]	20.8 [0.82]
OSPC/OSPF 185	143 [5.63]	24.0 [0.94]
OSPC/OSPF OSPCX 200	145 [5.71]	26.0 [1.02]
OSPC/OSPF 230	149 [5.87]	29.9 [1.18]
OSPC/OSPF OSPCX 250	151 [5.94]	32.5 [1.28]
OSPC/OSPF OSPCX 315	160 [6.30]	40.9 [1.61]
OSPC/OSPF OSPCX 400	171 [6.73]	52.0 [2.05]

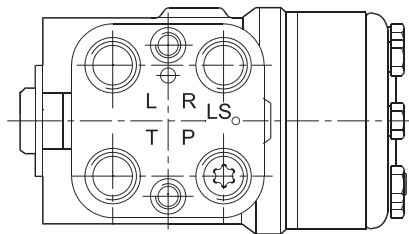
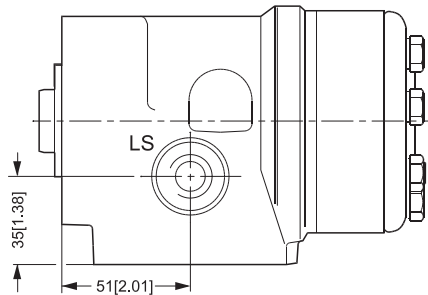
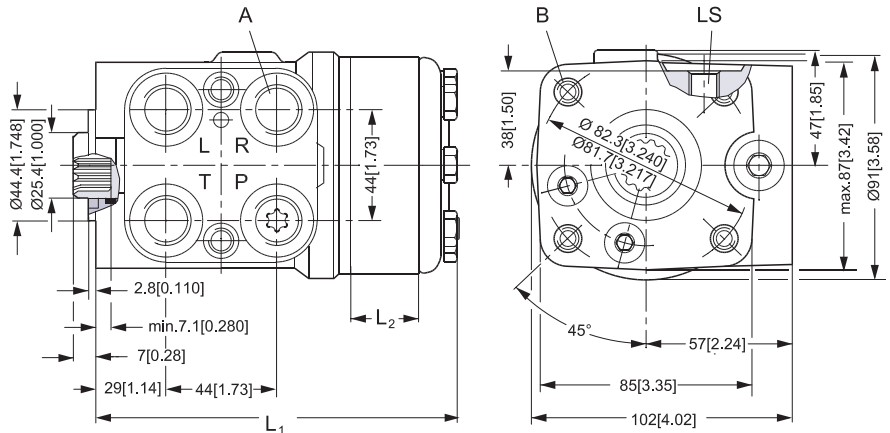

OSPC LS/LSR  
for OLSA

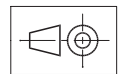

150-591.11

European version:

- A: G ½ or G ½ w. spot face  
or M18 x 1.5 ISO 6149,  
15 mm [0.59 in] deep
- B: M10 x 1.5, 16 mm [0.63 in]  
deep
- LS: G ¼ w. spot face  
or M12 x 1.5 ISO 6149,  
11.5 mm [0.45 in] deep

US version:

- A: ¾-16 UNF O-ring boss,  
15 mm (0.59 in) deep
- B: ¾-16 UNC or M10 x 1.5,  
16 mm  
[0.63 in] deep
- LS: 7/16 - 20 UNF O-ring boss,  
11.5 mm [0.45 in] deep

OSPC LS/LSR for OLSA:

- B: M10 x 1,5,  
16 mm [0.63 in] deep

**DIMENSIONS**

OSPD LS/LSR for OLS:

Type	L <sub>1</sub> mm [in]	L <sub>2</sub> mm [in]	L <sub>3</sub> mm [in]
OSPD 60/185	195 [7.70]	9.1 [0.36]	20.8 [0.82]
OSPD 60/220	200 [7.87]	9.1 [0.36]	26.0 [1.02]
OSPD 70/195	190 [7.48]	9.1 [0.36]	16.2 [0.65]
OSPD 70/230	195 [7.70]	9.1 [0.36]	20.8 [0.82]
OSPD 70/270	200 [7.87]	9.1 [0.36]	26.0 [1.02]
OSPD 70/385	215 [8.46]	9.1 [0.36]	40.9 [1.61]
OSPD 100/200	191 [7.52]	13.0 [0.51]	13.0 [0.51]
OSPD 100/260	199 [7.83]	13.0 [0.51]	20.8 [0.82]
OSPD 100/300	204 [8.03]	13.0 [0.51]	26.0 [1.02]
OSPD 125/285	202 [7.95]	16.2 [0.64]	20.8 [0.82]
OSPD 125/325	207 [8.15]	16.2 [0.64]	26.0 [1.02]
OSPD 125/440	222 [8.74]	16.2 [0.64]	40.9 [1.61]

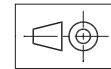
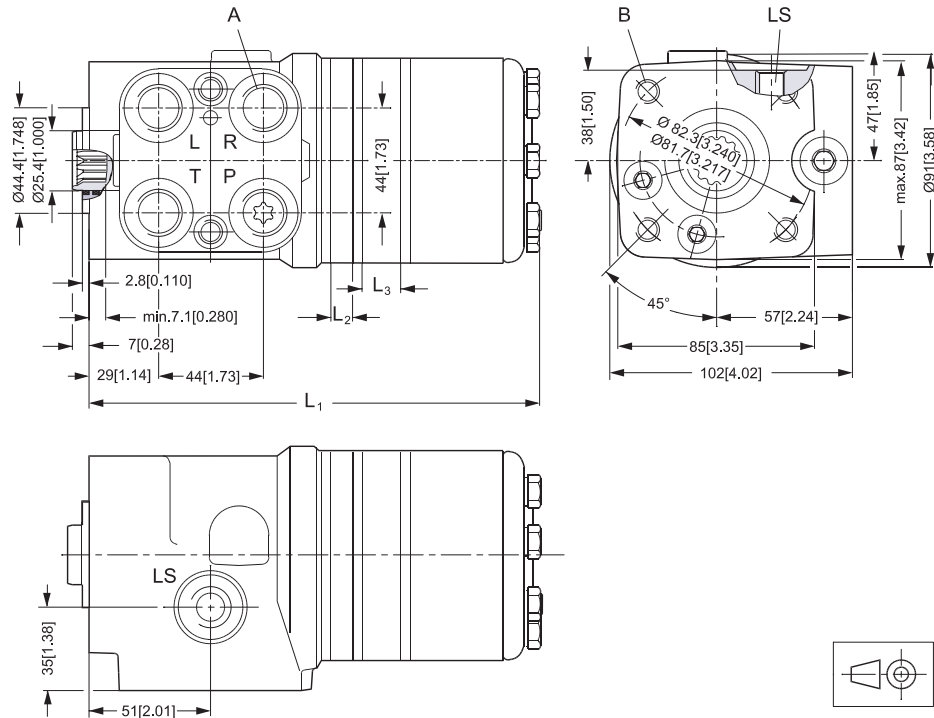

150-593.11

European version:

- A: G ½ w. spot-face  
or M18 × 1.5 ISO 6149  
15 mm [0.59 in] deep
- B: M10 × 1.5, 16 mm [0.63 in]  
deep
- LS: G ¼ w. spot face or  
M 12 × 1.5 ISO 6149  
11.5 mm [0.45 in] deep

US version:

- A: ¾ - 16 UNF O-ring boss;  
15 mm [0.59 in] deep
- B: M 10 × 1.5, 16 mm  
[0.63 in] deep,
- LS: 7/16 - 20 UNF o-ring boss,  
11.5 mm [0.45 in] deep

**DIMENSIONS**

OSPQ LS/LSR for OLS:

Type	L <sub>1</sub> mm [in]	L <sub>2</sub> mm [in]
OSPQ 80/125	129 [5.08]	10,4 [0.41]
OSPQ 80/140	129 [5.08]	10,4 [0.41]
OSPQ 80/160	129 [5.08]	10,4 [0.41]
OSPQ 100/160	132 [5.20]	13,0 [0.51]
OSPQ 100/180	132 [5.20]	13,0 [0.51]
OSPQ 100/200	132 [5.20]	13,0 [0.51]
OSPQ 125/200	135 [5.31]	16,2 [0.64]
OSPQ 125/250	135 [5.31]	16,2 [0.64]
OSPQ 160/250	140 [5.51]	20,8 [0.82]
OSPQ 160/320	140 [5.51]	20,8 [0.82]

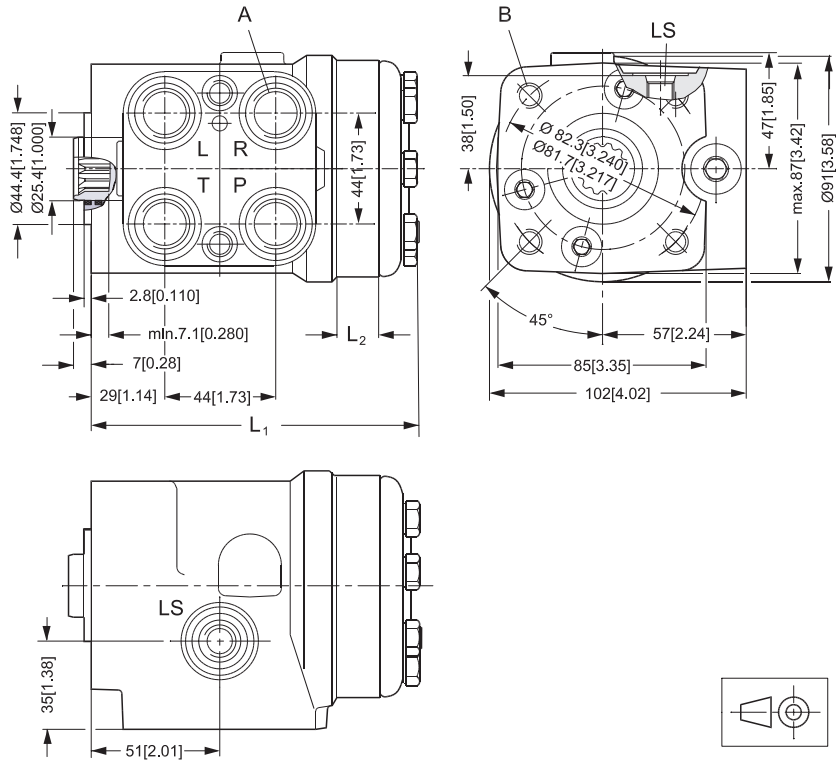

European version:

A: M18 x 1.5 ISO 6149,  
 15 mm [0.59 in] deep

B: M10 x 1.5, 16 mm [0.63 in]  
 deep

LS: M12 x 1.5 ISO 6149,  
 11.5 mm [0.45 in] deep

150-594.12





**DIMENSIONS**

OSPL 1200 LS for OLS:

Type	L <sub>1</sub> mm [in]	L <sub>2</sub> mm [in]	L <sub>3</sub> mm [in]
OSPL	288	104	52
1200 LS	[10.34]	[4.09]	[2.05]

- A: 3/4-16 UNF O-ring boss,  
15 mm [0.59 in] deep
- B: M10 x 1.5, 16 mm [0.63 in] deep
- LS: 7/16-20 UNF O-ring boss  
11.5 mm [0.45 in] deep

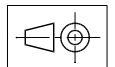
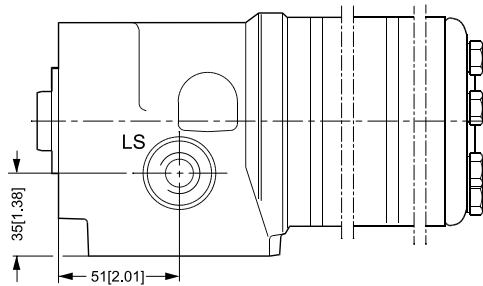
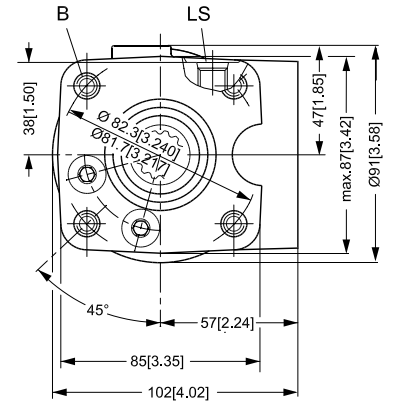
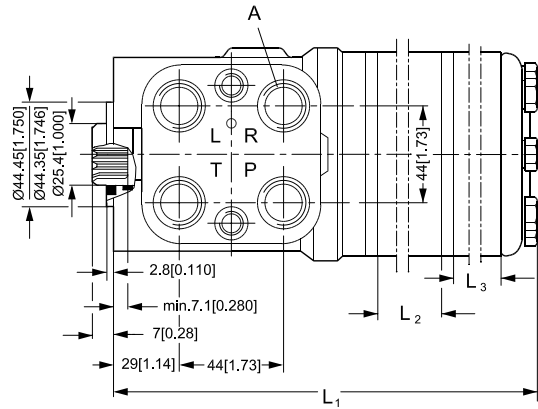

150-612.10

**Sauer-Danfoss priority valves are used in steering systems with load sensing steering units. In such systems steering always has first priority.**

**VERSIONS**

*Load sensing static priority valves*

Load sensing static steering units require load sensing static priority valves. Load sensing static steering systems have no oil flow in the LS connection when the steering unit is in neutral position.

*Load sensing dynamic priority valves*

Load sensing dynamic steering units require load sensing dynamic priority valves. Load sensing dynamic steering systems have a constant oil flow in the LS connection from the priority valve to the steering unit even when the steering unit is in neutral position.

Ports:

- P = pump,
- CF = controlled flow (priority oil flow),
- EF = excess flow,
- L = left,
- R = right,
- T = tank,
- LS = load sensing,
- PP = pilot pressure

**OLSA 40/80**

The OLSA 40 and OLSA 80 "flange on" priority valves are used in load sensing steering systems, built onto OSPC LS (OLSA) steering units.



F300625

*OLSA static*

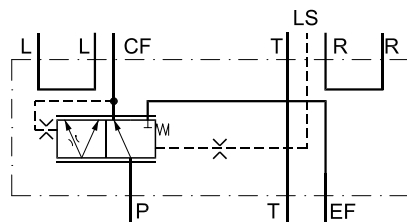

152B135.11

*OLSA dynamic*

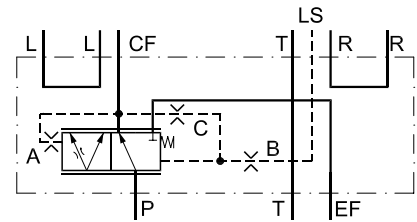

152B170.11

- A: PP-damping orifice
- B: LS-orifice
- C: Dynamic-orifice

**VERSIONS**

The OLS 40, OLS 80 and OLS 120 "in line" priority valves are used in load sensing steering systems together with OSPB LS, OSPC LS, OSPF LS, OSPD LS, OSPQ LS and OSPL LS steering units.

**OLS 40/80**



F300624

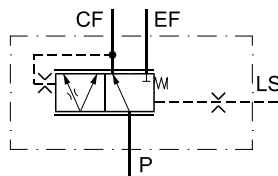

152B134.10

*OLS static*

**OLS 120**



F300623

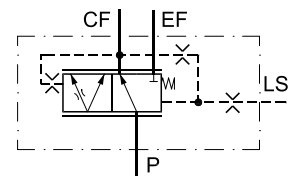

152B171.10

*OLS dynamic*

The OLS 160 "in line" priority valve is used in load sensing steering systems together with OSPB LS, OSPC LS, OSPF LS, OSPD LS, OSPQ LS and OSPL LS steering units.

**OLS 160**

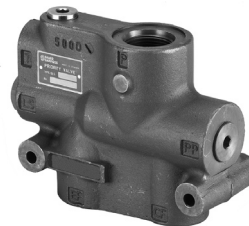

F300622

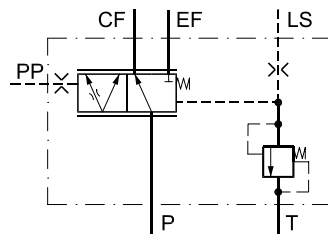

152B137.11

*OLS static*

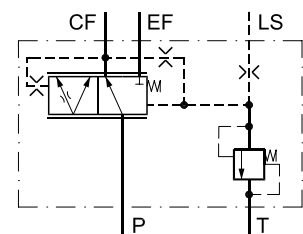

152B172.11

*OLS dynamic*

OLS 160 is also available without pilot pressure relief valve.

### VERSIONS (CONTINUED)

The priority valve OLSP 80 is to be used in connection with e.g. Sauer-Danfoss gear pumps type SNP and steering units type OSPB LS, OSPC LS, OSPF LS, OSPD LS and OSPQ LS in load sensing steering systems, where maximum oil flow doesn't exceed 80 l/min [21.7 USgal/min].

OLSP 80 priority valves are to be flanged on gear pumps with outlet ports square flange type 35 (35 mm pitch diameter of 4x M6 bolt holes for fixing the priority valve on pump).

### OLSP 80

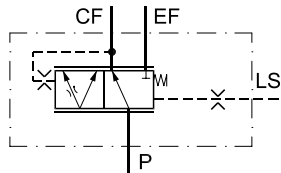

152B134.10

*OLSP static*

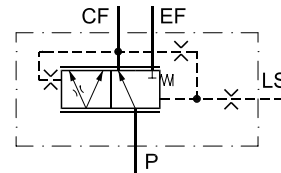

152B171.10

*OLSP dynamic*

The priority valve OLS 320 is to be used in connection with large pumps and steering units type OSPB LS, OSPC LS, OSPF LS, OSPD LS, OSPQ LS and OSPL LS or with EHPS steering valve in load sensing steering systems, where maximum oil flow doesn't exceed 320 l/min [84.5 USgal/min].

### OLS 320

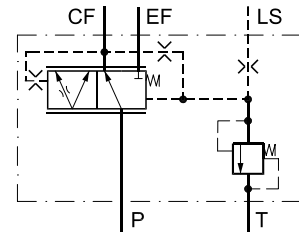

152B172.11

EHPS steering valve has built in priority valve, but for max. pump flow 120 l/min [31.7 USgal/min]. In systems with EHPS and pump flow between 120 l/min [31.7 USgal/min] and 320 l/min [84.5 USgal/min] a combination of EHPS and OLS 320 gives a good compact solution to reduce hosing and installation cost compared with stand alone components. For further details of this OLS 320: look in EHPS catalogue 520L0521.

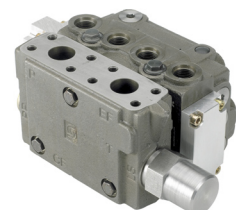

### SYSTEM SIZING

The steering system pump is sized so that satisfactory performance is achieved for both steering and working hydraulics - even at idle.

Before selecting a priority valve, consider

- the type of steering unit (LS static, LS dynamic or OSPF LS dynamic)
- the displacement of the steering unit
- the pump flow
- the application's requirement for energy optimization, initial steering response time and stability, as these all govern the selection for control spring pressure
- whether the priority valve should have internal PP (Pilot Pressure) or external PP-connection depends on the pressure drop in the pump line between the priority valve's CF-port (Controlled Flow) and the steering unit's P-port. With normal hose and tube dimensions and less than 5 m distance between priority valve and steering unit, the immediate choice is normally a priority valve with internal PP.

The following survey lists the code numbers of the priority valves that are the most frequently used in connection with the above Sauer-Danfoss steering unit types. All priority valves in the code number tables, except OLS 160 static, have internal PP connection. OLS 160 static in the code number table all have external PP connection.

### CODE NUMBERS AND WEIGHTS

#### OLS/OLSA static priority valves for load sensing static steering units

*OLSA 40 static and OLSA 80 static*

Priority valve	Code Numbers		Control spring pressure		Weight	
	Connections					
	European version	US version	bar	[psi]	kg	[lb]
	T, R, L: G $\frac{3}{8}$ P, EF: G $\frac{1}{2}$	T, R, L: $\frac{9}{16}$ - 18 UNF P, EF: $\frac{7}{8}$ - 14 UNF				
OLSA 40	152B0001	-	4	[58]	2,1	[4.63]
OLSA 40	152B0002	152B0122	7	[101.5]	2,1	[4.63]
OLSA 40	152B0003	152B0124	10	[145]	2,1	[4.63]
OLSA 80	152B0016	152B0019	4	[58]	2,1	[4.63]
OLSA 80	152B0017	152B0020	7	[101.5]	2,1	[4.63]
OLSA80	152B0015	152B0125	10	[145]	2,1	[4.63]

*OLS 40 static and OLS 80 static*

Priority valve	Code Numbers		Control spring pressure		Weight	
	Connections					
	European version	US version	bar	[psi]	kg	[lb]
	LS: G $\frac{1}{4}$ P, EF, CF: G $\frac{1}{2}$	LS: $\frac{7}{16}$ - 20 UNF CF: $\frac{3}{4}$ - 16 UNF P, EF: $\frac{7}{8}$ - 14 UNF				
OLS 40	152B0231	152B0237	4	[58]	1,0	[2.2]
OLS 40	152B0232	152B0238	7	[101.5]	1,0	[2.2]
OLS 40	152B0233	152B0253	10	[145]	1,0	[2.2]
OLS 80	152B0261	152B0267	4	[58]	1,0	[2.2]
OLS 80	152B0262	152B0268	7	[101.5]	1,0	[2.2]
OLS 80	152B0263	152B0280	10	[145]	1,0	[2.2]

**CODE NUMBERS AND WEIGHTS**

**OLS/OLSA static priority valves for load sensing static steering units**

*OLS 120 static*

Priority valve	Code Numbers		Control spring pressure	Weight
	Connections			
	European version	US version		
	LS: G ¼ CF: G ½ P, EF: G ¾	LS: 7/16 -20 UNF CF: ¾ - 16 UNF P, EF: 1 1/16 - 12 UNF	bar [psi]	kg [lb]
OLS 120	152B2232	152B2238	7 [101.5]	2.1 [4.63]
OLS 120	152B2233	152B2239	10 [145]	2.1 [4.63]

*OLS 160 static*

Priority valve	Code Numbers		Control spring pressure	Pilot pressure relief valve	Weight
	Connections				
	European version	US version			
	LS, PP, T: G ¼ CF: G ½ P, EF: G ¾	LS, PP, T: 7/16 -20 UNF CF: ¾ - 16 UNF P, EF: 1 1/16 - 12 UNF	bar [psi]	bar [psi]	kg [lb]
OLS 160	152B1005	152B1085	7 [101.5]	170 [2465]	4.4 [9.7]
OLS 160	152B1006	152B1086	10 [145]	170 [2465]	4.4 [9.7]

**OLS/OLSA dynamic priority valves for load sensing dynamic steering units**

*OLSA 40 dynamic and OLSA 80 dynamic for OSPC LS dynamic*

Priority valve	Code Numbers		Control spring pressure	Weight
	Connections			
	European version	US version		
	T,R,L: G 3/8 P/EF: G ½	T,R,L: 9/16 - 18 UNF P/EF: 7/8 - 14 UNF	bar [psi]	kg [lb]
OLSA 40	152B8001	-	4 [58]	2.1 [4.63]
OLSA 40	152B8041	152B8042	7 [101.5]	2.1 [4.63]
OLSA 40	152B8046	152B8043	10 [145]	2.1 [4.63]
OLSA 80	152B8047	-	4 [58]	2.1 [4.63]
OLSA 80	152B8048	152B8044	7 [101.5]	2.1 [4.63]
OLSA 80	152B8049	152B8045	10 [145]	2.1 [4.63]

**CODE NUMBERS AND WEIGHTS**

**OLS/OLSA dynamic priority valves for load sensing dynamic steering units**

*OLS 40 dynamic and OLS 80 dynamic for OSPB, OSPC, OSPD, OSPQ and OSPL LS dynamic*

Priority valve	Code Numbers		Control spring pressure bar [psi]	Weight kg [lb]	
	Connections				
	European version LS: G ¼ P, EF, CF: G ½	US version LS: 7/16 - 20 UNF CF: ¾ - 16 UNF P, EF: 7/8 - 14 UNF			
OLS 40	152B8231	-	4 [58]	1.0 [2.20]	
OLS 40	152B8232	152B8253	7 [101.5]	1.0 [2.20]	
OLS 40	152B8233	152B8254	10 [145]	1.0 [2.20]	
OLS 80	152B8261	-	4 [58]	1.0 [2.20]	
OLS 80	152B8256	152B8268	7 [101.5]	1.0 [2.20]	
OLS 80	152B8257	152B8260	10 [145]	1.0 [2.20]	

*OLS 80 dynamic with low pressure drop (P-EF) spool for OSPB, OSPC, OSPD, OSPQ and OSPL LS dynamic*

Priority valve	Code Numbers	Control spring pressure bar [psi]	Weight kg [lb]	
	Connections European version LS: G ¼ P, EF, CF: G ½			
OLS 80	152B8259	7 [101.5]	1.0 [2.2]	

*OLS 120 dynamic for OSPB, OSPC, OSPD, OSPQ and OSPL LS dynamic*

Priority valve	Code Numbers		Control spring pressure bar [psi]	Weight kg [lb]	
	Connections				
	European version LS: G ¼ CF: G ½ P, EF: G ¾	US version LS: 7/16 - 20 UNF CF: ¾ - 16 UNF P, EF: 1 1/16 - 12 UNF			
OLS 120	152B8132	152B8143	7 [101.5]	2.1 [4.63]	
OLS 120	152B8133	152B8144	10 [145]	2.1 [4.63]	

*OLS 160 dynamic for OSPB, OSPC, OSPD, OSPQ and OSPL LS dynamic*

Priority valve	Code Numbers		Control spring pressure bar [psi]	Pilot pressure relief valve bar [psi]	Weight kg [lb]	
	Connections					
	European version LS, T: G ¼ CF: G ½ P, EF: G ¾	US version LS, T: 1/16 - 20 UNF CF: ¾ - 16 UNF P, EF: 1 1/16 - 12 UNF				
OLS 160	152B8159	152B8154	7 [101.5]	170 [2465]	4.4 [9.7]	
OLS 160	152B8160	152B8155	10 [145]	170 [2465]	4.4 [9.7]	
OLS 160	152B8105	-	12 [174]	170 [2465]	4.4 [9.7]	
OLS 160	152B8161	152B8156	7 [101.5]	210 [3045]	4.4 [9.7]	
OLS 160	152B8162	152B8157	10 [145]	210 [3045]	4.4 [9.7]	

**CODE NUMBERS AND WEIGHTS**

**OLS dynamic priority valves for OSPF LS dynamic steering units**

*OLS 40 dynamic and OLS 80 dynamic*

Priority valve	Code Numbers	Control spring pressure		Weight	
	Connections European version LS: G ¼ P, EF, CF: G ½				
OLS 40	152B8031	10	[145]	1.0	[2.20]
OLS 80	152B8258	7	[101.5]	1.0	[2.20]

*OLS 120 dynamic*

Priority valve	Code Numbers	Control spring pressure		Weight	
	Connections European version LS: G ¼, CF: G ½ P, EF, CF: G ¾				
OLS 120	152B8147	7	[101.5]	2.1	[4.63]

*OLS 160 dynamic*

Priority valve	Code Numbers	Control spring pressure		Pilot pressure relief valve	Weight	
	Connections European version LS: G ¼, CF: G ½ P, EF, CF: G ¾					
OLS 160	152B8158	7	[101.5]	none	4.4	[9.7]
OLS 160	152B8113	10	[145]	none	4.4	[9.7]

*OLSP static and dynamic*

Priority valve	Code numbers	Control spring pressure		Weight	
	Connections European version LS: G ¼ CF: G ¾ EF: G ½				
OLSP 80 static	152B5002	4	[58]	1.0	[2.2]
OLSP 80 dynamic	152B5200	7	[101.5]	1.0	[2.2]
OLSP 80 dynamic for OSPF	152B5201	7	[101.5]	1.0	[2.2]



**OLS dynamic priority valves for OSPF LS dynamic steering units (continued)**

*OLS 320 dynamic in-line/stand alone with pilot pressure relief valve, black painted*

Priority valve	Code numbers	Control spring pressure		Pilot pressure relief valve		Weight	
	Connections European version LS, T: G ¼ CF: G ½ P, EF: G 1						
		bar	[psi]	bar	[psi]	kg	[lb]
OLS 320	11006593	7	[101.5]	170	[2465]	5.9	[13.0]

*OLS 320 dynamic in-line/stand alone without pilot pressure relief valve, black painted*

Priority valve	Code numbers	Control spring pressure		Weight	
	Connections European version LS: 7/16 - 20 UNF CF: 1 1/16-12UN P, EF: 1 5/16-12UN				
		bar	[psi]	kg	[lb]
OLS 320	11007475	10	[145]	5.9	[13.0]

OLS 320 for EHPS: look in EHPS catalogue 520L0521

If you require other port connections, other control spring pressure and/or other PP connection, go to the survey on page 50, and tick off the desired specifications, then consult the Sauer-Danfoss Sales Organization.

**SPECIFICATION TABLE FOR NON CATALOGUE NUMBERS OF SAUER-DANFOSS PRIORITY VALVES**

Your company	Name				Vehicle				Potential, pcs/year				Completed by		Date	
Your application	Pump flow to OLS/OLSA at idle, l/min [USgal/min]								Pump flow to OLS/OLSA at max. engine speed, l/min [USgal/min]							
Priority valve type	OLS A 40		OLS A 80		OLS 40		OLS 80		OLS 120		OLS 160		OLSP 80		OLS 320 in-line	
Load sensing type	Static				Dynamic				Dynamic for OSPF steering unit							
Spool type	Standard		Low pressure drop, P-EF (only OLS/OLSA 80 dynamic)						No CF cut-off (only for OLS 320 for flanging on EHPS)							
Control spring, bar	4 (only OLS 80, 120, 160, OLSP 80)				5.5 (only OLS/OLSA 40/80)				7		10		12 (only OLS 160)		16 (only OLS 160)	
PP connection	Internal								External (not OLSP)							
Ports, OLSA	G: P, EF: G $\frac{1}{2}$ - S** T, L, R: G $\frac{3}{8}$ - S**		Metric 1: P, EF, T, L, R: M18 • 1.5 - O*** + S**		Metric 2: P, EF: M22 • 1.5 - O*** + S** T, L, R: M18 • 1.5 - O*** + S**		UNF: P, EF: $\frac{7}{8}$ - 14 UNF - O*** T, L, R: $\frac{9}{16}$ - 18 UNF - O***									
Ports, OLS 40/80	G: P, CF, EF: G $\frac{1}{2}$ - S** LS: G $\frac{1}{2}$ - S**		Metric: P, EF: M22 • 1.5 - O*** + S** CF: M18 • 1.5 - O*** + S** LS: M12 • 1.5 - O*** + S**		UNF: P, EF: $\frac{7}{8}$ - 14 UNF - O*** CF: $\frac{3}{4}$ - 16 UNF - O*** LS: $\frac{7}{16}$ - 20 UNF - O***											
Ports, OLS 120	G: P, EF: G $\frac{3}{4}$ - S** CF: G $\frac{1}{2}$ - S** LS, PP: G $\frac{1}{4}$ - S**		Metric: P, EF: M27 • 2 - O*** + S** CF: M18 • 1.5 - O*** + S** LS: M12 • 1.5 - O*** + S**		UNF: P, EF: $1\frac{1}{16}$ - 14 UNF - O*** CF: $\frac{3}{4}$ - 16 UNF - O*** LS: $\frac{7}{16}$ - 20 UNF - O***											
Ports, OLS 160	G 1: P, EF: G $\frac{3}{4}$ - S** CF: G $\frac{1}{2}$ - S** LS, PP, T: G $\frac{1}{4}$ - S**		G 2: P, EF: G1 - S** CF: G $\frac{3}{4}$ - S** LS, PP, T: G $\frac{1}{4}$ - S**		UNF 1: P, EF: $1\frac{1}{16}$ - 12 UN - O*** CF: $\frac{3}{4}$ - 16 UNF - O*** LS, PP, T: $\frac{7}{16}$ - 20 UNF - O***				UNF 2: P, EF: $1\frac{5}{16}$ - 12 UN - O*** CF: $\frac{7}{8}$ - 14 UNF - O*** LS, PP, T: $\frac{7}{16}$ - 20 UNF - O***							
Ports, OLSP 80 (P: square flange 35)	G: EF: G $\frac{1}{2}$ - S** CF: G $\frac{3}{8}$ - S** LS: G $\frac{1}{4}$ - S**		Metric: EF: M22 • 1.5 - O*** + S** CF: M18 • 1.5 - O*** + S** LS: M12 • 1.5 - O*** + S**		UNF: EF: $\frac{7}{8}$ - 14 UNF - O*** CF: $\frac{3}{4}$ - 16 UNF - O*** LS: $\frac{7}{16}$ - 20 UNF - O***											
Ports, OLS 320 in-line	G: P, EF: G1 - S** CF: G $\frac{1}{2}$ - S** LS, PP: G $\frac{1}{4}$ - S**		UNF 1: P, EF: $1\frac{5}{16}$ - 12 UN - O*** CF: $\frac{3}{4}$ - 16 UNF - O*** LS, PP, T: $\frac{7}{16}$ - 20 UNF - O***		UNF 2: P, EF: $1\frac{5}{16}$ - 12 UN - O*** CF: $\frac{1}{16}$ - 12 UNF - O*** LS, PP, T: $\frac{7}{16}$ - 20 UNF - O***											
RV-bar OLS 160 OLS 320	80	90	100	110	120	140	170	190	200	210	Other settings		No relief valve			
Unit black painted	Yes										No					

**SPECIFICATION TABLE  
 FOR NON CATALOGUE  
 NUMBERS OF SAUER-  
 DANFOSS PRIORITY  
 VALVES  
 (CONTINUED)**

Ports: PP-port only exists when external PP connection is used. T-port only exists for OLS 160 and OLS 320 with integrated pilot pressure relief valve (RV)  
 O\*: O-ring chamfer on port connections  
 S\*\*: Spot face around port connections

An alternative way to specify a variant is to state an existing code number and add the modifications, you would like to have implemented in the basic steering unit.

Code number of basic steering unit: \_\_\_\_\_

Requested modifications: \_\_\_\_\_

\_\_\_\_\_

\_\_\_\_\_

\_\_\_\_\_

\_\_\_\_\_

**TECHNICAL DATA**

**Max. pressure on connections**

Priority valve valve	Rated flow to P-connection l/min [US gal/min]	Max. pressure on connections											
		P, EF		CF		L, R		LS		T		PP	
		bar	[psi]	bar	[psi]	bar	[psi]	bar	[psi]	bar	[psi]	bar	[psi]
OLSA 40	40 [10.57]	250	[3625]	210	[3045]	280	[4061]	210	[3045]	20	[290]		
OLSA 80	80 [21.13]	250	[3625]	210	[3045]	280	[4061]	210	[3045]	20	[290]		
OLS 40	40 [10.57]	250	[3025]	210	[3045]			210	[3045]			210	[3045]
OLS 80	80 [21.13]	250	[3025]	210	[3045]			210	[3045]			210	[3045]
OLS 120	120 [31.70]	250	[3025]	210	[3045]			210	[3045]			210	[3045]
OLS 160	160 [42.27]	350	[5076]	210	[3045]			210	[3045]	15	[217]	210	[3045]
OLSP 80	80 [21.13]	250	[3025]	210	[3045]			210	[3045]				
OLS 320	320 [84.54]	300	[4351]	280	[4061]			280	[4061]	40	[580]	280	[4061]

**PRESSURE DROP IN PRIORITY VALVES**

**Pressure drop in priority valves**

This data comes from measurements on a representative sample of priority valves from production. Oil with viscosity of 21 mm<sup>2</sup>/s at 50 °C [102 SUS at 122 °F] was used during measuring. Measurement made when pressure on the LS connection is zero (steering unit in neutral position). The minimum curves apply when the pressure on the EF connection is higher than the actual control spring pressure. The curves for control spring pressure of 4 , 7 , 10 or 12 bar [58 , 101 , 145 or 174 psi] apply when pressure on the EF connection is zero.

**Pressure drop P-EF for static priority valves**

*OLSA/OLS 40*

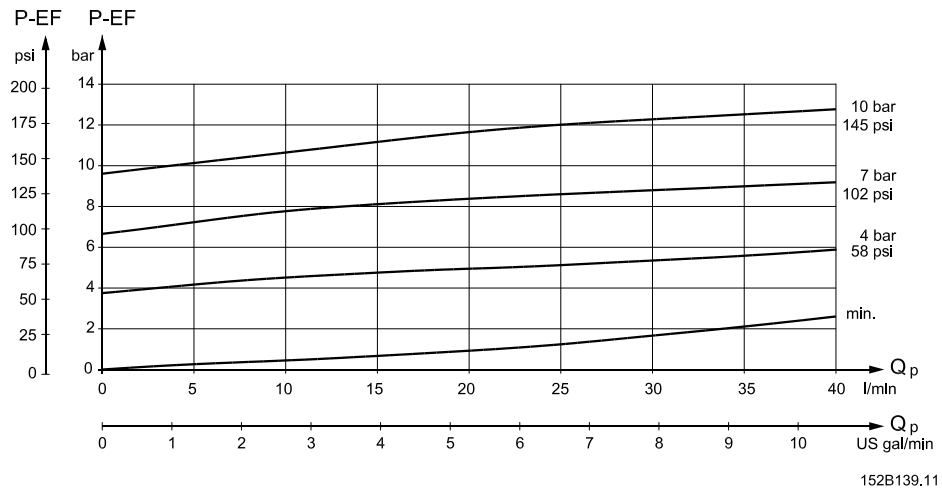

*OLSA/OLS 80*

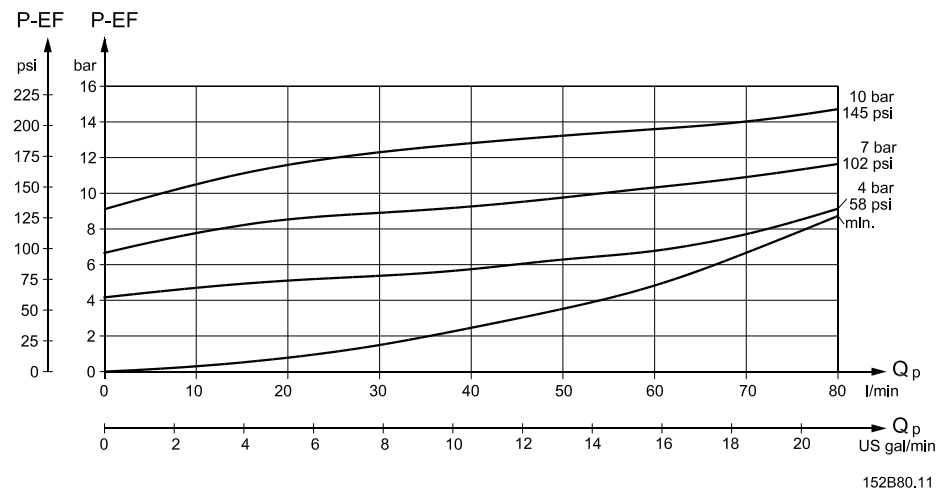

**TECHNICAL DATA**

**Pressure drop P-EF for static priority valves**

*OLS 120*

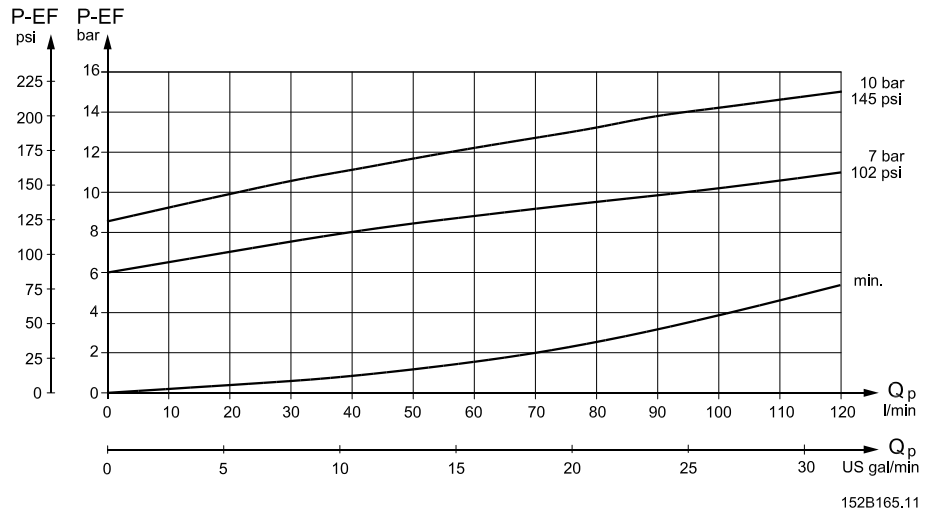

*OLS 160*

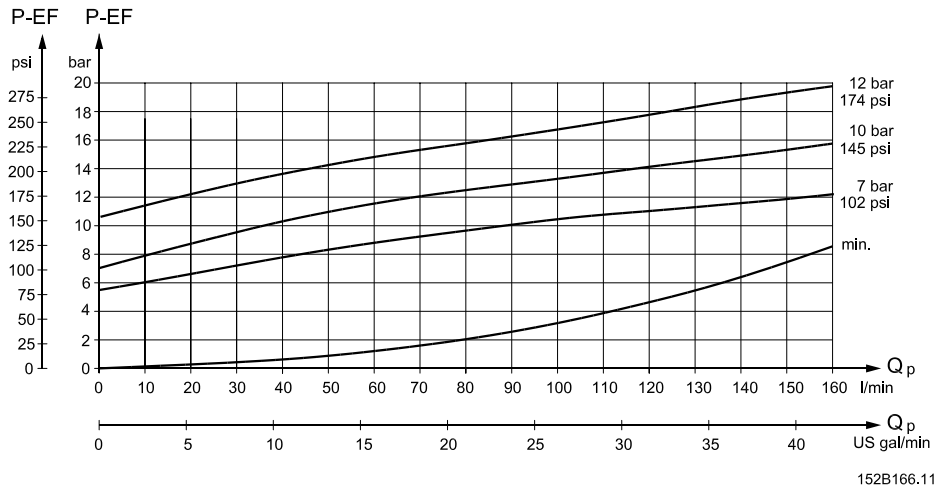

TECHNICAL DATA

Pressure drop P-EF for dynamic priority valves

OLSA/OLS 40

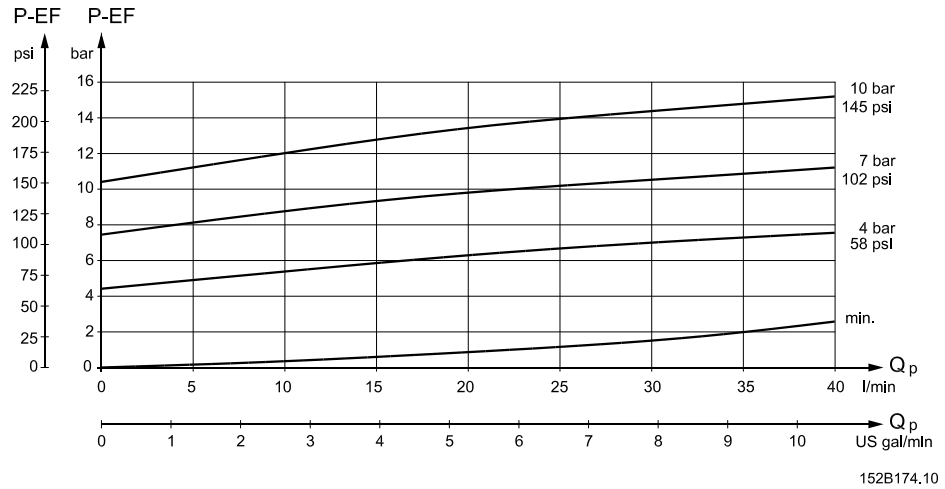

OLSA/OLS 80

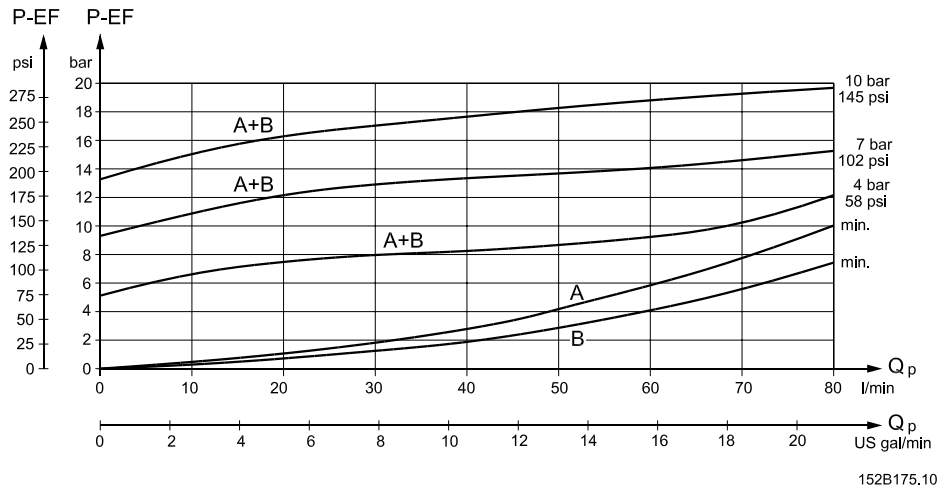

A: OLS/OLSA 80 Dynamic for OSPB, OSPC, OSPF, OSPD, OSPQ, OSPL LS Dynamic

B: OLS/OLSA 80 Dynamic with low pressure drop (P-EF) spool for OSPB, OSPC, OSPD, OSPQ, OSPL LS Dynamic

TECHNICAL DATA

Pressure drop P-EF for dynamic priority valves

OLS 120

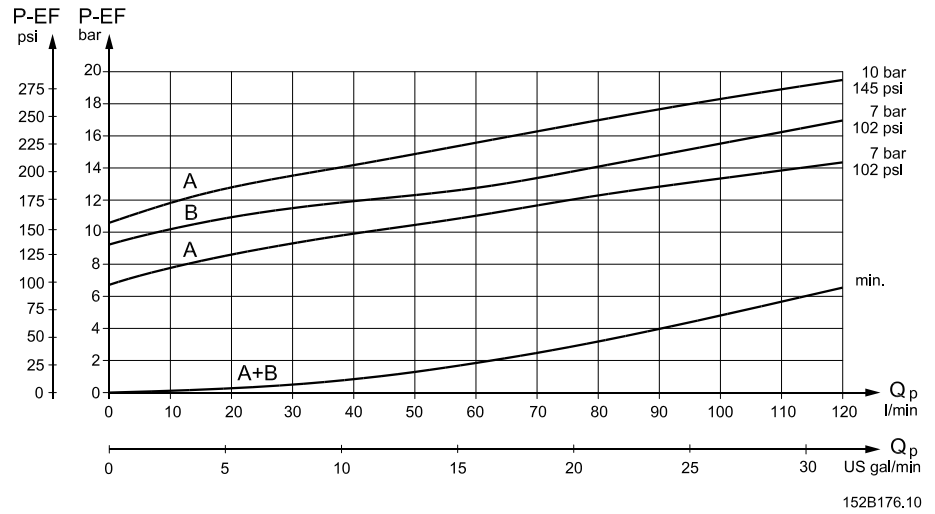

- A: OLS 120 Dynamic for OSPB, OSPC, OSPD, OSPQ, OSPL LS Dynamic
- B: OLS 120 Dynamic for OSPF LS Dynamic

OLS 160

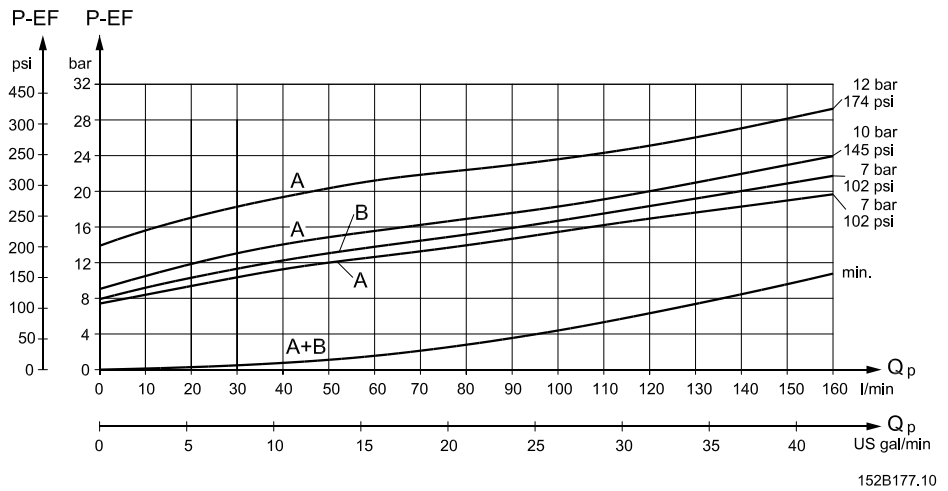

- A: OLS 160 Dynamic for OSPB, OSPC, OSPD, OSPQ, OSPL LS Dynamic
- B: OLS 160 Dynamic for OSPF LS Dynamic

**TECHNICAL DATA**

**Pressure drop P-EF for OLSP static priority valves**

*OLSP 80*

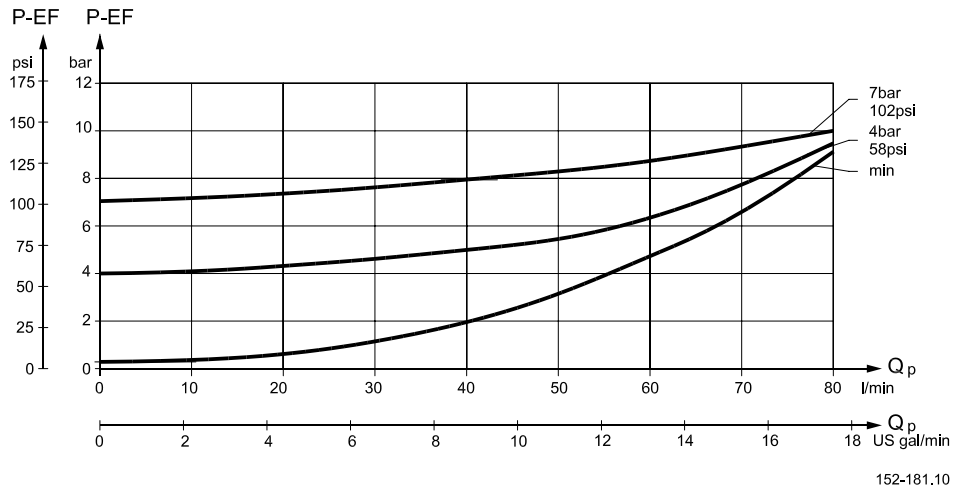

**Pressure drop P-EF for OLSP dynamic priority valves**

*OLSP 80*

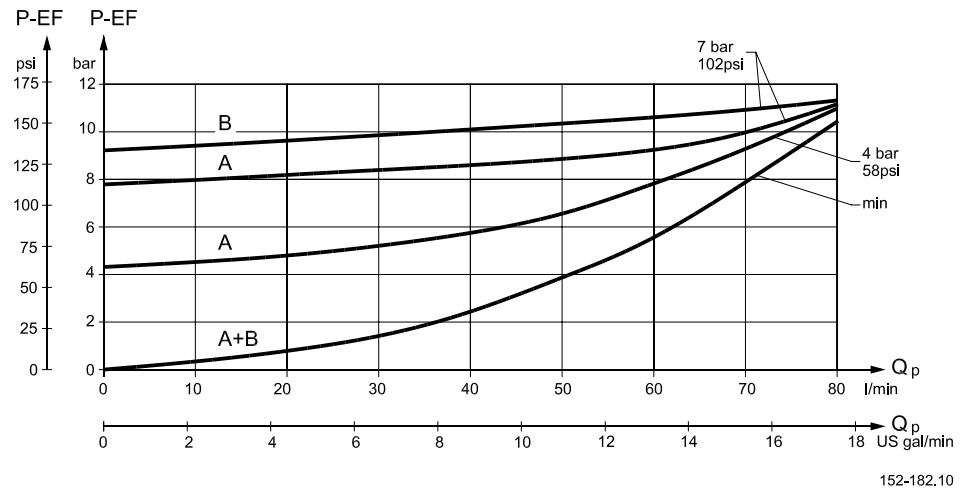

A: OLSP 80 dynamic for OSPB, OSPC, OSPD, OSPQ LS dynamic

B: OLSP 80 dynamic for OSPF LS dynamic



**TECHNICAL DATA**

**Pressure drop P-EF for OLS 320 static priority valves**

OLS 320

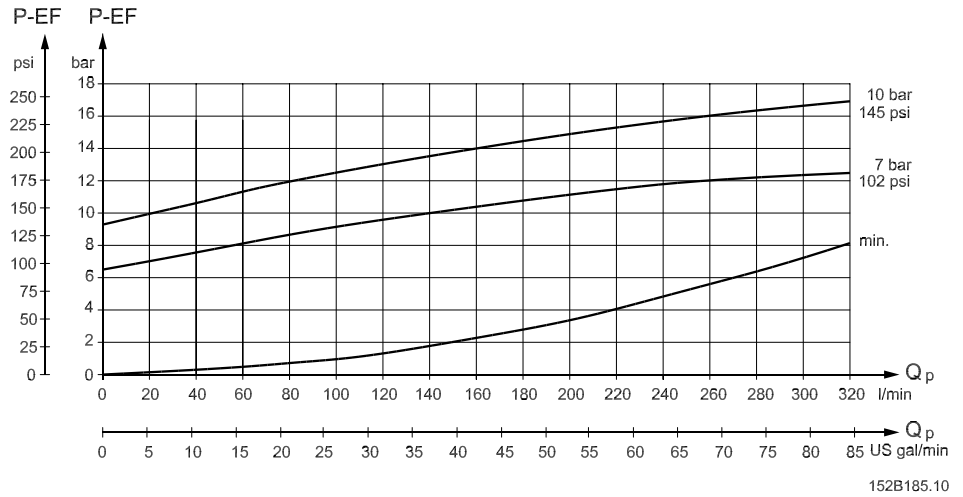

**Pressure drop P-EF for OLS 320 dynamic priority valves**

OLS 320

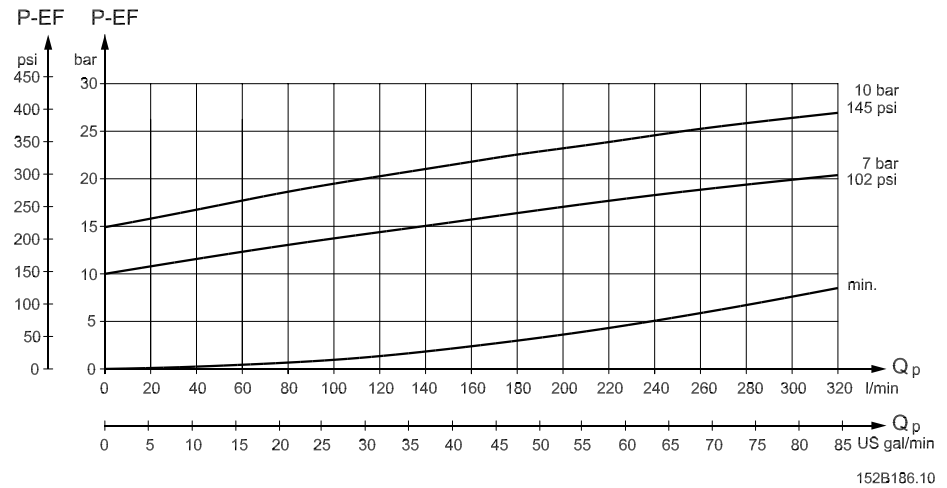

**TECHNICAL DATA**

**OLS 160, pilot pressure relief valve (P - T, Q<sub>p</sub>) characteristic**

OLS 160 with pilot pressure relief valve is used in connection with Sauer-Danfoss steering units without pilot pressure relief valve, normally steering unit type OSPL. The pilot pressure relief valve protects the steering unit against excessive pressure. The pilot pressure relief valve in OLS 160 operates with the priority valve spool in the OLS 160 to limit the maximum steering pressure P-T measured across the steering unit ports. The pilot pressure relief valve is set when an oil flow of 80 l/min [21 US gal/min] is supplied to OLS 160.

Setting tolerance:

< / = 170 bar [ 2466 psi]: rated value +5 bar [72.5 psi]

> 170 bar [2466 psi]: rated value +10 bar [145 psi]

*OLS 160*

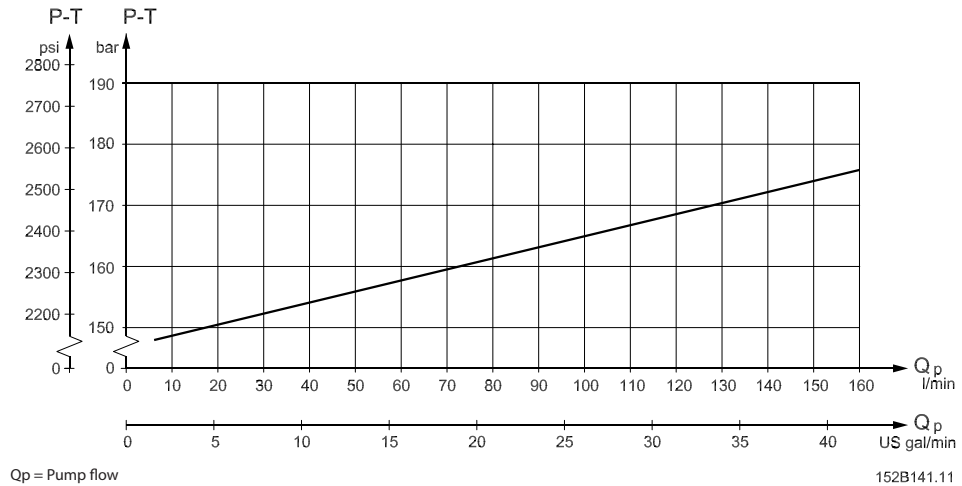

*OLS 320*

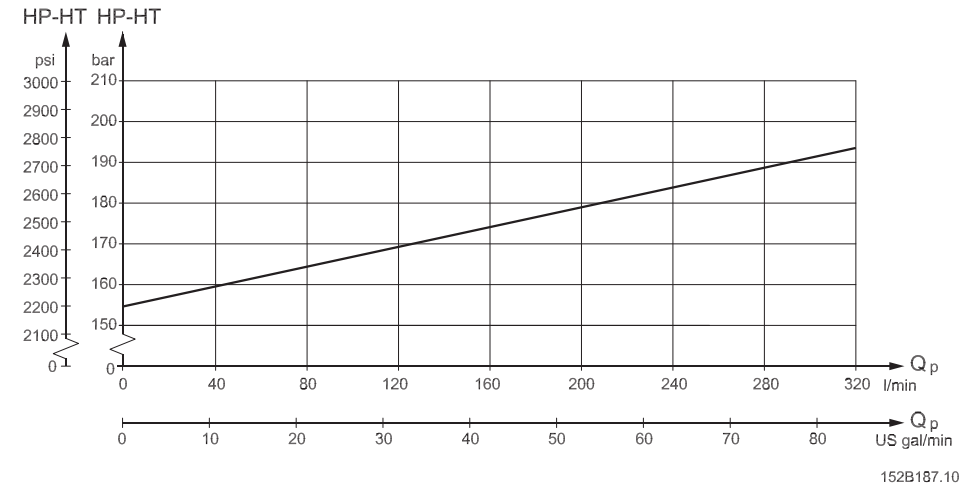

**DIMENSIONS**

*OLSA*

European version:

P, EF:

- G ½ w. spot face
- 14 mm [0.55 in] deep
- x = 34 mm [1.34 in],
- max. 1,5 mm [0.06 in] deep
- or M18 x 1.5 ISO 6149
- 14,5 mm [0.57 in] deep
- x = 29 mm [1.14 in],
- max. 1,5 mm [0.06 in] deep
- or M22 x 1.5 ISO 6149,
- 15,5 mm [0.61 in] deep
- x = 34 mm [1.34 in],
- max. 1,5 mm [0.06 in] deep

T, L, R:

- G ¾ w. spot face
- 12 mm [0.47 in] deep
- y = 34 mm [1.34 in],
- max. 1,5 mm [0.06 in] deep
- or M18 x 1.5 ISO 6149,
- 15 mm [0.59 in] deep
- y = 29 mm [1.14 in],
- max. 1.5 mm [0.06 in] deep

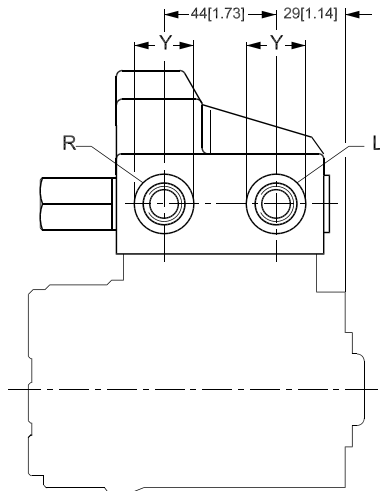

US version:

P, EF:

- 7/8-14 UNF O-ring boss
- 16.7 mm [0.66 in] deep
- x = 34 mm [1.34 in],
- max. 1.5 mm [0.06 in] deep

T, L, R:

- 9/16 - 18 UNF O-ring boss
- 12.7 mm [0.50 in] deep
- y = 25 mm [0.98 in],
- max. 1.5 mm [0.06 in] deep

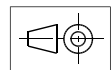
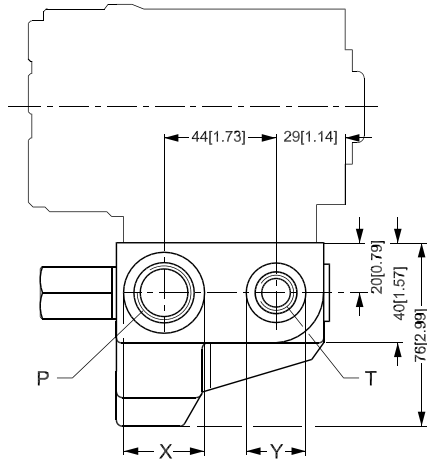
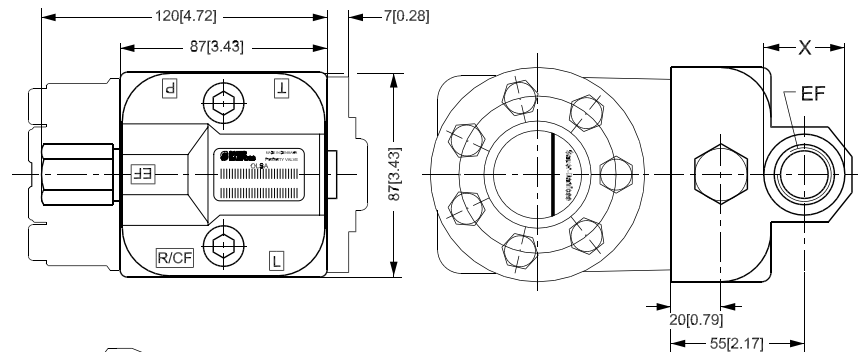

152B81.12

**DIMENSIONS**

OLS 40, OLS 80

European version:

P, EF:

G ½ w. spot face  
 15 mm [0.59 in] deep  
 x = 29 mm [1.14 in],  
 max. 1.5 mm [0.06 in] deep  
 or M22 x 1.5 ISO 6149  
 15 mm [0.59 in] deep,  
 x = 34 mm [1.34 in],  
 max. 1 mm [0.04 in] deep

CF:

G ½ w. spot face  
 14 mm [0.55 in] deep  
 y = 29 mm [1.14 in],  
 max. 1.5 mm [0.06 in] deep  
 or M18 x 1,5 ISO 6149  
 12 mm [0.47 in] deep,  
 y = 29 mm [1.14 in],  
 max. 1 mm [0.04 in] deep

LS:

G ¼ w. spot face  
 12.5 mm [0.49 in] deep  
 z = 21 mm [0.83 in],  
 max. 1 mm [0.04 in] deep  
 or M12 x 1,5 ISO 6149  
 12,5 mm [0.49 in] deep,  
 z = 22 mm [0.86 in]  
 0 mm deep

US version:

P, EF:

7/8 - 14 UNF O-ring boss  
 15 mm [0.59 in] deep  
 x = 34 mm [1.14 in],  
 max. 1.3 [0.05] deep

CF:

¾-16 UNF O-ring boss  
 14,3 mm [0.56 in] deep  
 y = 30 mm [1.18 in],  
 max. 1.3 mm [0.05 in] deep

LS:

7/16-20 UNF O-ring boss  
 12.5 mm [0.49 in] deep  
 z = 21 mm [0.83 in],  
 max. 1 mm [0.04 in] deep

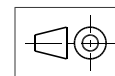
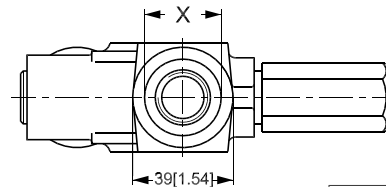
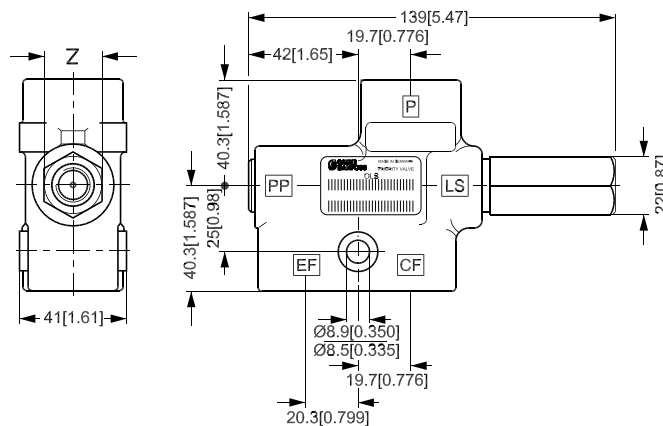
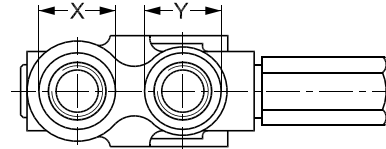

152B136.11

**DIMENSIONS**

*OLS 120*

European version:

P, EF:

G 3/4 w. spot face  
 x = 42 mm [1.65 in],  
 max. 2.5 mm [0.10 in] deep  
 or M27 x 2 ISO 6149  
 x = 40 mm [1.57 in],  
 max. 2.5 mm [0.10 in] deep

CF:

G 1/2 w. spot face  
 y = 34 mm [1.34 in],  
 max. 2.5 mm [0.10 in] deep  
 or M18 x 1.5 ISO 6149  
 y = 29 mm [1.14 in],  
 max. 2.5 mm [0.10 in] deep

LS, PP:

G 1/4 w. spot face  
 12 mm [0.47 in] deep  
 z = 19 mm [0.75 in]  
 0 mm deep  
 or M12 x 1,5 ISO 6149  
 11,5 mm [0.45 in] deep,  
 z = 19 mm [0.75 in]  
 0 mm deep

US version:

P, EF:

1 1/16 - 12 UN O-ring boss  
 x = 41 mm [1.61 in],  
 max. 1.5 mm [0.06 in] deep

CF:

3/4 - 16 UNF O-ring boss  
 y = 30 mm [1.18 in],  
 max. 1.5 mm [0.06 in] deep

LS, PP:

7/16 - 20 UNF O-ring boss  
 11.5 mm [0.45 in] deep  
 z = 19 mm [0.75 in] 0 mm deep

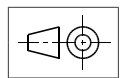
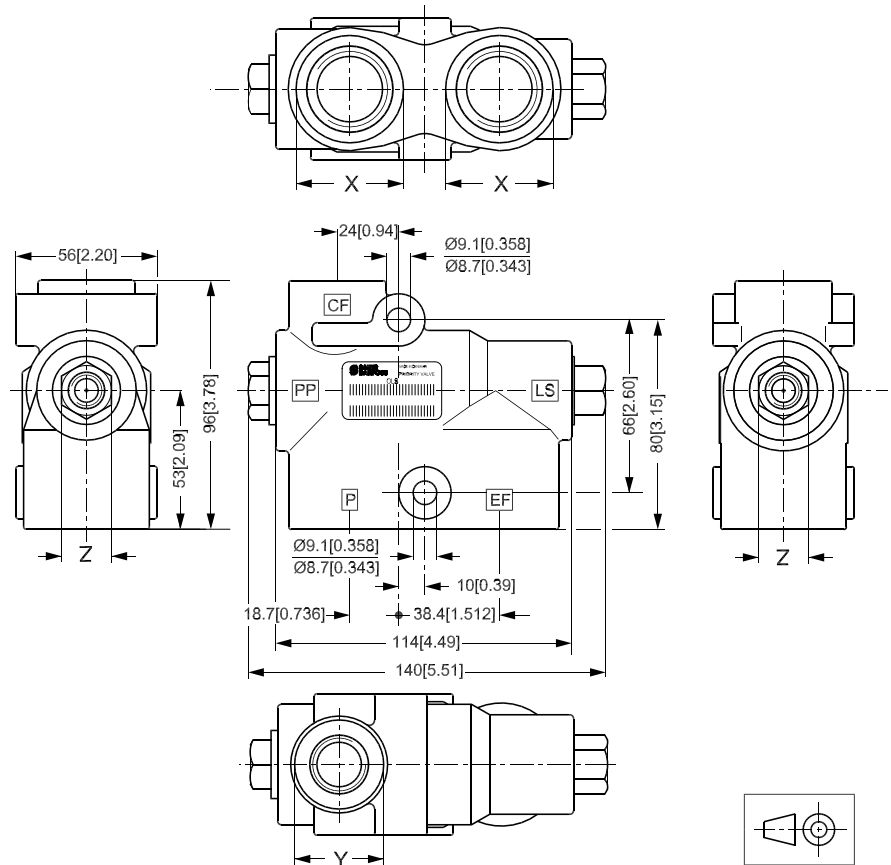

152B173.11



**DIMENSIONS**

*OLSP 80*

European version:

CF:

- G 3/8 w. spot face
- 15 mm [0.59 in] deep
- x =  $\varnothing 28$ , max. 1.5 mm [0.06 in] deep
- or
- M18 • 1.5 ISO 6149
- 15 mm [0.59 in] deep
- y =  $\varnothing 29$ , max. 1.5 mm [0.06 in]

EF:

- G 1/2 w. spot face
- 15 mm [0.59 in] deep
- y =  $\varnothing 34$ , max. 1.5 mm [0.06 in]
- or
- M22 • 1.5 ISO 6149
- 15 mm [0.59 in] deep
- x =  $\varnothing 34$ , max. 1.5 mm [0.06 in]

LS:

- G 1/4 w. spot face
- 12.5 mm [0.49 in] deep
- or
- M12 • 1.5 ISO 6149
- 12.5 mm [0.49 in] deep

US version:

CF:

- 3/4-16 UNF O-ring boss
- 15 mm [0.59 in] deep
- x =  $\varnothing 29$  [1.14 in]
- max. 1.5 mm [0.06 in] deep

EF:

- 7/8 - 14 UNF O-ring boss
- 16.7 mm [0.66 in] deep
- y =  $\varnothing 34$  [1.34 in]
- max. 1.5 mm [0.06 in] deep

LS:

- 7/16 - 20 UNF O-ring boss
- 12.5 mm [0.49 in] deep

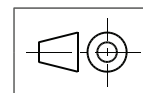
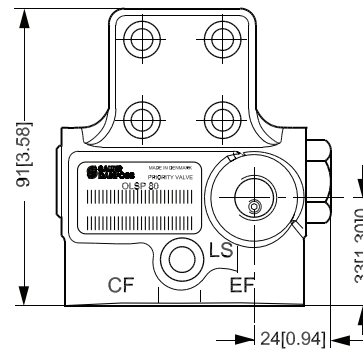
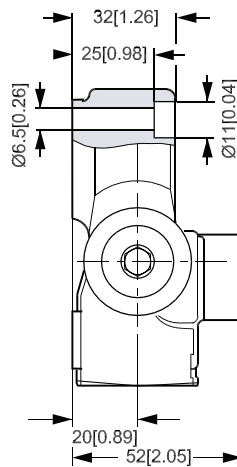
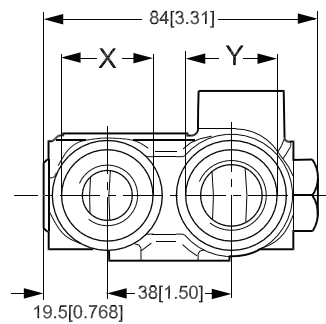
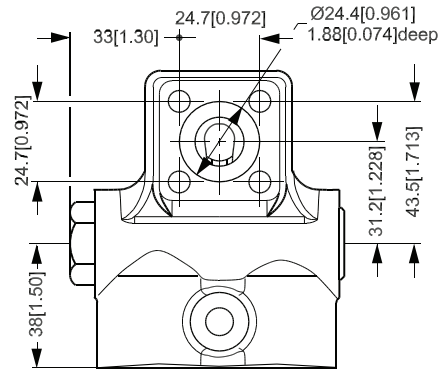

152-180.11

**DIMENSIONS**

*OLS 320 in-line*

European version:

P,EF:

- G 1 w. spot face
- x =  $\varnothing 47$  mm [1.85 in]
- max 1 mm [0.04 in] deep

CF:

- G ½ w. spot face
- y =  $\varnothing 34$  mm [1.34 in]
- max 2.5 mm [0.10 in] deep

LS,PP:

- G ¼ w. spot face

T:

- G ¼ w. spot face
- z =  $\varnothing 25$  mm [0.98 in]
- max 1.5 mm [0.06 in] deep

US version:

P,EF:

- 1 5/16-12 UN O-ring boss
- x =  $\varnothing 49$  mm [1.93 in]
- max 0.2 mm [0.01 in] deep

CF:

- 1 1/16-12 UN O-ring boss
- y =  $\varnothing 41$  mm [1.61 in]
- max 0.2 mm [0.01 in] deep
- or
- ¾-16UNF O-ring boss
- y =  $\varnothing 30$  mm [1.18 in]
- max 0.2 mm [0.01 in] deep

LS,PP,T:

- 7/16-20 UNF O-ring boss

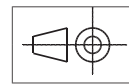
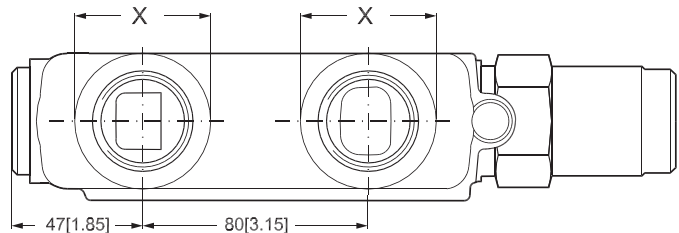
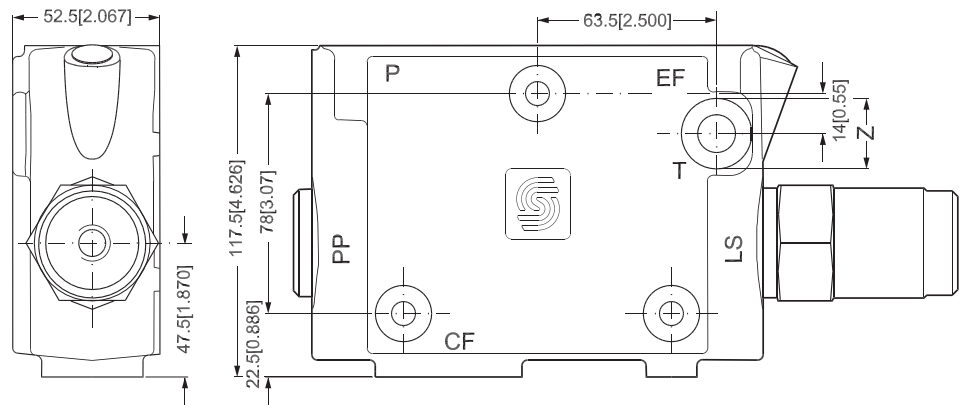
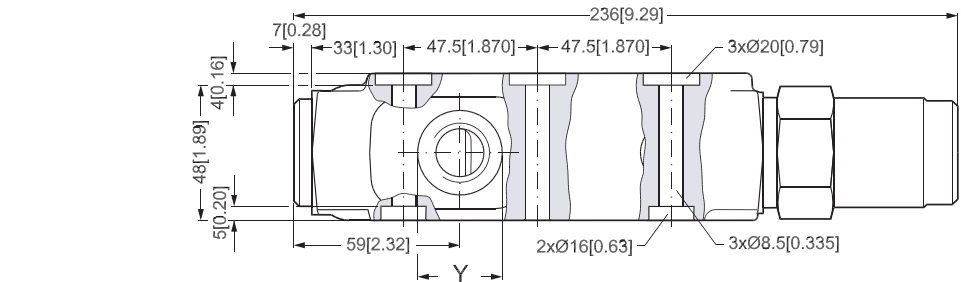

150H26.10



**VERSIONS**

**OSQA and OSQB static**

Flow amplifier OSQ is used in steering systems of large vehicles and vessels that need high oil flow for their steering. A steering system of this nature consists of a steering unit and a flow amplifier.

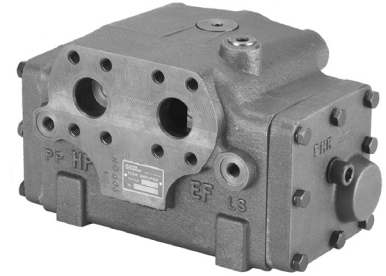

F300630

*OSQA static*

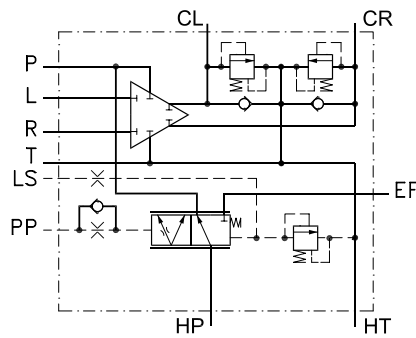

150F56.10

*OSQB static*

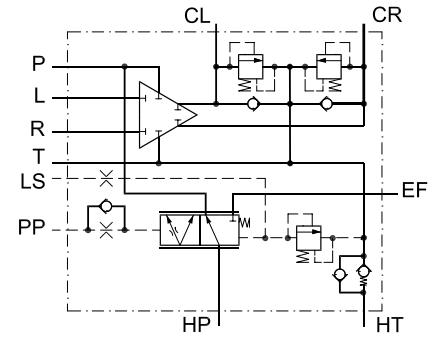

150F55.10

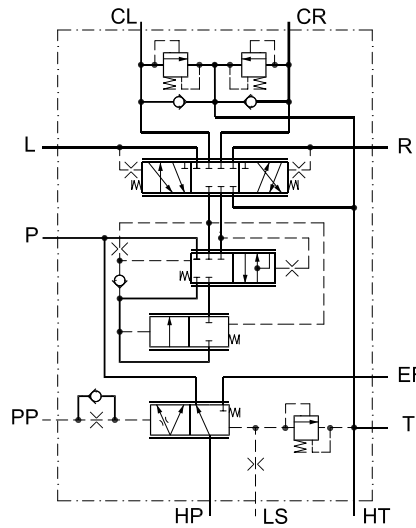

150F69.10

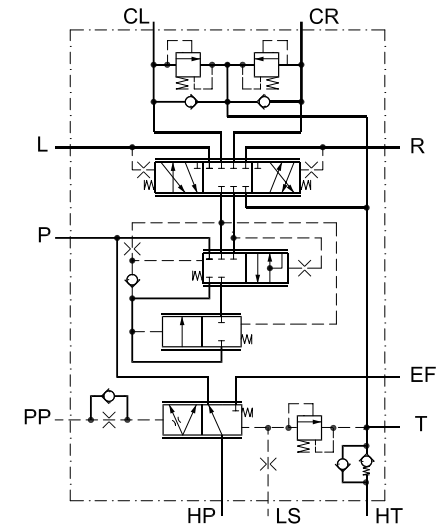

150F54.10

**VERSIONS**

**OSQB dynamic with OLSQ priority  
 valve for emergency steering**



F301256

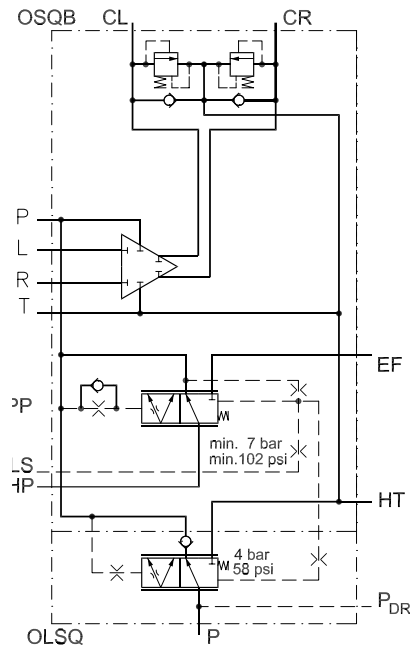

150F74.11

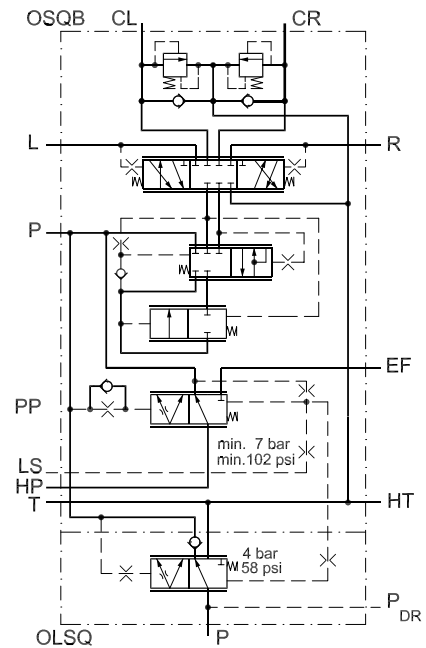

150F73.11

**CODE NUMBERS AND WEIGHTS**

**OSQA and OSQB static flow amplifiers for load sensing static steering units**

These flow amplifiers have to be used in connection with steering units type OSPBX LS or OSPLX LS.

Flow amplifier	Code Numbers		Setting pressures		Control spring pressure bar [psi]	Weight kg [lb]
	Connections: see "dimensions"		Pilot pressure relief valve bar [psi]	Shock valves bar [psi]		
	European version	US version				
OSQA 4	150F0040	150F0043	170 [2465]	230 [3335]	7 [101]	29 [64]
OSQA 5	150F0041	150F0044	170 [2465]	230 [3335]	7 [101]	29 [64]
OSQA 8	150F0042	150F0045	170 [2465]	230 [3335]	7 [101]	29 [64]
OSQB 4	150F0030	150F0053	170 [2465]	230 [3335]	7 [101]	29 [64]
OSQB 5	150F0031	150F0054	170 [2465]	230 [3335]	7 [101]	29 [64]
OSQB 8	150F0032	150F0055	170 [2465]	230 [3335]	7 [101]	29 [64]
OSQB 10	-	150F0094	170 [2465]	260 [3770]	7 [101]	29 [64]

**OSQB/OLSQ dynamic flow amplifier for load sensing dynamics steering units.**

OSQB with OLSQ has no pilot pressure relief valve.

This flow amplifier has to be used in connection with steering unit type OSPCX LS, which has incorporated pilot pressure relief valve

Flow amplifier	Code Numbers		Setting pressures		Control spring pressure		Weight	
	Connections see "dimensions" European version		Shockvalves		bar [psi]		kg [lb]	
	bar	[psi]	bar	[psi]	bar	[psi]	kg	[lb]
OSQB 8/OLSQ	150F8010	260	[3770 psi]	7	[101.5]	32	[70.6]	

If you require other amplification factors, other valve settings or other control spring pressures, please fill in the order form on page 68 and contact the Sauer-Danfoss Sales Organization.

**SPECIFICATION TABLE FOR NON CATALOGUE NUMBERS OF SAUER-DANFOSS FLOW AMPLIFIERS**

Fill in your company data and place x's in the table where appropriate, then send to your Sauer-Danfoss Sales Organization

Your company	Name	Vehicle	Potential pcs/year	Completed by	Date	
Your application	Pump flow to OSQ at idle, l/min [US gal/min]		Pump flow to OSQ at max engine speed, l/min [US gal/min]			
Flow amplifier type	OSQA	OSQB	OSQB/OLSQ			
Amplification factor	4	5	8	9.1	16.5	
Load sensing type	Static		Dynamic			
Control spring bar	7 [101]	10 [145]		16 [232]		
PP-connection	Internal		External			
Ports, OSQA	G: European version HP, EF, HT, CL, CL: G 3/4 P, T, L, R: G 1/2 PP, LS: G 1/4		UNF: US version HP, EF, HT, CL, CR: 1 1/16 - 12 UN P, T, L, R: 3/4 - 16 UNF PP, LS: 7/16 - 20 UNF			
Ports, OSQB	G: European version HP, EF: 1 1/4 in SAE flange HT, CL, CR: 1 in SAE flange P, T, L, R: G 1/2 PP, LS: G 1/4		UNF: US version HP, EF: 1 1/4 in SAE flange HT, CL, CR: 1 in SAE flange P, T, L, R: 3/4 - 16 UNF PP, LS: 7/16 - 20 UNF			
Ports, OSQB/OLSQ	G: (European version) HP, EF: 1 1/4 in SAE flange HT, CL, CR: 1 in SAE flange P <sub>OSQ</sub> , P <sub>OLSQ</sub> , T, L, R: G 1/2 PP, LS: G 1/4					
Pilot pressure relief valve bar [psi]	100 [1450]	120 [1740]	140 [2030]	170 [2465]	210 [3045]	No relief valve (only OSQB/OLSQ)
Shock valves, bar [psi]	165 [2393]	200 [2900]	230 [3335]	260 [3770]	270 [3916]	
Back pressure valve	Yes (Only OSQB)			No		
Unit black painted	Yes			No		

An alternative way to specify a variant is to state an existing code number and add the modifications, you would like to have implemented in the basic flow amplifier.

Code number of basic flow amplifier: \_\_\_\_\_  
 Requested modifications: \_\_\_\_\_

**TECHNICAL DATA**

**Flow and pressure**

Flow amplifier	Rated flow to HP-connection l/min [US gal/min]		Max. pressure on connections							
			HP, EF, CL CR		CF, LS, PP		HT		T	
			bar	[psi]	bar	[psi]	bar	[psi]	bar	[psi]
OSQA	240	[63.4]	280	[4061]	210	[3045]	15	[217.5]	15	[217.5]
OSQB	400	[106]	280	[4061]	210	[3045]	10	[145]	15	[217.5]

**Total displacement of steering system**

Flow amplifier	Amplification factor	Steering unit						
		OSPBX/OSPCX LS				OSPLX LS		
		160	200	315	400	520	630	800
		cm <sup>3</sup> /rev [in <sup>3</sup> /rev]	cm <sup>3</sup> /rev [in <sup>3</sup> /rev]	cm <sup>3</sup> /rev [in <sup>3</sup> /rev]	cm <sup>3</sup> /rev [in <sup>3</sup> /rev]	cm <sup>3</sup> /rev [in <sup>3</sup> /rev]	cm <sup>3</sup> /rev [in <sup>3</sup> /rev]	cm <sup>3</sup> /rev [in <sup>3</sup> /rev]
OSQA 4	4	640 [39]	800 [49]	1260 [77]	1600 [98]	2080 [127]		
OSQA 5	5	800 [49]	1000 [61]	1575 [96]	2000 [122]			
OSQA 8	8	1280 [78]	1600 [98]					
OSQA 10	9.1	1456 [89]						
OSQB 4	4					2080 [127]	2520 [154]	3200 [195]
OSQB 5	5				2000 [122]	2600 [159]	3150 [192]	4000 [244]
OSQB 8	8			2520 [154]	3200 [195]	4160 [254]		
OSQB 10	9.1		1820 [111]	2865 [175]	3640 [222]			
OSQB 20	16.5	2640 [161]	3300 [201]					

**Installation**

*The flow amplifier has to be mounted on a flat surface.*

Mounting screw	Tightening torque, Nm [lbf·in]
M 10 x 1.5	30 +/- 5 [265 +/- 44]
<sup>3</sup> / <sub>8</sub> - 16 UNC	40 +/- 5 [354 +/- 44]
<sup>7</sup> / <sub>16</sub> - 14 UNC	55 +/- 5 [487 +/- 44]

Tightening torque for fittings: Look in sub catalogue "General Steering Components" page 36.

**TECHNICAL DATA**

**Valve functions in the flow amplifiers**

The datas below come from measurements on a representative sample of flow amplifiers from production. Oil with viscosity of 21 mm<sup>2</sup>/s [102 SUS] at 50 °C [122 °C] was used during measuring.

**Priority valve**

The priority valve is used in load sensing systems where the same pump supplies oil to both the steering system and working hydraulics. The steering system always has first priority. Measurements were made when the pressure on the LS connection is zero. (steering unit is in neutral position). The minimum curves apply when the pressure on the EF connection is higher than the actual control spring pressure. The curves for control spring pressure of 7 bar [101.5 psi] apply when the pressure on the EF connection is zero

**OSQA**

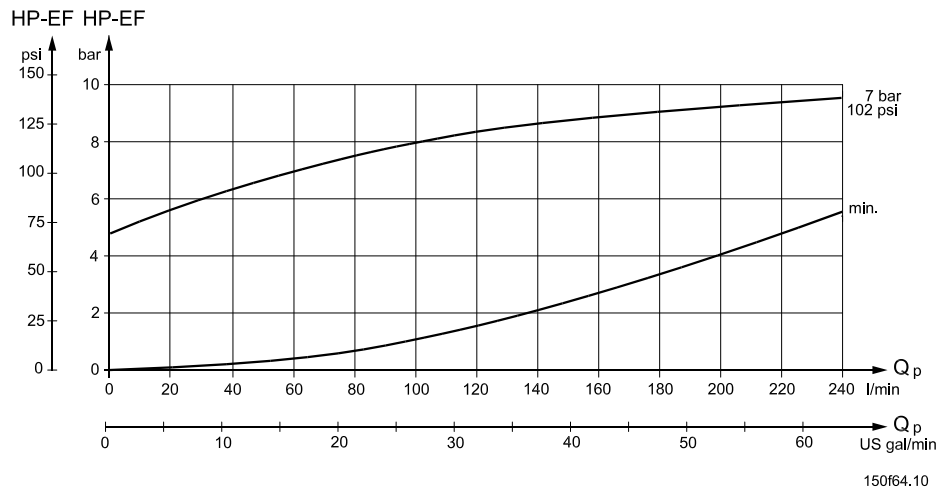

**OSQB**

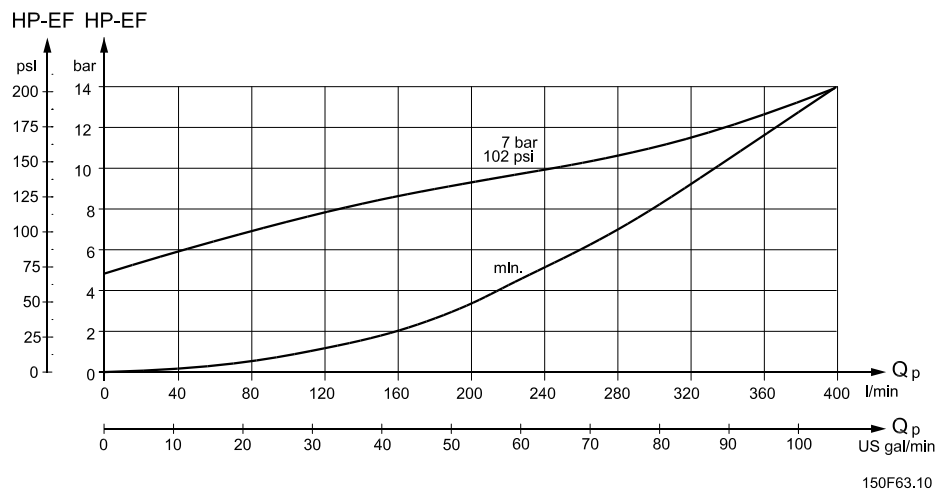

**TECHNICAL DATA**

**OSQ pilot pressure relief valve  
 (HP - HT, Q<sub>p</sub>) characteristic**

The pilot pressure relief valve protects the steering unit against excessive pressure. The pilot pressure relief valve together with the priority valve limit the maximum steering pressure HP-HT.

The pilot pressure relief valve in OSQ is set with an oil flow of 140 l/min [37 US gal/min] supplied to the HP connection.

Setting tolerance: rated value +10 bar [+145 psi]. The curves below are valid for rated settings 170 bar [2466 psi].

**OSQA**

HP-HT HP-HT

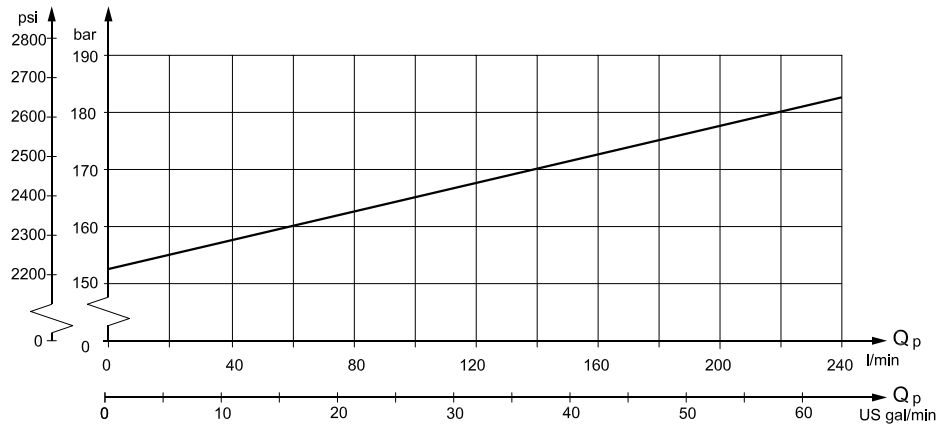

150F67.10

**OSQB**

HP-HT HP-HT

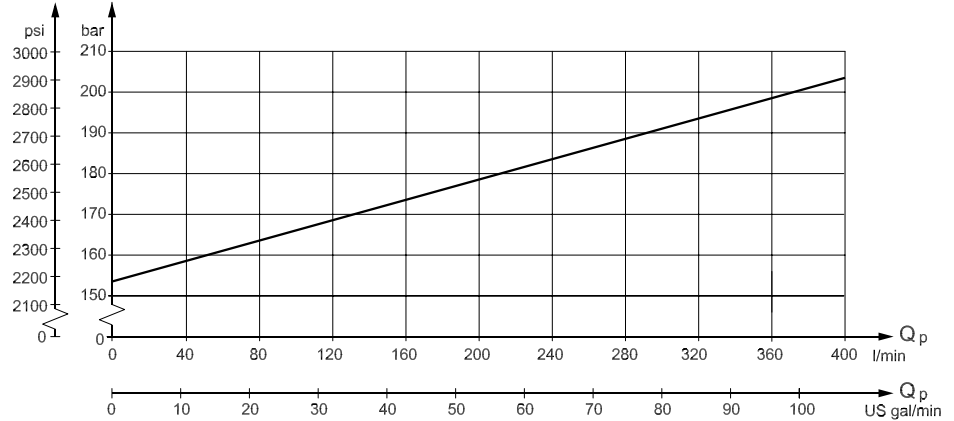

150F66.11

**TECHNICAL DATA**

**Back pressure valve**

The back pressure valve in (OSQB only) increases the capacity of the suction valves. The pressure drop shown applies to the back pressure valve only.

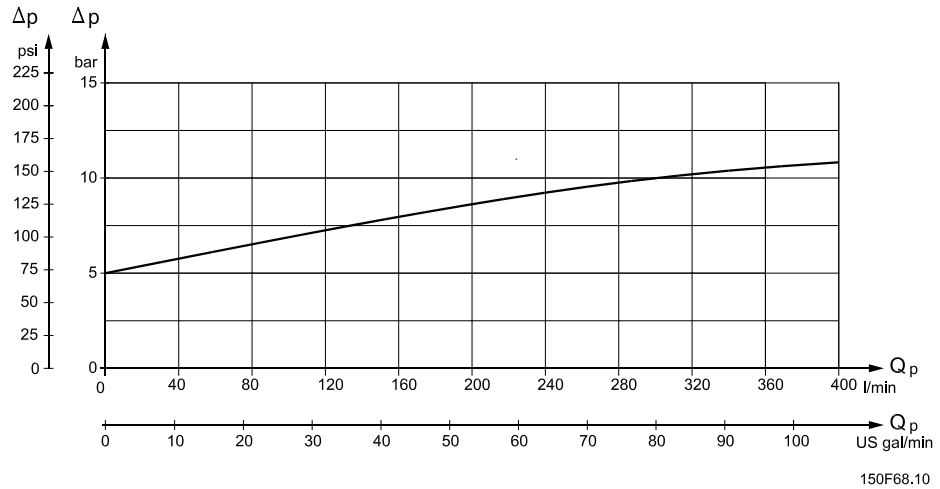

**Shock valves**

The shock valves protect the flow amplifier against shock from external forces on the steering cylinders. The shock valves in OSQA and OSQB limit the maximum pressure drop from CL to HT and from CR to HT. The shock valves are set at 10 l/min [2.64 US gal/min]. Setting tolerance: rated value +20 bar [290 psi].

**Suction valves**

The suction valves ensure oil suction on the side of the steering cylinder pistons where in unfavorable conditions cavitation might occur. The capacity of the suction valves is increased in OSQB by the built-in back pressure valve.

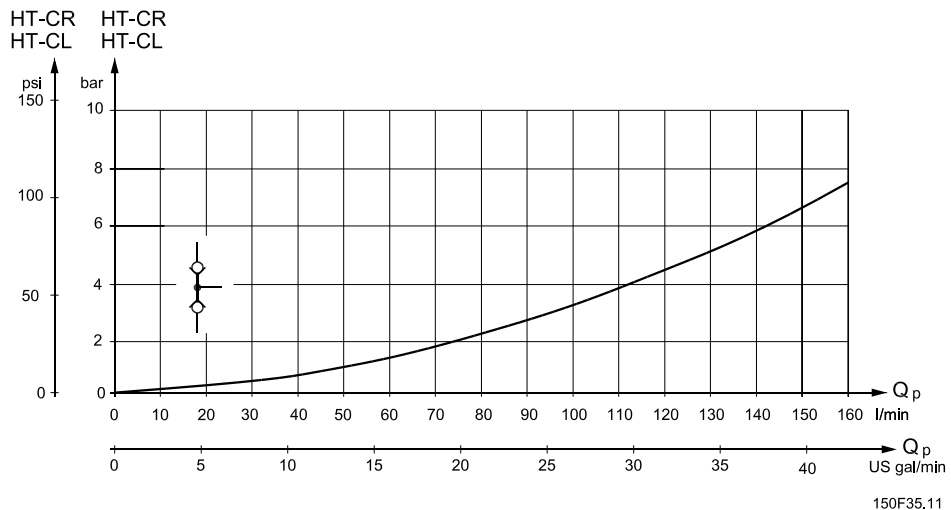



**TECHNICAL DATA**

**Priority valve OLSQ for emergency circuit in OSQB/OLSQ**

When under normal steering conditions the stand-by pressure in the main circuit (minimum 7 bar [101.5 psi] priority valve spring in OSQ) overrules the spring pressure in OLSQ (4 bar [58 psi] spring), OLSQ's priority valve will pass oil from the emergency steering pump across OLSQ's P-connection to the flow amplifier's HT tank connection. If the oil supply from the main pump should fail, the stand-by pressure of OSQ's priority valve in the main pump circuit disappears and relocates the spool in OLSQ to enable the oil from the emergency steering pump to enter the pump circuit in the OSQ. The curve shows the pressure drop from OLSQ's P-connection to OLSQ's HT-connection with an active main pump and neutral positioned steering. The curve solely applies to OSQs without any back pressure valve in the tank line.

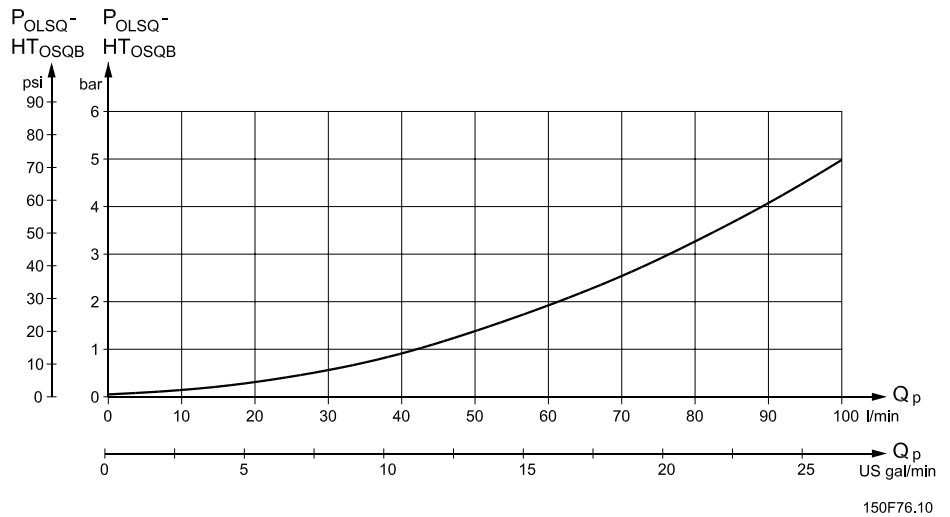

**DIMENSIONS OSQA**

European version:

- HP, EF, HT, CL, CR: G 3/4
- P, T, L, R: G 1/2
- PP, LS: G 1/4

A: M10 x 1.5, 21 mm [0.83 in] deep  
 B: M10 x 1.5, 16 mm [0.63 in] deep

US version:

- HP, EF, HT, CL, CR: 1 1/16 - 12 UN
- P, T, L, R: 3/4 - 16 UNF
- PP, LS: 7/16 - 20 UNF

A: 7/16 - 14 UNC, 21 mm [0.83 in] deep  
 B: 7/16 - 14 UNC, 16 mm [0.63 in] deep

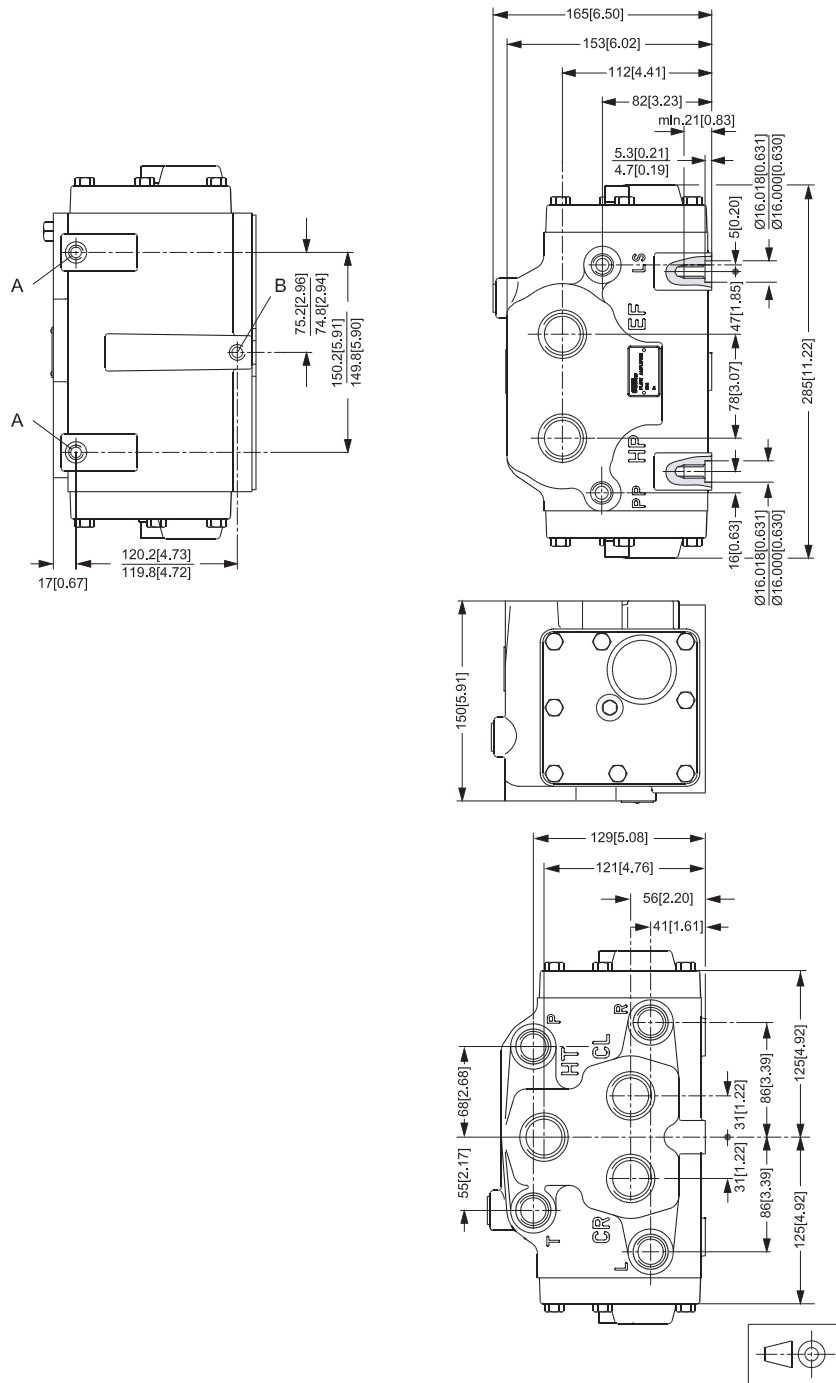

150F36.11

**DIMENSIONS OSQB**

European version:  
 HP, EF:  
 1 ¼ in SAE flange  
 7/16 - 14 UNC  
 18 mm [0.71 in] deep (8)

HT, CL, CR:  
 1 in SAE flange  
 3/8 - 16 UNC  
 18 mm [0.71 in] deep (12)

P, T, L, R: G ½  
 PP, LS: G ¼

A: M10 x 1,5, 21 mm [0.83 in] deep  
 B: M10 x 1,5, 16 mm [0.63 in] deep

US version:  
 HP, EF:  
 1 ¼ in SAE flange  
 7/16 - 14 UNC  
 18 mm [0.71 in] deep (8)

HT, CL, CR:  
 1 in SAE flange  
 3/8 - 16 UNC  
 18 mm [0.71 in] deep (12)

P, T, L, R: ¾ - 16 UNF  
 PP, LS: 7/16 - 20 UNF

A:  
 7/16 - 14 UNC, 21 mm [0.83 in] deep  
 B:  
 7/16 - 14 UNC, 16 mm [0.63 in] deep

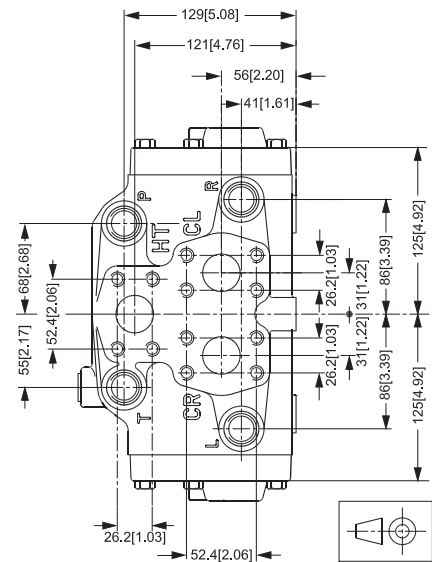
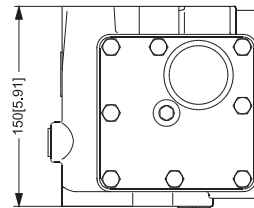
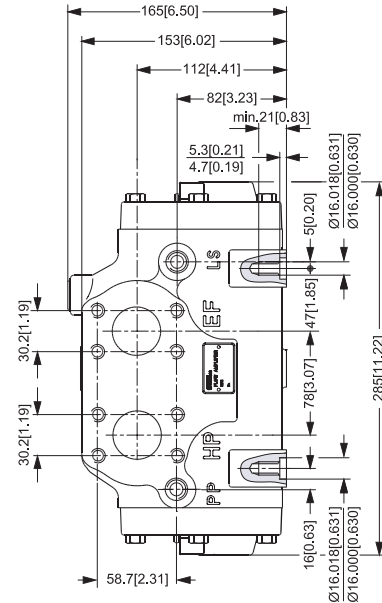
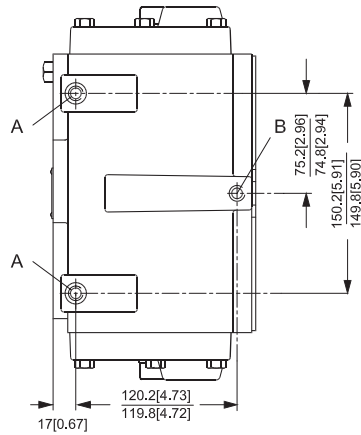

150F37.10

**DIMENSIONS**  
**OSQB WITH OLSQ**

European version  
 HP, EF:  
 1 ¼ in SAE flange  
 7/16 - 14 UNC  
 18 mm [0.71 in] deep (8)

HT, CL, CR:  
 1 in SAE flange  
 ¾ - 16 UNC  
 18 mm [0.71 in] deep (12)

P<sub>OSQ</sub>, P<sub>OLSQ</sub>, T, L, R: G ½  
 PP, LS, P<sub>DR</sub>: G ¼

A:  
 M10 x 1.5, 21 mm [0.83 in] deep  
 B:  
 M10 x 1.5, 16 mm [0.63 in] deep

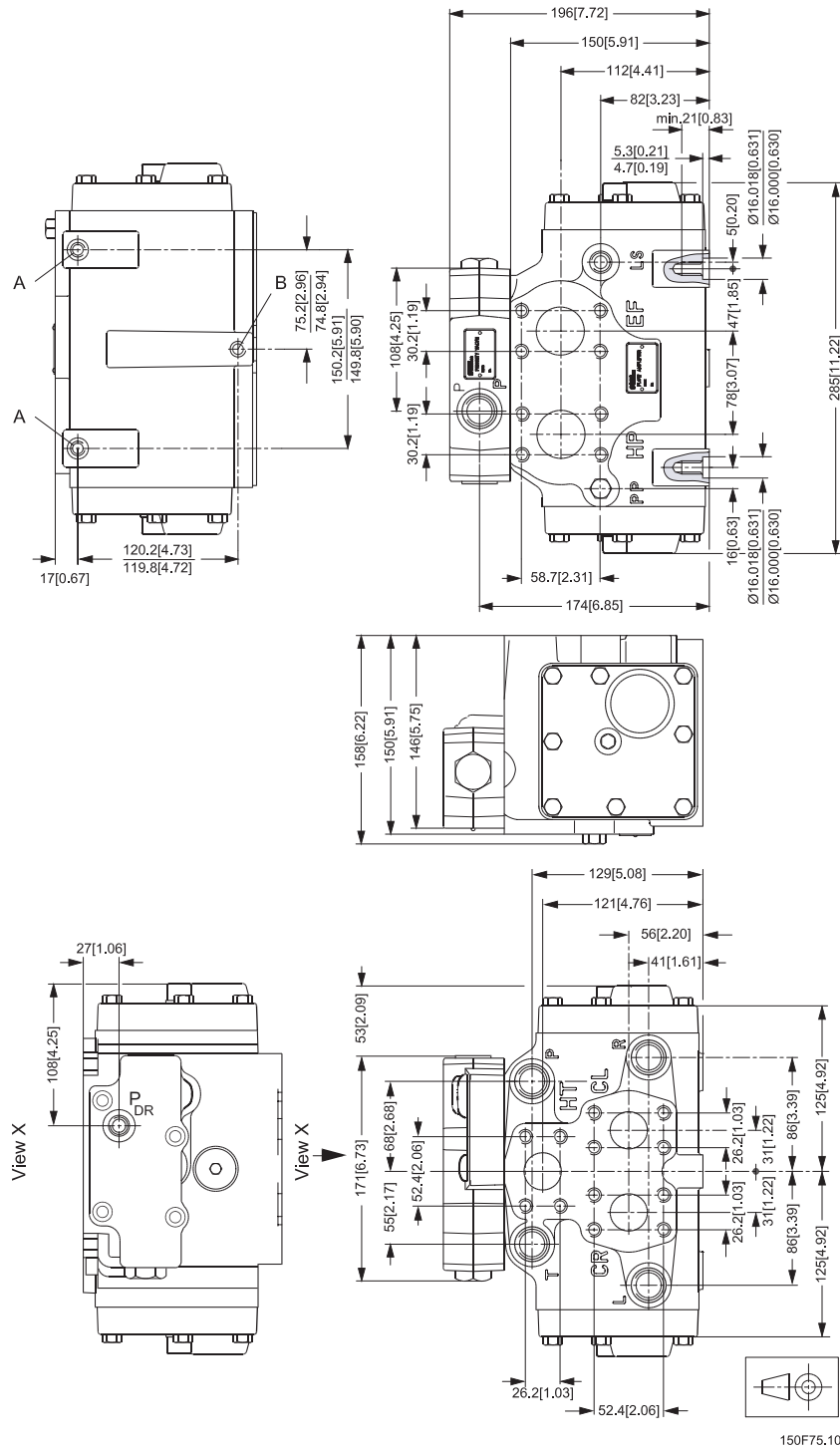

150F75.10



Load Sensing Steering units, Priority valves and Flow amplifiers  
Technical Information  
Notes



Load Sensing Steering units, Priority valves and Flow amplifiers  
Technical Information  
Notes



Load Sensing Steering units, Priority valves and Flow amplifiers  
Technical Information  
Notes

## OUR PRODUCTS

Hydrostatic transmissions  
Hydraulic power steering  
Electro-hydraulic power steering  
Electric power steering  
Closed and open circuit axial piston pumps and motors  
Gear pumps and motors  
Bent axis motors  
Orbital motors  
Transit mixer drives  
Planetary compact gears  
Proportional valves  
Directional spool valves  
Cartridge valves  
Hydraulic integrated circuits  
Hydrostatic transaxles  
Integrated systems  
Fan drive systems  
Electrohydraulics  
Micro-controllers and software  
Electric motors and inverters  
Digital electronics and software  
Joystick and control handles  
Displays  
Sensors

## Sauer-Danfoss Mobile Power and Control Systems – Market Leaders Worldwide

Sauer-Danfoss is a comprehensive supplier providing complete systems to the global mobile market.

Sauer-Danfoss serves markets such as agriculture, construction, road building, material handling, municipal, forestry, turf care, and many others.

We offer our customers optimum solutions for their needs and develop new products and systems in close cooperation and partnership with them.

Sauer-Danfoss specializes in integrating a full range of system components to provide vehicle designers with the most advanced total system design.

Sauer-Danfoss provides comprehensive worldwide service for its products through an extensive network of Global Service Partners strategically located in all parts of the world.

Sauer-Danfoss (US) Company  
2800 East 13th Street  
Ames, IA 50010, USA  
Phone: +1 515 239-6000  
Fax: +1 515 239 6618

Sauer-Danfoss GmbH & Co. OHG  
Postfach 2460, D-24531 Neumünster  
Krokamp 35, D-24539 Neumünster, Germany  
Phone: +49 4321 871-0  
Fax: +49 4321 871 122

Sauer-Danfoss ApS  
DK-6430 Nordborg, Denmark  
Phone: +45 7488 4444  
Fax: +45 7488 4400

Sauer-Danfoss-Daikin LTD  
Sannomiya Grand Bldg. 8F  
2-2-21 Isogami-dori, Chuo-ku  
Kobe, Hyogo 651-0086, Japan  
Phone: +81 78 231 5001  
Fax: +81 78 231 5004