

MORE POWER & NO NOISE THE GREEN SOLUTION

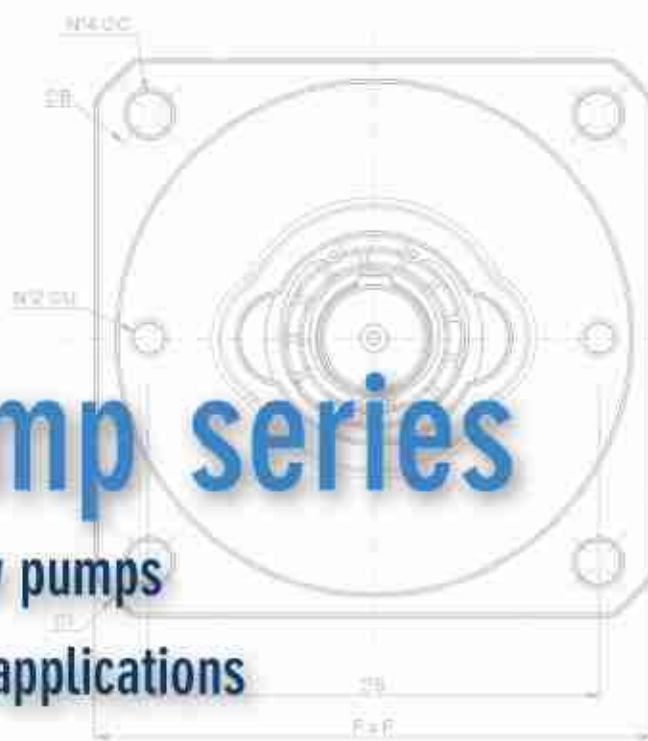

SM pump series

Submersible screw pumps
for lift & elevator applications



LIFT



ELEVATOR



SUBMERSIBLE APPLICATION

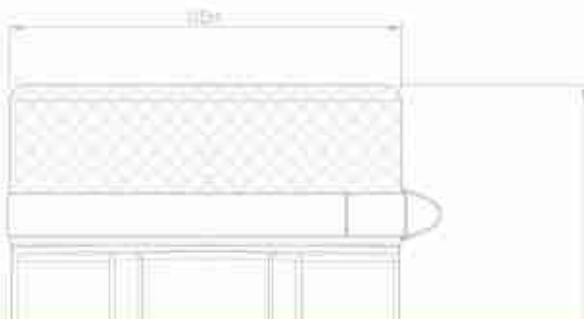



SM pumps are three screw pumps for industrial use at low and medium pressure (80 bar).



Le **SM** sono pompe a tre viti per uso industriale a bassa e media pressione (80 bar).

SM pumps represent a reliable and low noise instrument for applications where a long life pump at low cost is required such as home lift and elevator.

SM pump is a priming pump assembled into a pump body. The three screws rotate inside the pump body and the design of the screws avoids any axial load. The functional pressure develops some tolerances between the balancing piston of the main screw and the surrounding body.

This creates a balancing hydrodynamic force on the screws and at the same time lubricates and cools down the sealing parts. The torque needed to move the lateral screws is transmitted hydraulically by the pumped fluid. This means that the screws rotate with no possibility of wearing.

The high quality of screws manufacturing ensures a very low level of acoustic emissions and pulsation. The geometric design of the three screws creates sealing chambers. During the rotation of the screws, the main one creates a sort of cavity that holds the fluid and drives it with an axial direction from the inlet to the outlet port.

MOTORS:

Motors can be submersible or dry. Immersion type motors are three-phase A.C. or single phase asynchronous motors directly connected to the pump, or with bellhouse and coupling. Enclosure IP 00, form of construction B15, insulation class F. The oil temperature should not exceed 70°C. Protection of the motor and the oil against thermal overloading.

Le pompe **SM** sono componenti affidabili e a basso rumore per applicazioni dove è richiesta una pompa con un tempo di vita lungo e a basso costo, come nel settore degli ascensori.

SM è una pompa del tipo a tre viti, singola voluta, autoadescante volumetrica per basse e medie pressioni. Le tre viti ruotano all'interno del corpo pompa e la progettazione delle viti è fatta per evitare qualsiasi carico assiale. A seconda della pressione di funzionamento, si sviluppa una certa tolleranza tra il pistone di bilanciamento della vite e il corpo principale circostante. Questo crea una forza idrodinamica di bilanciamento delle viti e al tempo stesso lubrifica e raffredda le parti di tenuta. La coppia necessaria per muovere le viti laterali è trasmessa idraulicamente dal fluido pompato. Ciò significa che le viti ruotano senza possibilità di usura.

L'alta qualità della produzione delle viti assicura un bassissimo livello di emissioni acustiche e di pulsazione. Il disegno geometrico delle tre viti di tenuta crea camere di tenuta. Durante la rotazione delle viti, la principale crea una sorta di cavità che contiene il fluido e lo spinge con direzione assiale dal condotto di ingresso a quello di uscita.

MOTORI:

I motori possono essere motori sommersi o esterni. I motori di tipo a immersione sono motori a corrente alternata asincroni trifase o monofase, collegati direttamente alla pompa, o attraverso giunto e lanterna. Grado di protezione IP 00, forma di costruzione B15, isolamento in classe F. La temperatura dell'olio non deve superare i 70 °C.

SM Pumps Series should be used as submersible pumps: horizontal installation (Pic. 1), vertical installation (Pic. 2) and/or semi-submersible (Pic. 3), all with no shaft sealing and with no maintenance. For different installation please contact Settima.

Le pompe **serie SM** sono utilizzate sommerse in posizione orizzontale (Fig. 1), verticale (Fig. 2) e/o semi-sommerse (Fig. 3). Per installazioni differenti si prega di contattare Settima.

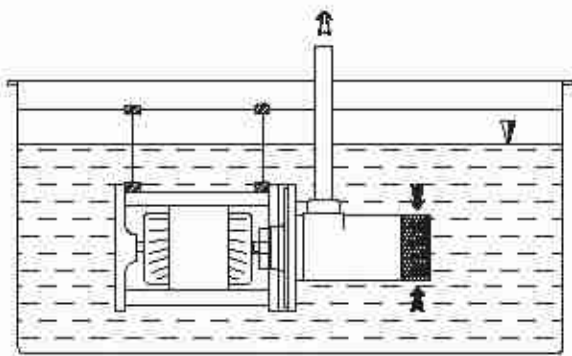

Pic./Fig. 1

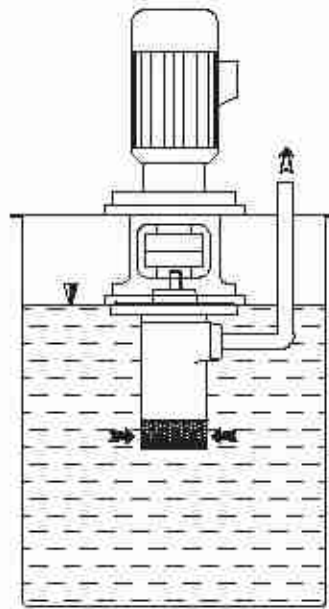

Pic./Fig. 2

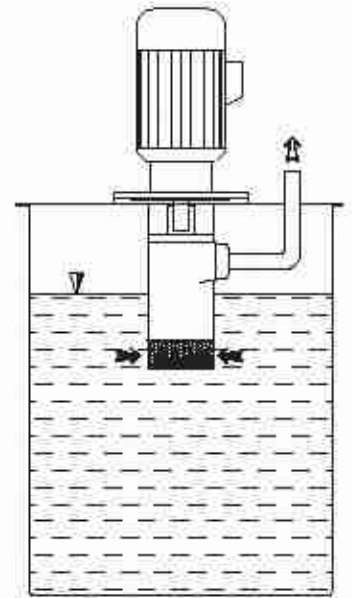

Pic./Fig.3



LIFT / ASCENSORI

Motor pump submersed
 Dry motor + submersed pump
 Dry motor + semi submersed pump
 Motore pompa sommerso
 Motore esterno + pompa sommersa
 Motore esterno + pompa semi sommersa

Offices / Uffici

Hospitals / Strutture ospedaliere

Hotels / Alberghi

Shopping centres / Centri commerciali

Industrial / Industriale

Heavy duty / Alta pressione

**ELEVATOR / ELEVAZIONE**

Motor pump submersed
 Dry motor + submersed pump
 Dry motor + semi submersed pump
 Motore pompa sommerso
 Motore esterno + pompa sommersa
 Motore esterno + pompa semi sommersa

Residential / Residenziale

Home lifts / Ascensori per abitazioni

Disabled lifts / Ascensori specifici per persone disabili

Mini lifts / Mini ascensori

**SUBMERSIBLE PUMPS / POMPE SOMMERSE**

Motor pump submersed
 Dry motor + submersed pump
 Dry motor + semi submersed pump
 Motore pompa sommerso
 Motore esterno + pompa sommersa
 Motore esterno + pompa semi sommersa

Scissor lifts / Piattaforme verticali

Parking systems / Sistemi di parcheggio

Platform lifts / Piattaforme elevatrici

Under floor lifts / Elevatori a scomparsa

**Technical characteristics / Caratteristiche tecniche**

Types / Modelli	Semi submersed - submersed / Semi sommerso - sommerso
Available models / Modelli	20 - 25 - 32 - 40 - 45 - 55 - 60 - 70 - 80
Connections / Conessioni	BSPP - GAS
Shaft rotation / Rotazione albero	Clockwise (from shaft end) for counter clockwise please contact <i>Settima Destra</i> , per rotazione sinistra si prega di contattare <i>Settima</i>
Pump body / Corpo	Aluminium / Alluminio
Main screw / Vite centrale	Steel / Acciaio
Idler screws / Viti secondarie	Cast Iron / Ghisa
Filtration / Filtrazione	Suction filter: from 250 µm / Filtro di aspirazione da 250 µm
Flow / Portate	Flow capacity from 8 to 1.200 L/min (2.950 rpm at 50Hz) Portate da 8 a 1.200 L/min (2.950 rpm at 50Hz)
Operating pressure / Pressione	80 bar max / massimo 80 bar
Temperature / Temperatura	Up to 100° C / Fino a 100° C
Viscosity / Viscosità	From 10 up to 2.000 cSt / Da 10 a 2.000 cSt
Speed / Velocità di rotazione	From 500* up to 3600 rpm / da 500* a 3600 rpm
Rotation / Rotazione	Clockwise / Destra
Acoustic emissions / Emissioni acustiche	From 58 to 77 dB (A) / Da 58 a 77 dB (A)

*For lower speed please contact *Settima*. Per velocità inferiori contattare *settima*

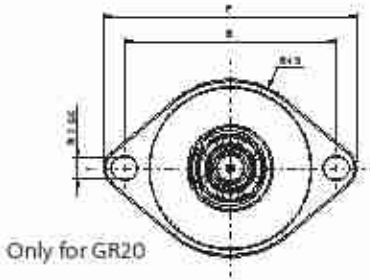
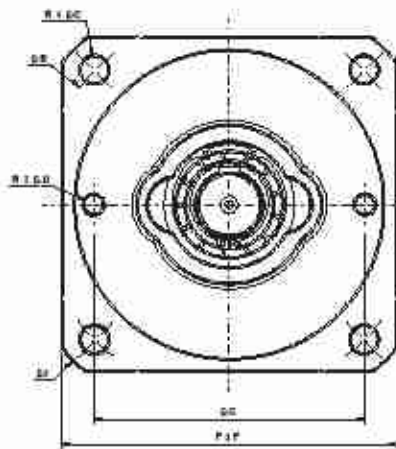

Only for GR20

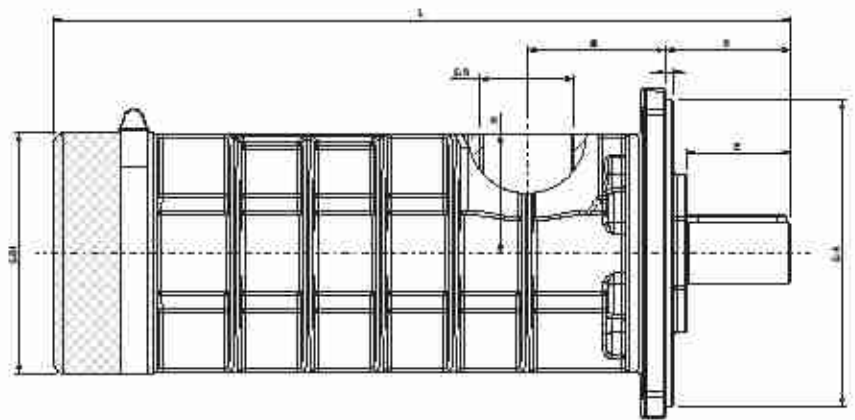

Shaft dimensions

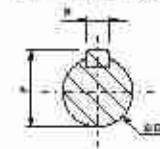

Standard

TYPE TIPO	Flange Fregia					Shaft Albero					Discharge Mandata		Pump Pompa			
	A	B	S	C	F	D	P	N	E	H	Q	D1	L	G	M	Kg
GR 20	82,55	108	-	12	130	14	16	5	30	31	1/2"	60	245	41	60	1,8
GR 25	155	190	135	14	175	19	22	6	35	45	1"	85	342	65	52	4,2
GR 32	155	190	135	14	175	19	22	6	35	45	1"	85	342	65	52	4,2
GR 40	135	190	135	14	175	19	22	6	35	76	1"	108	348	65	58	6,5
GR 45	220	260	195	18	235	32	35	10	55	65	1 1/2"	120	417	93	72	9,7
GR 55	220	260	195	18	235	32	35	10	55	76	1 1/2"	140	467	93	72	15
GR 65	220	260	195	18	235	32	35	10	55	76	2"	140	520	93	81	18
GR 70	220	260	195	18	235	32	35	10	55	95	2"	170	600	93	81	27
GR 80	270	310	-	24	340	38	41	10	60	150	3"	210	655	104	132	56

Special

TYPE TIPO	Flange Fregia					Shaft Albero					Discharge Mandata		Pump Pompa			
	A	B	S	C	F	D	P	N	E	H	Q	D1	L	G	M	Kg
GR 20 15x155	135	190	135	14	175	19	22	6	35	31	1/2"	60	265	65	37	2
GR 40 32x155	155	190	135	14	175	32	35	10	55	76	1"	108	348	65	58	6,5
GR 40 32x220	220	260	195	18	235	32	35	10	55	76	1"	108	380	93	58	7,5
GR 45 32x155	155	190	135	14	175	32	35	10	55	65	1 1/2"	120	390	65	72	8,7
GR 55 32x155	155	190	135	14	175	32	35	10	55	65	1 1/2"	120	439	65	72	14

Hollow shaft - for direct coupling with standard IEC electric motors
Albero cavo per connessione diretta con motore standard elettrico IEC

TYPE TIPO	Flange Fregia					Shaft Albero					Discharge Mandata		Pump Pompa				
	A	B	S	C	F	-	-	-	-	H	Q	D1	L	G	M	Kg	
GR 20 AC	-	106	-	12	13	For GR80 B5 - GR90 B5					31	1/2"	60	245	-	60	1,8
GR 25 AC	-	190	135	14	175	For GR100-112 B5					45	1"	85	342	-	52	4,5
GR 32 AC	-	190	135	14	175	For GR90 B5 - GR100/112 B5					45	1"	85	342	-	52	4,5

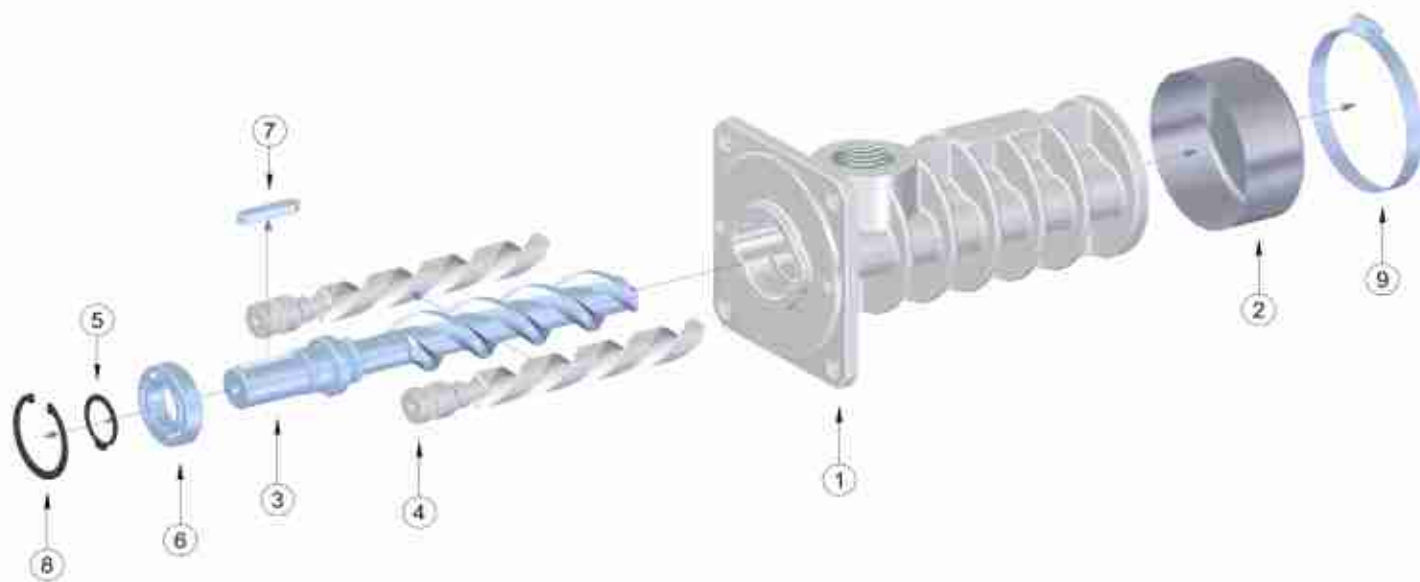

1	Pump body / Corpo pompa	Aluminum / Alluminio
2	Suction filter / Filtro aspirazione	Steel / Acciaio
3	Main screw / Vite centrale	Steel / Acciaio
4	Idler screws / Viti laterali	Cast iron / Ghisa
5	Circlip / Seeger	Steel / Acciaio
6	Ball bearing / Cuscinetto	Steel / Acciaio
7	Key / Linguetta	Steel / Acciaio
8	Circlip / Seeger	Steel / Acciaio
9	Clamp / Fascetta	Cast iron / Ghisa

GR 20

Flowrate GR20 5M @ 2750 RPM - 68 cSt

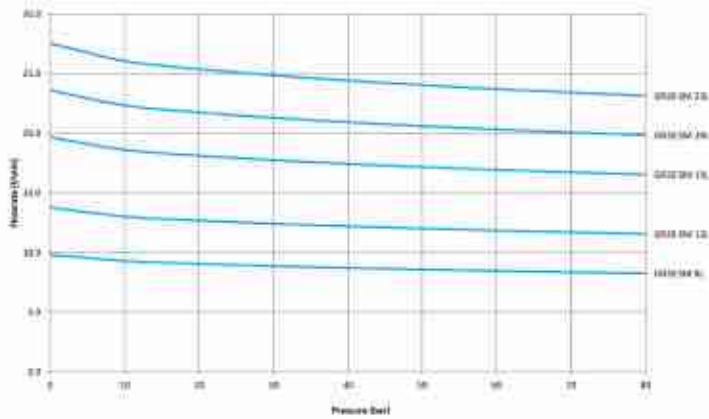

Power GR20 5M @ 2750 RPM - 68 cSt

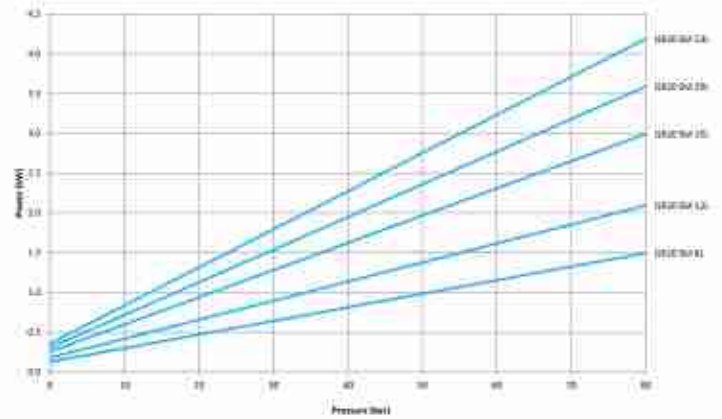

GR 25

Flowrate GR25 5M @ 2750 RPM - 68 cSt

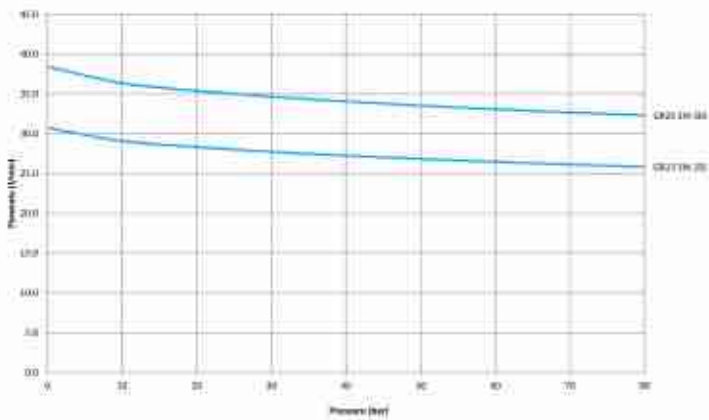

Power GR25 5M @ 2750 RPM - 68 cSt

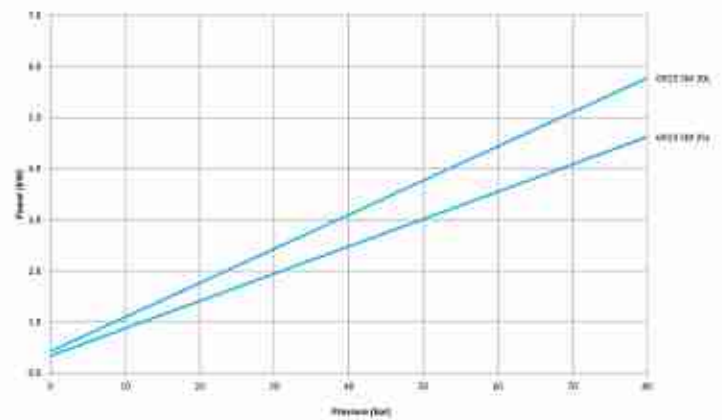

GR 32

Flowrate GR32 5M @ 2750 RPM - 68 cSt

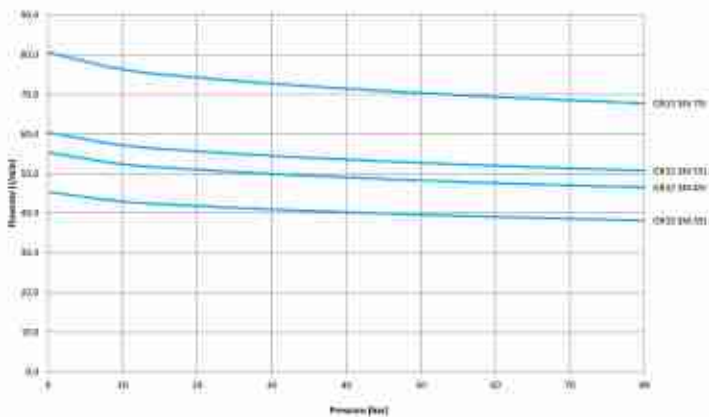

Power GR32 5M @ 2750 RPM - 68 cSt

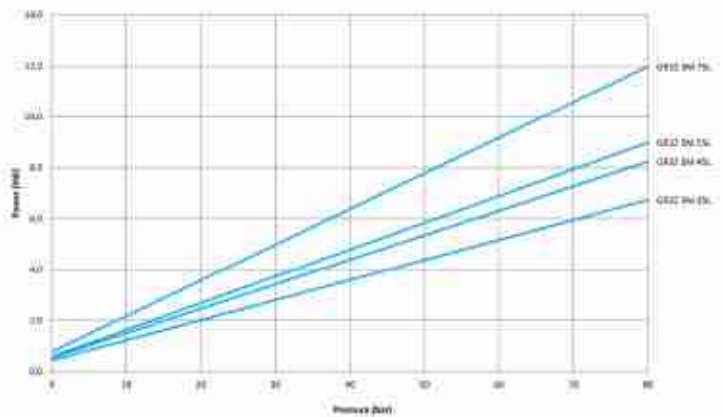

GR 40

Flowrate GR40 SM @ 2750 RPM - 68 cSt

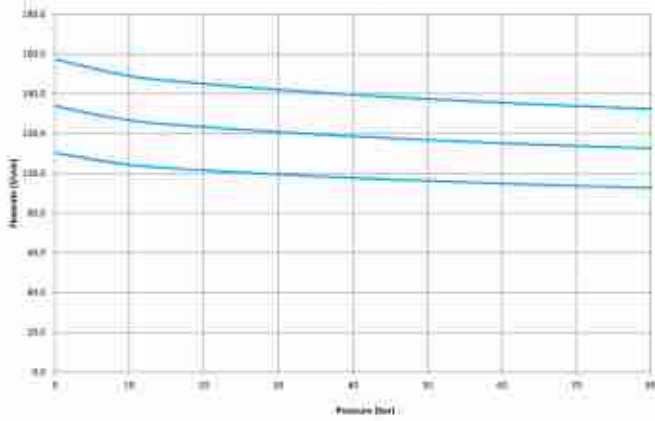

Power GR40 SM @ 2750 RPM - 68 cSt

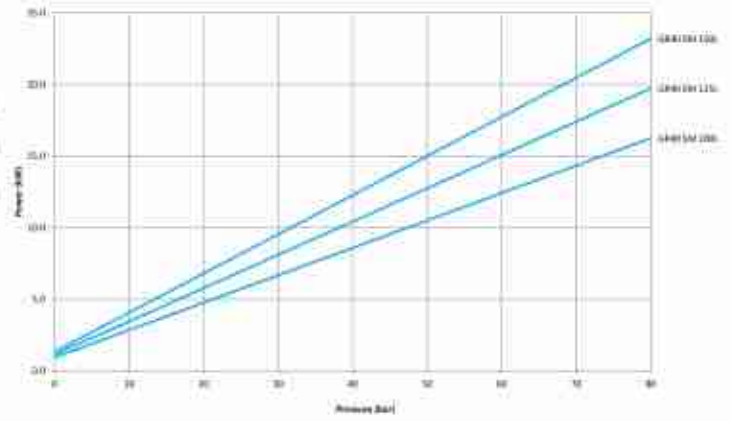

GR 45

Flowrate GR45 SM @ 2750 RPM - 68 cSt

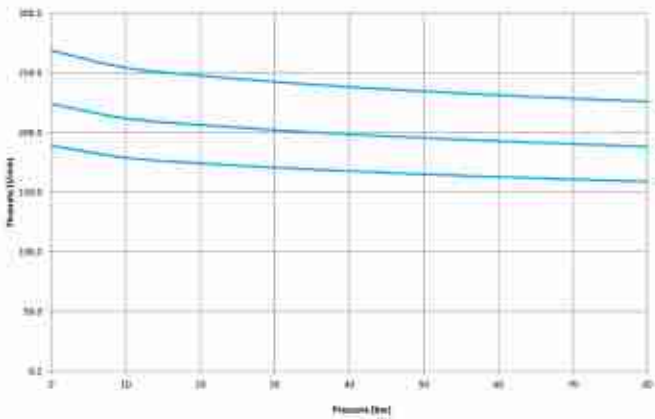

Power GR45 SM @ 2750 RPM - 68 cSt

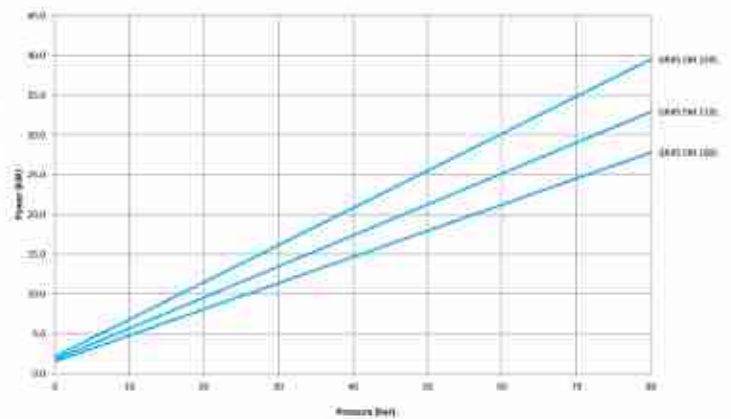

GR 55

Flowrate GR55 SM @ 2750 RPM - 68 cSt

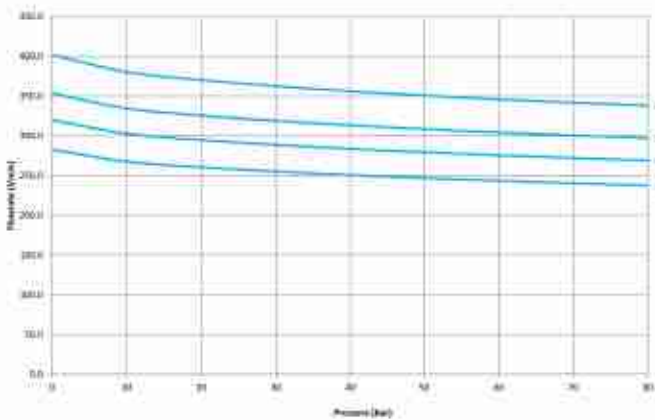

Power GR55 SM @ 2750 RPM - 68 cSt

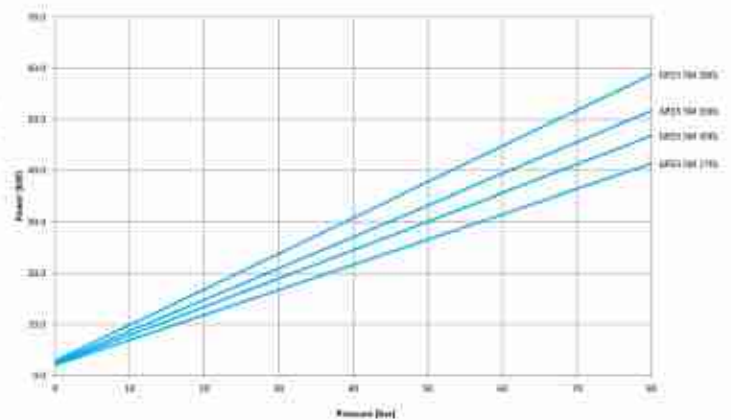

GR 60

Flowrate GR60 SM @ 2750 RPM - 68 cSt

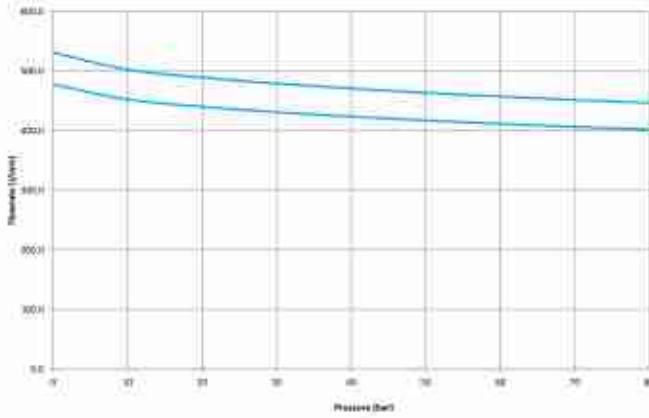

Power GR60 SM @ 2750 RPM - 68 cSt

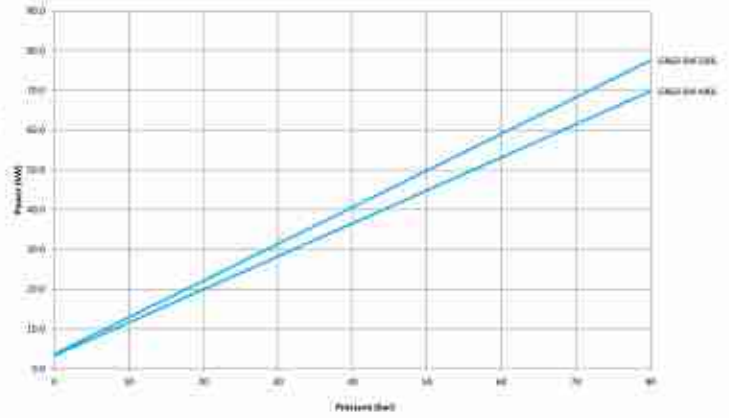

GR 70

Flowrate GR70 SM @ 2750 RPM - 68 cSt

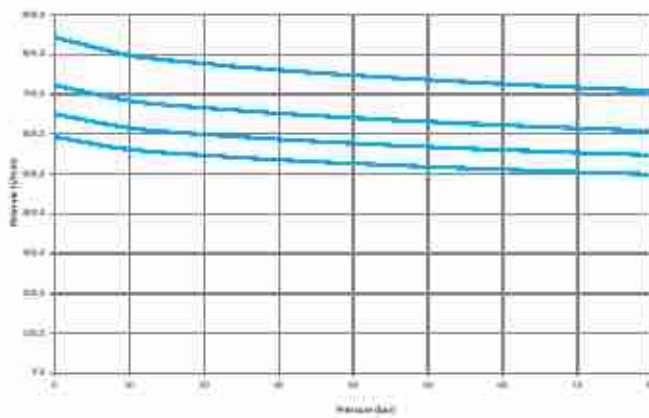

Power GR70 SM @ 2750 RPM - 68 cSt

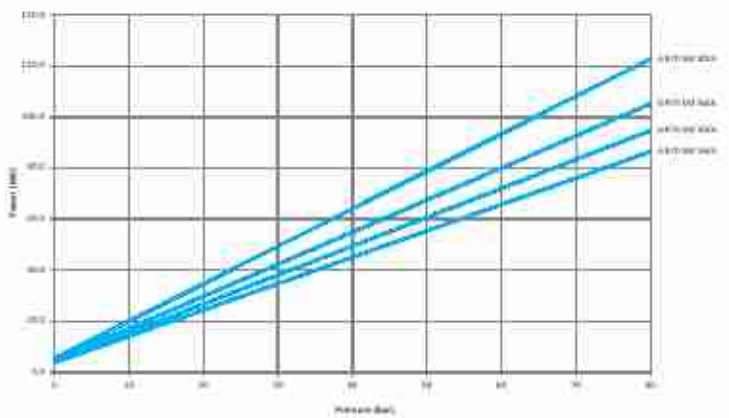

GR 80

Flowrate GR80 SM @ 2750 RPM - 68 cSt

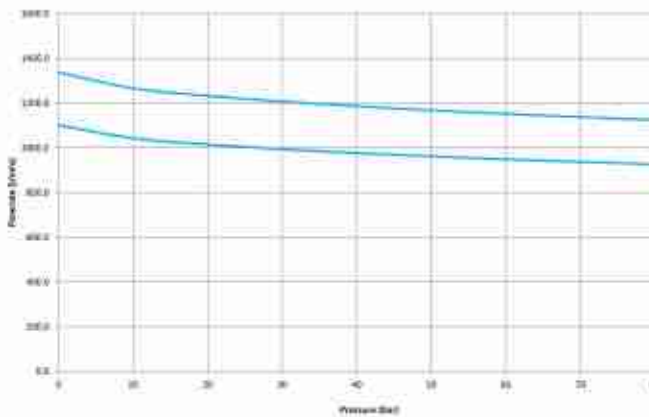

Power GR80 SM @ 2750 RPM - 68 cSt

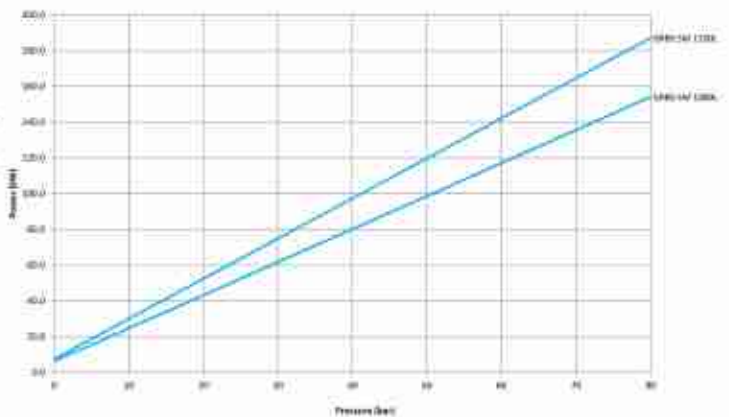

Standard

Type Tipo	Class Classe	L/min
GR20	SM	8L
		12L
		15L
		20L
		23L
GR25	SM	25L
		30L
GR32	SM	35L
		45L
		55L
		75L
GR40	SM	100L
		125L
		150L
GR45	SM	180L
		210L
		250L
GR55	SM	270L
		300L
		330L
		380L
		440L
GR60	SM	500L
		560L
GR70	SM	600L
		660L
		800L
GR80	SM	1,000L
		1,200L

Special

Type Tipo	Class Classe	L/min	Shaft Albero	Flange Flangia	Rotation Rotazione
			D	A	
GR20	SM	8L	19X	155	None DX clockwise
		12L	19X	155	
		15L	19X	155	
		20L	19X	155	
		23L	19X	155	
GR40	SM	100L	32X	155	None DX clockwise
		125L	32X	155	
		150L	32X	155	
GR40	SM	100L	32X	220	None DX clockwise
		125L	32X	220	
		150L	32X	220	
GR45	SM	180L	32X	155	* Optional SX counter clockwise
		210L	32X	155	
		250L	32X	155	
GR55	SM	270L	32X	155	* Optional SX counter clockwise
		300L	32X	155	
		330L	32X	155	
		380L	32X	155	

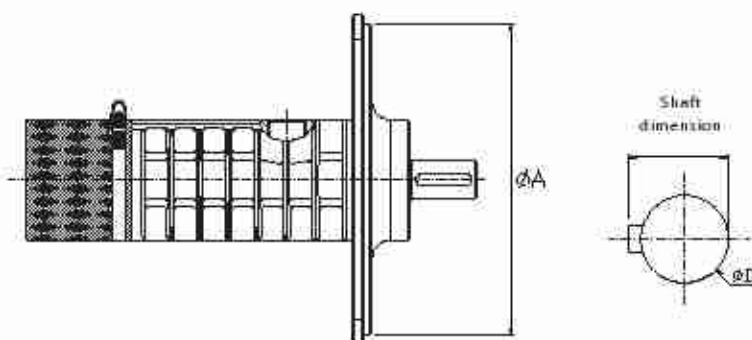

Hollow Shaft

Type Tipo	Class Classe	L/min	Hollow shaft Albero cavo	Motor shaft Albero motore	Rotation Rotazione
GR20	SM	8L, 12L, 15L, 20L, 23L	AC	19	None DX clockwise
		8L, 12L, 15L, 20L, 24L	AC	24	
GR25	SM	25L, 30L	AC	24	* Optional SX counter clockwise
		25L, 30L	AC	28	
GR32	SM	35L, 45L, 55L, 75L	AC	24	* Optional SX counter clockwise
		35L, 45L, 55L, 75L	AC	28	

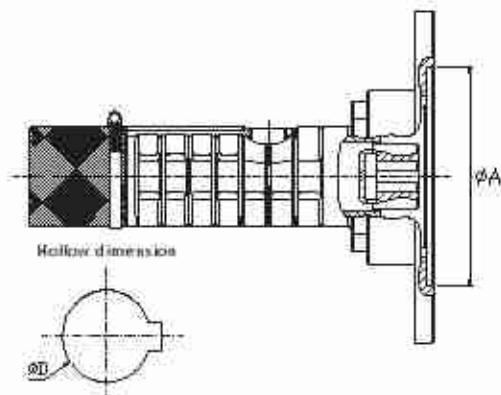

*Please contact Settima for optional rotation SX counter clockwise. Contattare Settima per rotazione SX opzionale.

The photo shows some samples of motor-pump unit, suitable for home and disabled lift or goods elevators.

The main characteristics:

- low priced
- no noise (the motor can be used without fan)
- compact
- maintainability: the external motor can be easily changed without opening the hydraulic power unit

In foto alcuni esempi di gruppi moto-pompe particolarmente adatti per ascensori casalinghi o piccole piattaforme elevatrici.

Le principali caratteristiche:

- economicità
- silenziosità (in regime di funzionamento intermittente, il motore può essere utilizzato senza ventola)
- compattezza
- facilità di manutenzione: il motore esterno è facilmente rimpiazzabile, senza aprire la centralina idraulica



Home lift heat exchanger / Scambiatori di calore per ascensori



To complete the range of pumps for lift industry, Settima designs screw pump series ideal for home lift heat exchanger.

To limit the oil overheating in heavy duty hydraulic systems such as for home lift, Settima offers a screw pump series especially manufactured:

SMT8B with hollow shaft and/or double with shaft (pump side) and hollow shaft (motor side).

Settima completa la gamma di pompe per il settore ascensoristico con una serie di pompe a viti ideali per scambiatori di calore per ascensori.

Per l'impiego negli scambiatori di calore per la limitazione del surriscaldamento dell'olio negli impianti idraulici ad elevato traffico quali le centraline degli ascensori, Settima propone una serie di pompe a viti dedicate:

SMT8B ad albero cavo e/o doppia con albero (lato pompa) e albero cavo (lato motore).

For all information about Settima SMT8B screw pump please check the SMT8B catalogue. Per informazioni sulla pompa a viti SMT8B, si prega di consultare il catalogo Settima SMT8B.

www.khadamathydraulic.com

Tell: 021-55882749

Tell: 021-33488178

Fax: 021-33488105

SETTIMA

Settima, Italy

Headquarter, r&d and production

SETTIMA

USA
Warehouse

SETTIMA

Shanghai, China
Warehouse

Settima Meccanica Srl
Settima - 29020 Piacenza (Italia)
tel. +39 0523.557623
fax +39 0523.557256
www.settima.it
info@settima.it

Settima Flow Mechanisms
Settima - 29020 Piacenza (Italia)
tel. +39 0523.557623
fax +39 0523.557256
www.settima.it
info@settimafm.com

 **SETTIMA MECCANICA**

Area Agency/Reseller

SETTIMA
flow mechanisms