	Directional spool valve type WE5 electrically operated			WK 450 187
	NS 5	up to 25 MPa	up to 16 dm³/min	08.2011

DATA SHEET - SERVICE MANUAL

APPLICATION

Directional spool valves type WE5... electrically operated are intended for change in direction of fluid flow in a hydraulic system and thus it allows to change direction of movement of a receiver - mostly piston rod of a cylinder or hydraulic motor as well to use functions: *on* and *off*. These directional spool valves are used for subplate mounting in any position in a hydraulic system.

Directional spool valve is complied with the regulations of directive 2006/95/WE for the following voltages:

- 50 – 250 V for AC
- 75 – 250 V for DC

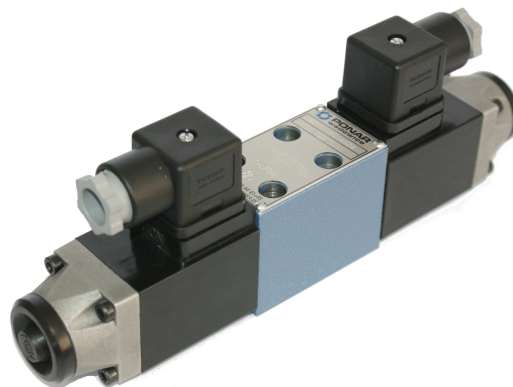

DESCRIPTION OF OPERATION

4 WE5 J - 6X/G24NZ4

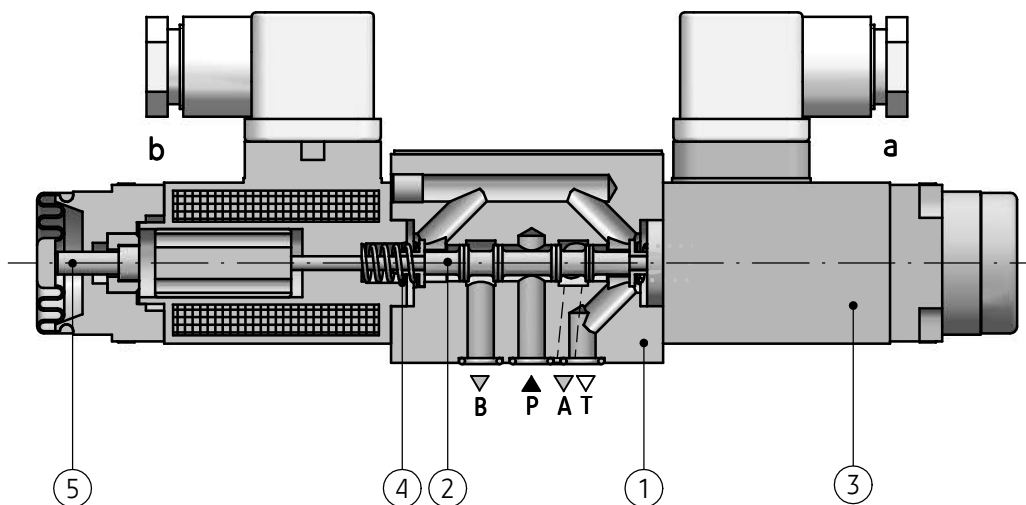

Main elements of directional spool valve type WE6... are: housing (1), solenoids (3), control spool (2), centering springs (4) and manual overrides (5).

The spool (2) is shifted when it is moved into one of end positions by the force of solenoid (3) affecting it.

The return of the spool into neutral position and centering are secured by the centering springs (4).

The shape of the spool (control edge spacing) affects the configuration of connections among the ports: **A**, **B**, **P** and **T**.

In case of emergency, the spool can be shifted manually by means of the override (5) – only for version with manual override.

When the situation is anticipated, directional spool valve must be mounted in the way as to be available.

WE5.../O...- 2-position directional spool valve without return springs. The spool is positioned and supported with attached solenoid. There is no neutral position as the spool is not positioned.

WE5...OF...- 2-position directional spool valve without return springs with detent. The spool (2) is positioned and supported with detent (6), and its shift results from supplying voltage to one solenoid (3).

TECHNICAL DATA

Hydraulic fluid	mineral oil				
Required filtration	up to 16 µm				
Recommended filtration	up to 10 µm				
Nominal fluid viscosity	37 mm ² /s at temperature 55 °C				
Viscosity range	2,8 up to 380 mm ² /s				
Fluid temperature range (in a tank)	recommended	40 °C up to 55 °C			
	max	-20 °C up to +70 °C			
Ambient temperature range	- 20 °C up to +50 °C				
Maximum operating pressure	ports P, A, B	25 MPa			
	port T	6 MPa			
Flow section in central position schemes on page 3	spool	Q		W	
	flow section	6 % nominal flow		3 % nominal flow	
Supply voltage for solenoids	DC			AC	
	12V	24V	110V	230V - 50Hz	110V - 50Hz
Power requirement	26 W			-	
Holding current	-			46 VA	
In-rush current	-			130 VA	
Duty cycle	continues			continues	
Switching time, on	40 ms			25 ms	
Switching time, off	30 ms			20 ms	
Maximum switching frequency	15000 on/h			7200 on/h	
Insulation	IP 65				
Solenoid coil temperature	max 150 °C				
Weight	1,4 kg				

ASSEMBLY AND APPLICATION REQUIREMENTS

1. Only valve working properly and suitably installed may be connected to an electric system. Only skilled workers are allowed to connect and disconnect electric system.
2. Ground connection ($\frac{\perp}{\nabla}$) must be connected with protective earth wire (PE $\frac{\perp}{\nabla}$) in supply system according to appropriate instructions.
3. It is forbidden to apply directional spool valve if the supply cable in the gland of plug-in-connector is not properly tightened.
4. It is forbidden to apply directional spool valve if the plug-in-connector is not properly tightened to the solenoid socket and is not secured by screwing bolt tightly.
5. Due to heating solenoid coils, directional spool valves should be placed in order to eliminate the possibility of incidental touch while using, or, they should be equipped with the coil covers (in accordance with the European standards PN - EN ISO 13732-1 and PN - EN 982).

SCHEMES

Graphic symbols for 3- position directional spool valves

Graphic symbols for 2- position directional spool valves

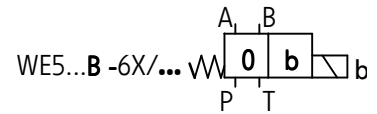
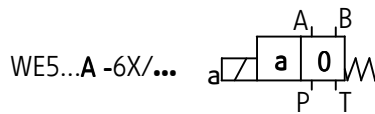

Graphic symbols for spools

working and indirect positions

working positions

working and indirect positions

working positions

working and indirect positions

working positions

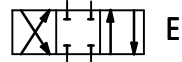
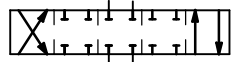
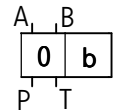
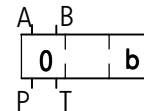
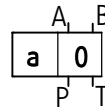
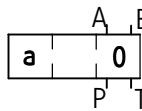
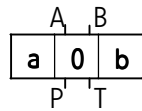
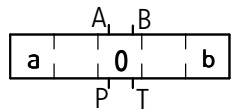

E

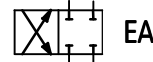
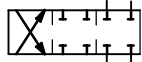

EA

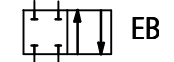
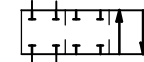

EB

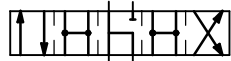

F

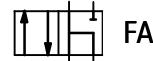
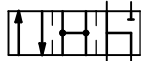

FA

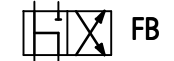
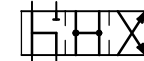

FB

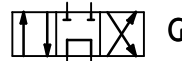
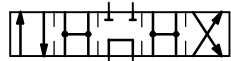

G

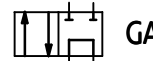
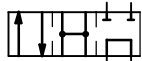

GA

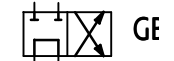
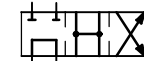

GE



H

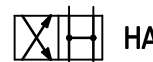

HA

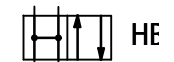
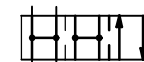

HE

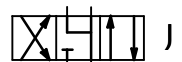
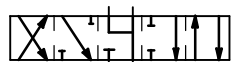

J

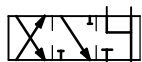

JA

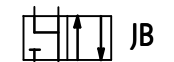
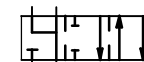

JB



L



LA

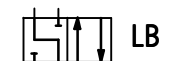

LB

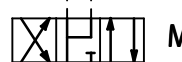
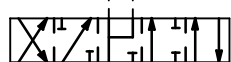

M

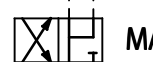
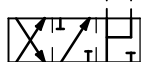

MA

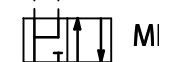
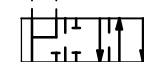

MI

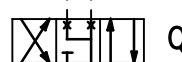
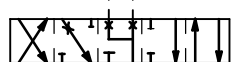

Q

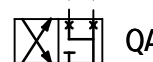
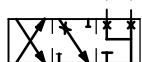

QA

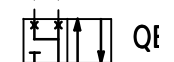
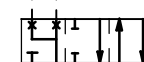

QE

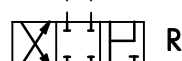
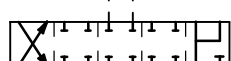

R

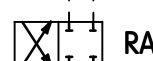
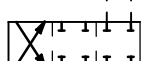

RA

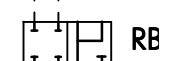
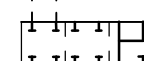

RB



U

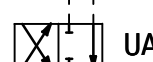

UA



UE

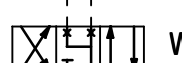
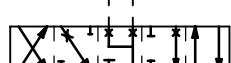

W

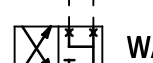
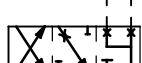

WA

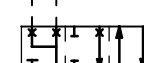

W

NOTES:

Spool **W** allows to open the flow in central position in 3% of nominal flow
 Spool **Q** allows to open the flow in central position in 6% of nominal flow

SCHEMES

Graphic symbols for 2- position directional spool valves

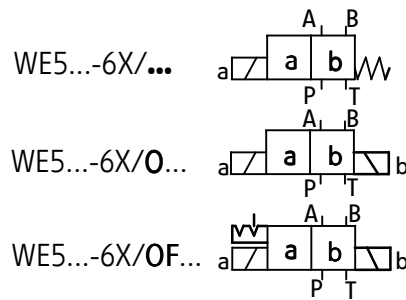

Graphic symbols for spools

working and indirect positions

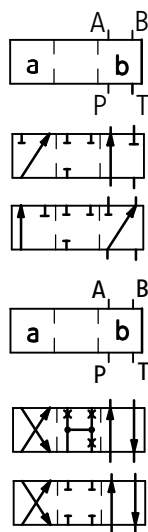

working positions

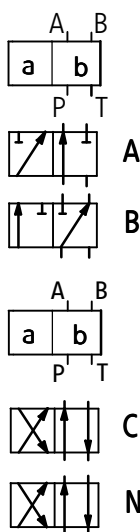

PERFORMANCE CURVES

measured at viscosity $\nu = 41 \text{ mm}^2/\text{s}$ and temperature $t = 50^\circ\text{C}$

Flow resistance curves

pressure drop related to flow for directional spool valve type **WE5...** with various spool types:
 1 - spool type **B**; 2 - spool type **R**; 3 - spool type **G**; 4 - other spool types

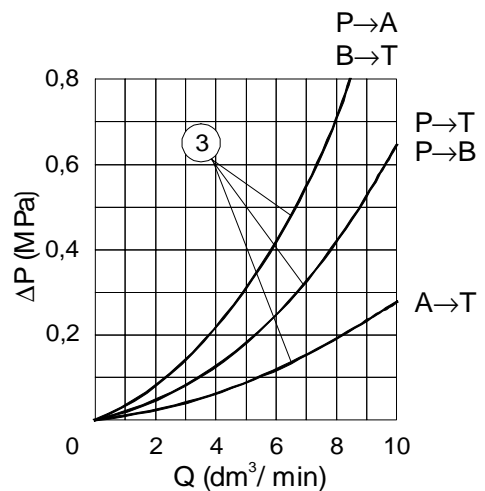
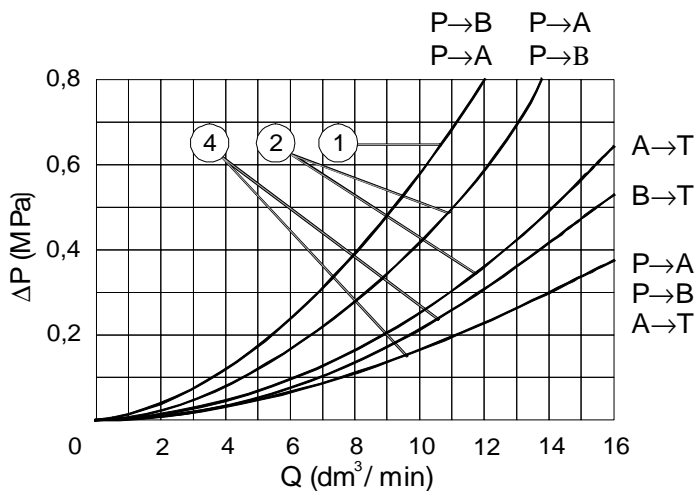

OVERALL AND CONNECTION DIMENSIONS

3-position versions ..WE5...-6X/...

2-position versions ...WE5...-6X/O... ; ...OF...

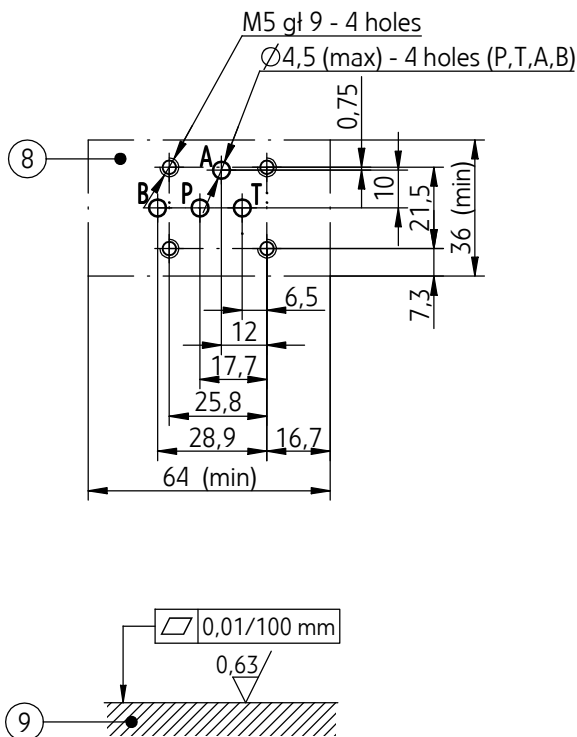
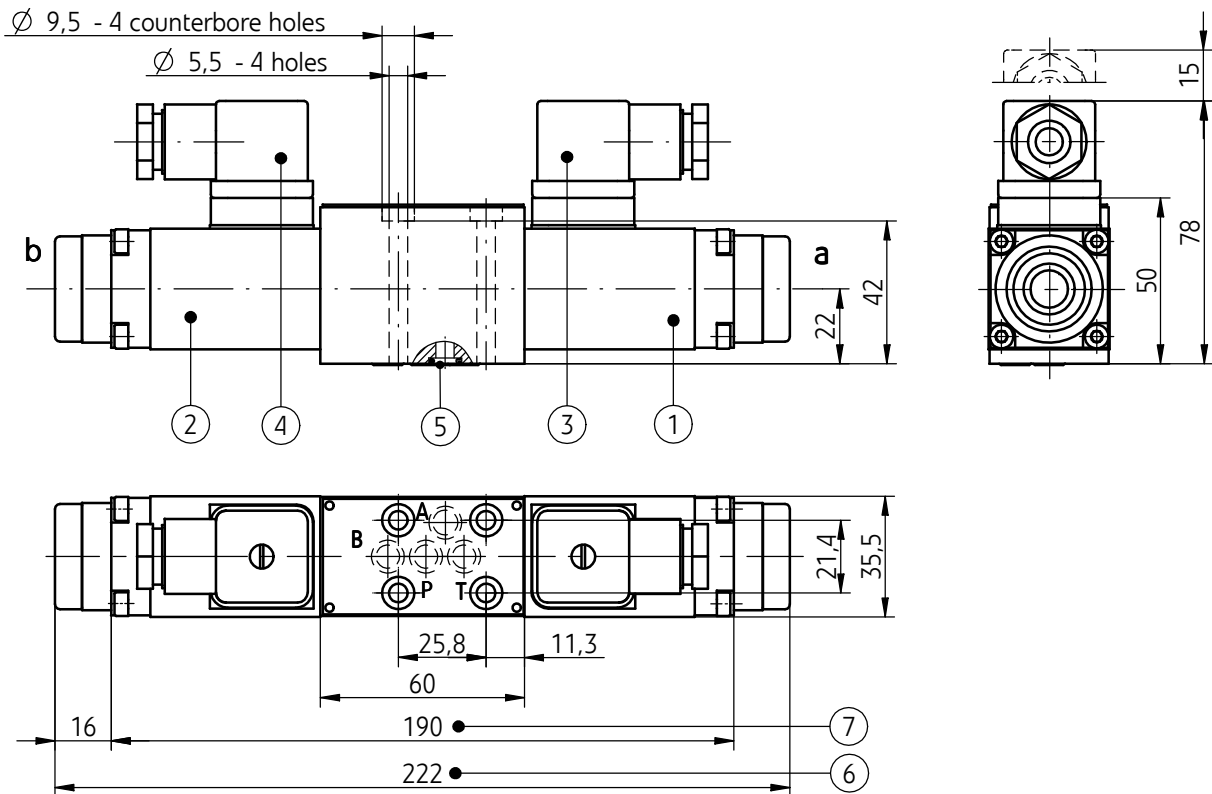

- 1 - Solenoid **a**
- 2 - Solenoid **b**
- 3 - Plug-in-connector **a** - ISO 4400 (DIN 43650 - A) type
- 4 - Plug-in-connector **b** - ISO 4400 (DIN 43650 - A) type
- 5 - O-ring **7 x 1,5** - 4 pcs/kit (P,T,A,B)
- 6 - Directional spool valve dimensions with **2 solenoids - a, b with manual override** :
 - **3-position directional spool valve springs centered**
(spool schemes: E, F, G, H, J, L, M, Q, R, U, W - according to page 3)
 - **2-position directional spool valve without return springs**
 - **2-position directional spool valve without springs and with detent**
(spool schemes: A, C, N - according to page 4)
- 7 - Directional spool valve dimensions like item 6 **without manual override**
- 8 - Mounting holes configuration of a subplate fixing bolts **M5 x 50 - 10.9** in accordance with PN -EN ISO 4762 - 4 pcs/kit tightening torque **Md = 9 Nm.**
- 9 - Subplate surface required

OVERALL AND CONNECTION DIMENSIONS

2-position versions ..WE5...-6X/...

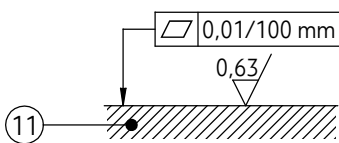
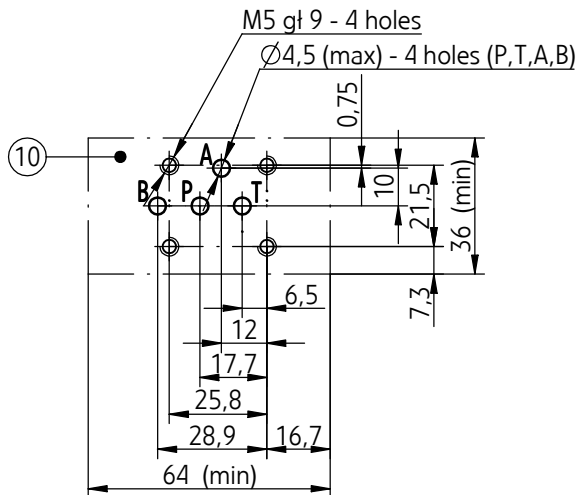
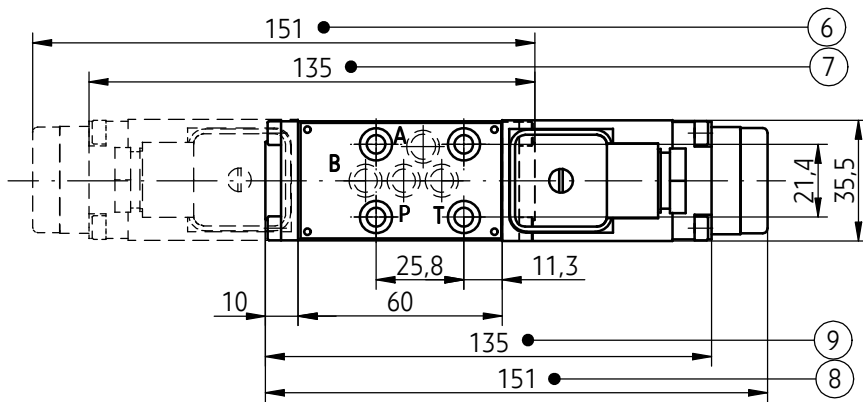
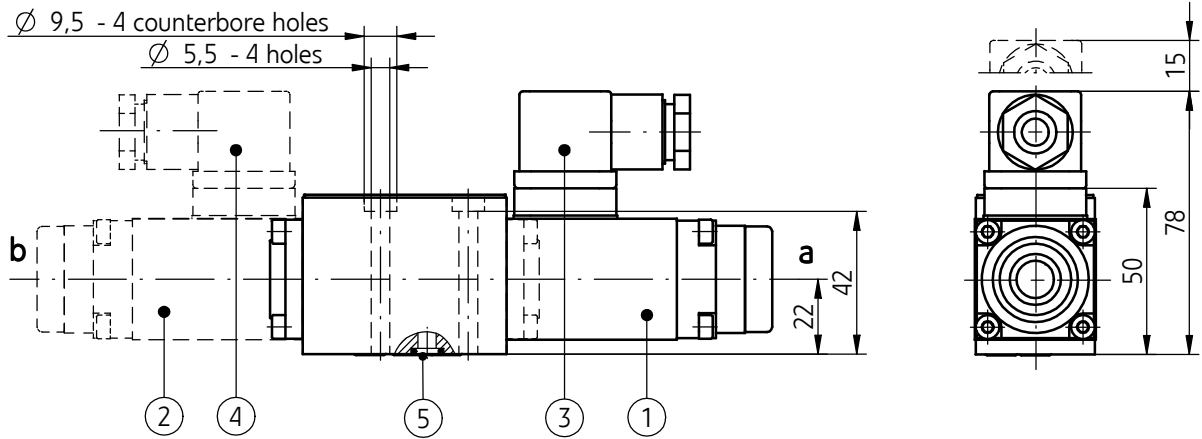

- 1 - Solenoid **a**
- 2 - Solenoid **b**
- 3 - Plug-in-connector **a** - ISO 4400 (DIN 43650 - A) type
- 4 - Plug-in-connector **b** - ISO 4400 (DIN 43650 - A) type
- 5 - O-ring 7 x 1,5 - 4 pcs/kit (P,T,A,B)
- 6 - Directional spool valve dimensions with 1 solenoid - **b** **spring positioned with manual override** (spool schemes: EB, FB, GB, HB, JB, LB, MB, QB, RB, UB, WB - according to page 3)
- 7 - Directional spool valve dimensions like item 6 **without manual override**
- 8 - Directional spool valve dimensions with 1 solenoid - **a** **spring positioned with manual override** (spool schemes: EA, FA, GA, HA, JA, LA, MA, QA, RA, UA, WA - according to page 3; A, B, C, N - according to page 4)
- 9 - Directional spool valve dimensions like item 8 **without manual override**
- 10 - Mounting holes configuration of a subplate fixing bolts **M5 x 50 -10.9** in accordance with PN -EN ISO 4762 - 4 pcs/kit tightening torque **Md = 9 Nm.** .
- 11 - Subplate surface required

EXAMPLE OF APPLICATION IN HYDRAULIC SYSTEM

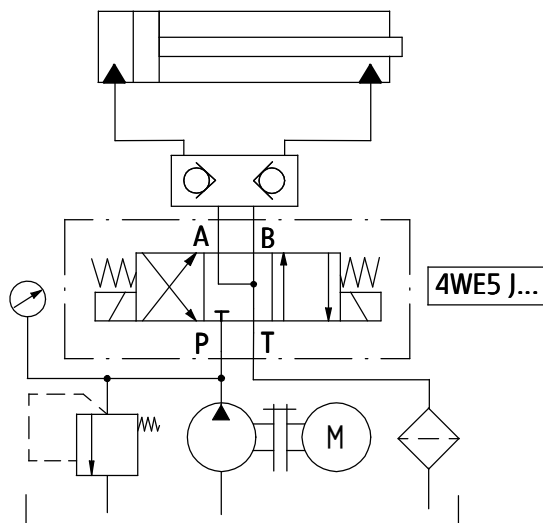

SUBPLATES AND MOUNTING BOLTS

Subplates must be ordered according to the data sheet
WK 450 980. Subplate symbol:
G 115/01 - threaded connection **G 1/4**

Subplates and bolts fixing directional valve **M5 x 50 - 10,9**
 in accordance with **PN - EN ISO 4762** - 4 pcs/kit)
must be ordered separately.
 Tightening torque for bolts: **Md = 9 Nm**

PONAR Wadowice S.A.
 ul. Wojska Polskiego 29
 34-100 Wadowice
 tel. +48 33 488 21 00
 fax. +48 33 488 21 03
www.ponar-wadowice.pl

PONAR[®]
 wadowice