



Directional spool valve type WE10 electrically operated

**WK
499 780**

NS 10

up to 31,5 MPa

up to 120 dm³/min

03.2013

DATA SHEET - SERVICE MANUAL

APPLICATION

Directional spool valves type **WE10...** electrically operated are intended for change in direction of fluid flow in a hydraulic system and thus it allows to change direction of movement of a receiver - mostly piston rod of a cylinder or hydraulic motor as well to use functions: *on* and *off*. These directional spool valves are used for subplate mounting in any position in a hydraulic system.

Directional spool valve is complied with the regulations of directive **2006/95/WE** for the following voltages:

- 50 – 250 V for AC
- 75 – 250 V for DC

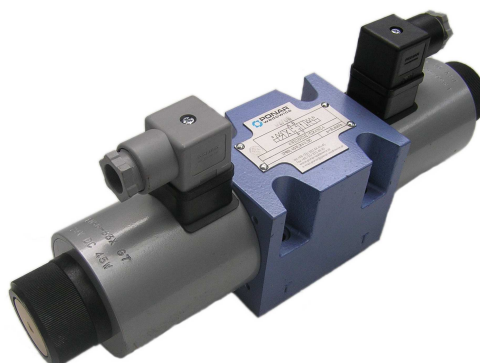

DESCRIPTION OF OPERATION

4WE10 G -15/G24NZ4

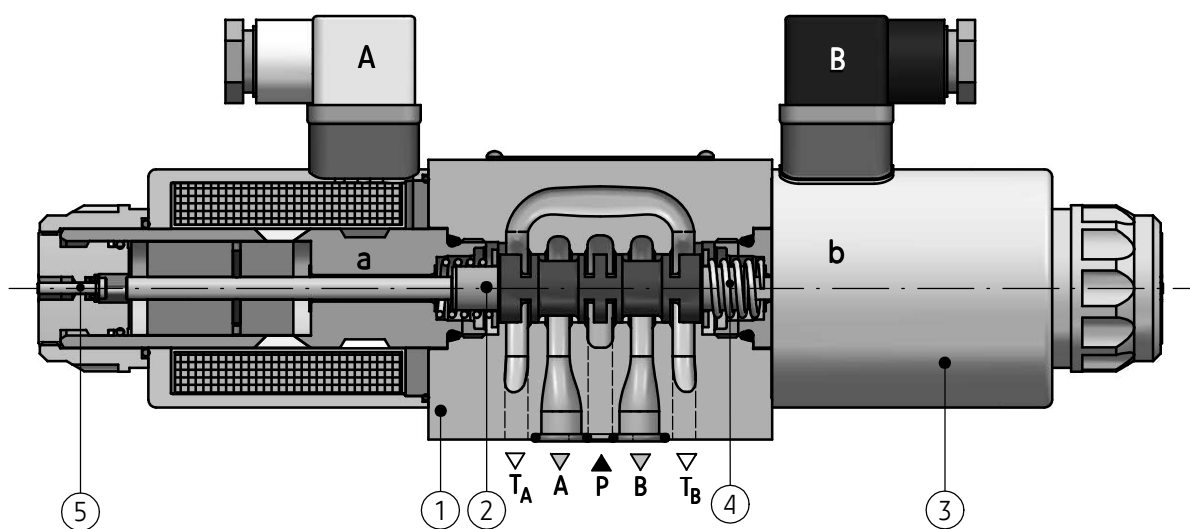

Main elements of directional spool valve type **WE10...** are: housing (1), solenoids (3), control spool (2), centering springs (4) and manual overrides (5).

The spool (2) is shifted when it is moved into one of end positions by the force of solenoid (3) affecting it. The return of the spool into neutral position and centering are secured by the centering springs (4). The shape of the spool (control edge spacing) affects the configuration of connections among the ports: **A, B, P** and **T**.

In case of emergency, the spool can be shifted manually by means of the override (5) – only for version with manual override.

When the situation is anticipated, directional spool valve must be mounted in the way as to be available.

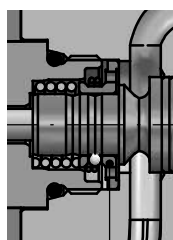

WE10.../OF... - only for spools: **A, C, D**.

Two-position directional spool valve without return springs with detent. The spool (2) is positioned and supported with detent (6), and its shift results from supplying voltage to one solenoid (3).

DESCRIPTION OF OPERATION

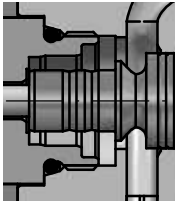

WE10.../O... - only for spools: **A, C, D**.
Two-position directional spool valve without return springs. The spool is positioned and supported with attached solenoid. There is no neutral position as the spool is not positioned.

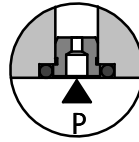

WE10.../...B... - directional spool valve designation like that, has throttle insert in port **P**.

TECHNICAL DATA

Hydraulic fluid	mineral oil					
Required filtration	up to 16 µm					
Recommended filtration	up to 10 µm					
Nominal fluid viscosity	37 mm ² /s at temperature 55 °C					
Viscosity range	2,8 up to 380 mm ² /s					
Fluid temperature range (in a tank)	recommended	40 °C up to 55 °C				
	max	-20 °C up to +70 °C				
Ambient temperature range	- 20 °C up to +50 °C					
Maximum operating pressure	ports P, A, B	31,5 MPa				
	port T	21 MPa				
Flow section in central position schemes on page 3	spool	Q	W	V		
	flow direction	A → T B → T	A → T B → T	A → T B → T	P → A P → B	
	flow section	5,5 mm ²	2,5 mm ²	11 mm ²	10 mm ²	
Switching time	ON	up to 60 ms				
	OFF	up to 40 ms				
Maximum switching frequency	15000 on/h					
Weight	with 1 solenoid - max 4,6 kg					
	with 2 solenoids - max 6,2 kg					
Supply voltage for solenoids	DC			AC (plug-in connector with rectifier)		
	12V	24V	110V	230V - 50Hz	220V - 50Hz	110V - 50Hz
Supply voltage tolerances	±10%					
Power requirement (DC)	45 W					
Insulation	IP 65					
Solenoid coil temperature	max 150 °C					

ASSEMBLY AND APPLICATION REQUIREMENTS

1. Only valve working properly and suitably installed may be connected to an electric system. Only skilled workers are allowed to connect and disconnect electric system.
2. Ground connection (\perp) must be connected with protective earth wire (PE \perp) in supply system according to appropriate instructions.
3. It is forbidden to apply directional spool valve if the supply cable in the gland of plug-in-connector is not properly tightened.
4. It is forbidden to apply directional spool valve if the plug-in-connector is not properly tightened to the solenoid socket and is not secured by screwing bolt tightly.
5. Due to heating solenoid coils, directional spool valves should be placed in order to eliminate the possibility of incidental touch while using, or, they should be equipped with the coil covers (in accordance with the European standards PN - EN ISO 13732-1 and PN - EN 982).

SCHEMES

Graphic symbols for 3- position directional spool valves

WE10...-1X/...

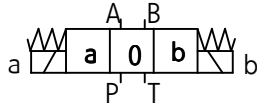

Graphic symbols for 2- position directional spool valves

WE10...A-1X/...

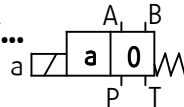

WE10...B-1X/...

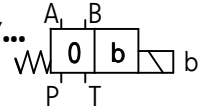

Graphic symbols for spools

working and indirect positions

working positions

working and indirect positions

working positions

working and indirect positions

working positions

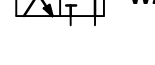
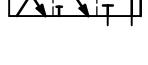
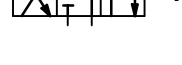
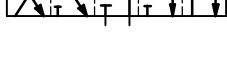
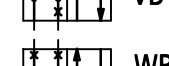
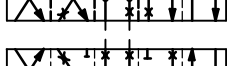
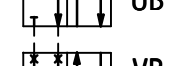
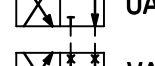
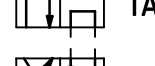
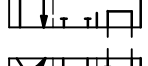
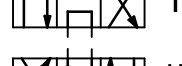
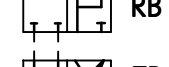
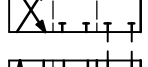
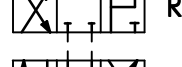
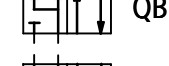
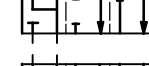
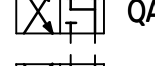
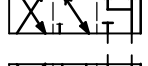
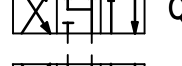
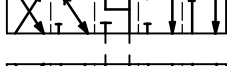
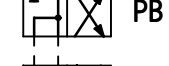
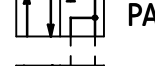
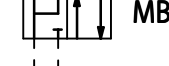
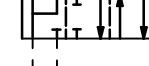
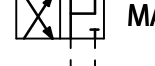
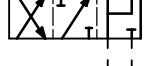
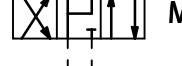
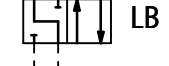
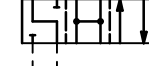
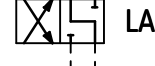
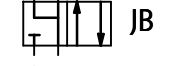
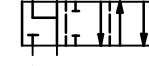
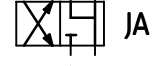
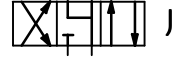
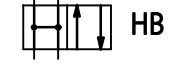
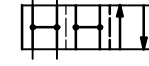
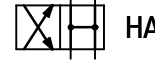
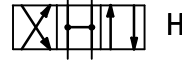
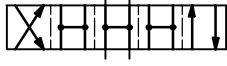
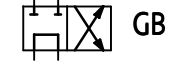
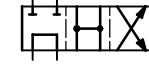
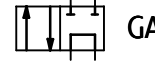
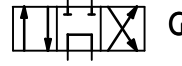
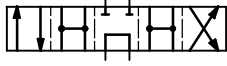
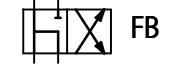
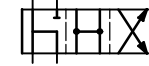
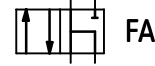
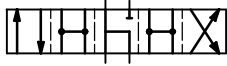
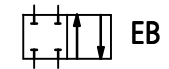
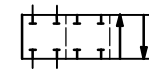
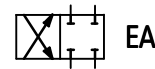
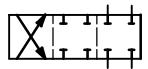
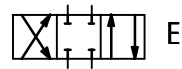
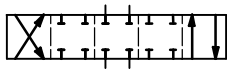
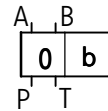
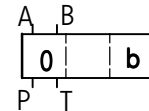
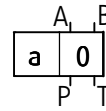
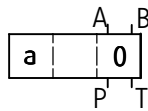
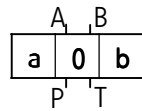
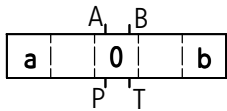

NOTES:

Flow section in central position for spools:
Q, W, V - according to page 2

SCHEMES

Graphic symbols for 2- position directional spool valves

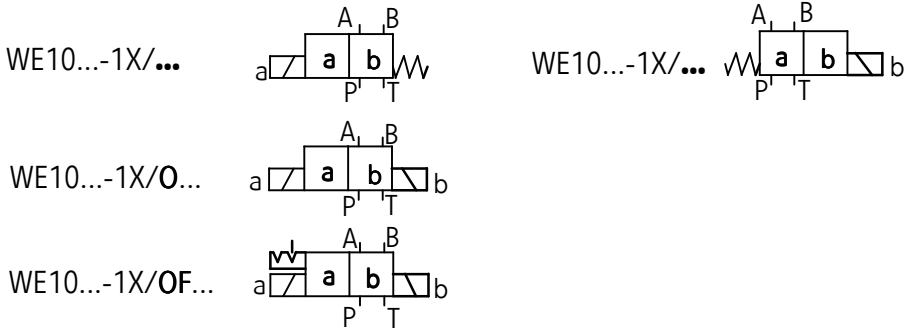

Graphic symbols for spools

working and indirect positions

working positions

working and indirect positions

working positions

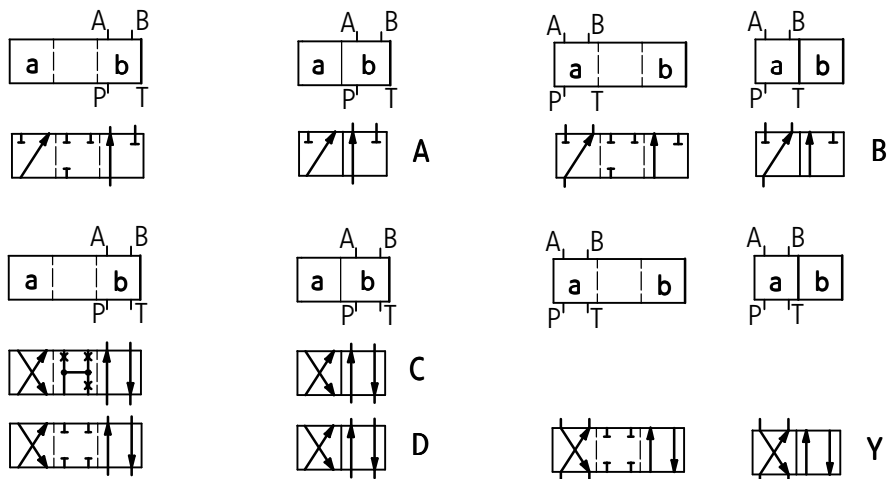

OVERALL AND CONNECTION DIMENSIONS

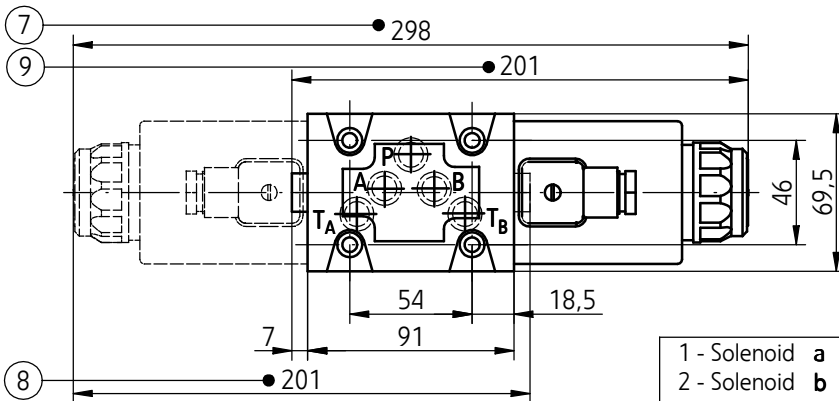
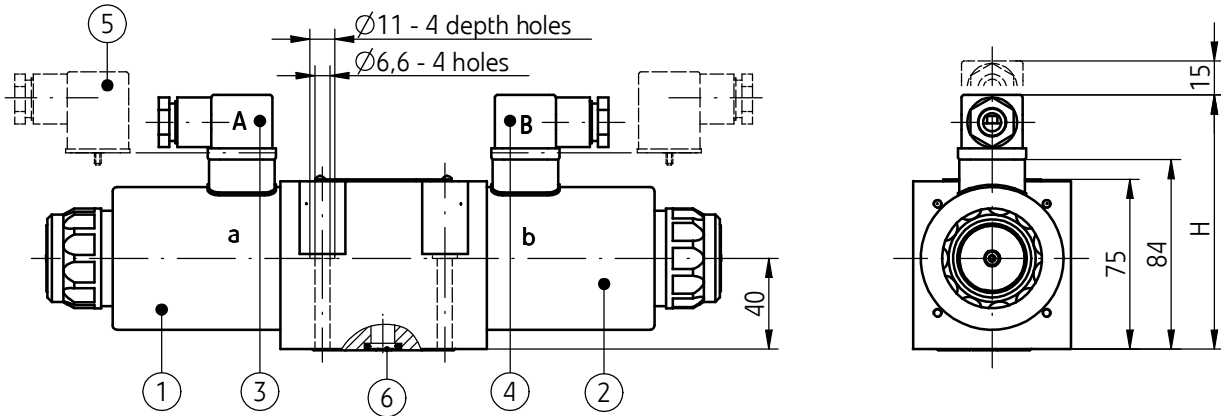

electrical connection type		dimension H
plug-in-connectors ISO 4400 type	control voltage - DC 12V, 24V, 110V	112
plug-in-connectors ISO 4400 type with rectifier	control voltage - AC 110V, 220V, 230V	119

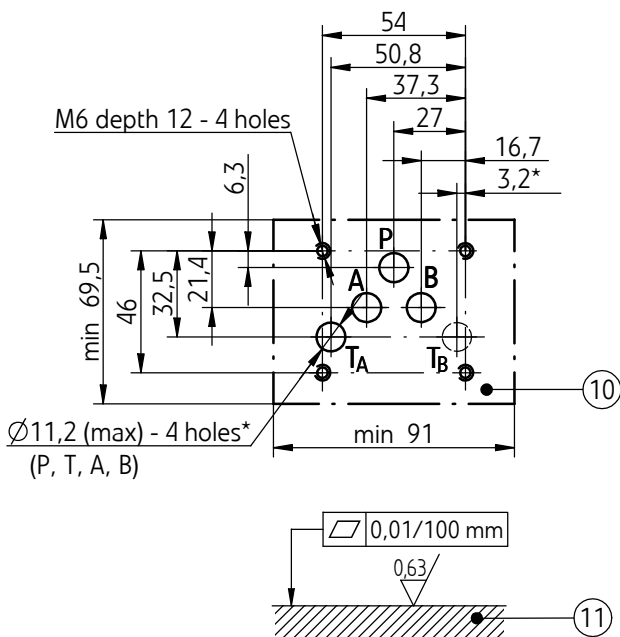

- 1 - Solenoid a
- 2 - Solenoid b
- 3 - Plug-in-connector A (ISO 4400 type)
- 4 - Plug-in-connector B (ISO 4400 type)
- 5 - Plug-in-connector (ISO 4400 type) with rectifier
- 6 - O-ring 12 x 2 - 5 pcs/kit (P, T_A, T_B, A, B)
- 7 - Directional spool valve size with 2 solenoids - a, b
 - 3-position directional spool valve springs centered (spool symbols: E, F, G, H, J, L, M, Q, R, T, U, V, W - according to page 3)
 - 2-position directional spool valve without return springs
 - 2-position directional spool valve without springs and with detent (spool symbols: A, C, D - according to page 4)
- 8 - Directional spool valve size with 1 solenoid - a
 - 2-position springs centered (spool symbols: A, C, D, EA, FA, GA, HA, JA, LA, MA, PA, QA, RA, TA, UA, VA, WA - according to page 3 and 4)
- 9 - Directional spool valve size with 1 solenoid - b
 - 2-position springs centered (spool symbols: B, Y, EB, FB, GB, HB, JB, LB, MB, PB, QB, RB, TB, UB, VB, WB - according to page 3 and 4)
- 10 - Porting pattern for directional spool valve configuration of subplate holes in accordance with the following standards:
 - CETOP RP 121H - identified by CETOP 4.2-4-05 (nominal size CETOP 05)
 - ISO 4401 - identified by ISO 4401-05-04-0-94
- (*) - connection with 1 hole T from the side of the hole A or B is enough - holes T_A and T_B are connected with the port in the housing of directional spool valve mounting bolts M6 x 50 - 10.9 in accordance with PN -EN ISO 4762 - 4 pcs/kit tightening torque Md = 15 Nm.
- 11 - Subplate surface required

PERFORMANCE CURVES

measured at viscosity $\nu = 41 \text{ mm}^2/\text{s}$ and temperature $t = 50^\circ\text{C}$

Flow resistance curves

Characteristic curves $\Delta p(Q)$ for directional spool valves type WE10...-15/... for various spool types

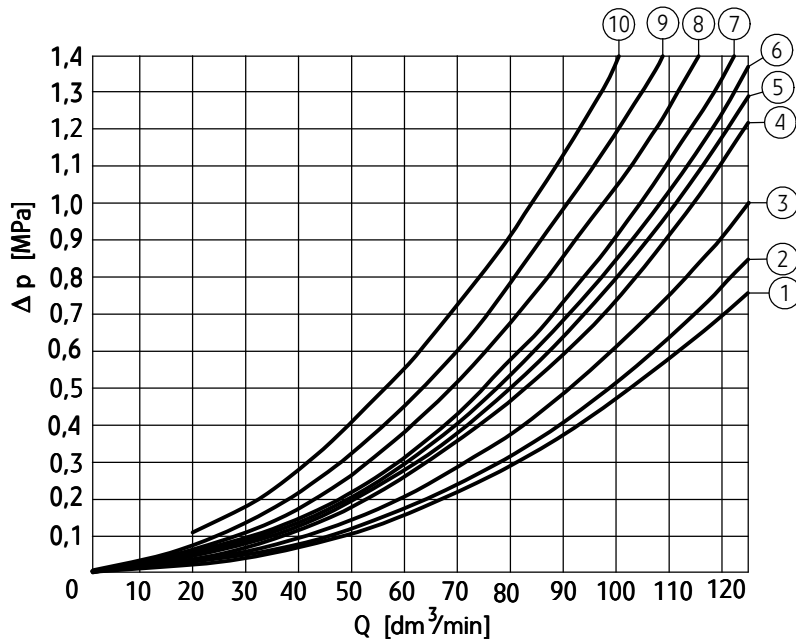

Spool type schemes according to page 3, 4	Performance diagram number			
	flow direction			
	P → A	P → B	A → T	B → T
A, B	3	3	-	-
C	3	3	4	5
D, Y	5	5	6	6
E	1	1	4	4
F	2	3	7	4
G	3	3	6	7
H	1	1	6	7
J	1	1	3	3
L	2	2	3	5
M	1	1	4	5
P	4	2	5	7
Q	1	2	1	3
R	3	6	4	-
T	3	3	6	7
U, V	2	2	3	3
W	2	2	4	5

Spool type	Performance diagram number					
	flow direction					
central position (O) scheme - page 3	P → A	P → B	P → T	A → T	B → T	B → A
F	4	-	9	9	-	-
P	-	5	10	-	8	-
G, T	-	-	9	-	-	-
H	-	-	3	-	-	-

Spool type	Performance diagram number					
	flow direction					
shifted position scheme - page 3	P → A	P → B	P → T	A → T	B → T	B → A
R	-	-	-	-	-	9

Flow limit curves

Characteristic curves $p-Q$ for directional spool valves type WE10...-15/.. with DC solenoids for various spool types

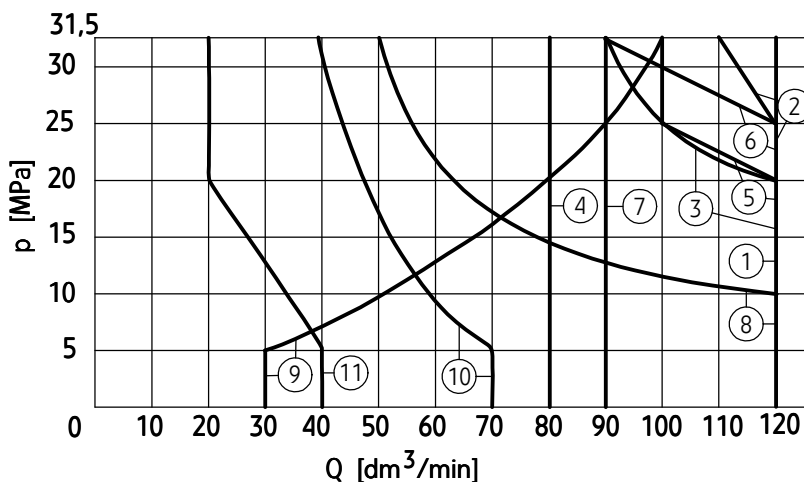

Spool type schemes according to page 3, 4	Performance diagram number
C, C/O, C/OF D, D/O, D/OF, Y M	1
E	2
J,	3
H, Q, W	4
R	5
L	6
U	7
A, A/OF, B	8
V	9
F, P, G	10
T	11

NOTES:

Above flow limits are related to symmetrical flow through all ports i.e. if the oil flows from port P to port A, then the same flow rate flows out from

ACCESSORIES

Spool position monitoring

Additional technical data

Inductive switch	
Type of switches	PNP inductive proximity switches normally closed - NC normally opened - NO
Range of supply voltage for switch	10 - 30V DC
Max load current	200 mA
Type of switch connection	external thread M12x1 ; male connection; 4 contacts (pins)
Insulation	IP 65
Weight	
with one solenoid and one switch	max 5,6 kg
with two solenoids and one switch	max 7,2 kg
with two solenoids and two switches	max 8,5 kg

Scheme of electrical connection of inductive switch

Normally open (NO)- S1

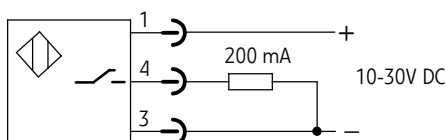

Normally closed (NC)- S2

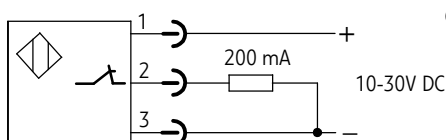

Contact allocation (pins of switch connector)

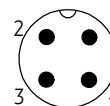

Graphic symbols for directional control valves and initial positions of switches

Initial position of inductive switch depending on the spool position	Graphic symbol for directional control valve
<p>0 - off neutral state on output contact (NO - contact 4; NC - contact 2)</p> <p>1 - on state on output contact (NO - contact 4; NC - contact 2)</p>	
3-position directional control valve	
<p>position monitored "a" and "b"</p> <p>Normally open</p>	
<p>position monitored "0"</p> <p>Normally open</p>	
<p>Normally closed</p>	
<p>Normally closed</p>	

ACCESSORIES

Spool position monitoring

Initial position of inductive switch depending on the spool position		Graphic symbol for directional control valve
2-position directional control valve WE10...A (positions: a, 0) solenoid and switch on side "a"		
position monitored "a"	position monitored "0"	
<p>Normally open</p> <p>Normally closed</p> <p>0 50 100 "0" spool position [%] "a"</p>	<p>Normally open</p> <p>Normally closed</p> <p>0 50 100 "0" spool position [%] "a"</p>	
2-position directional control valve WE10...B (positions: 0, b) solenoid and switch on side "b"		
position monitored "0"	position monitored "b"	
<p>Normally open</p> <p>Normally closed</p> <p>0 50 100 "0" spool position [%] "a"</p>	<p>Normally open</p> <p>Normally closed</p> <p>0 50 100 "0" spool position [%] "a"</p>	
2-position directional control valve WE10 A, D, C; .../O; .../OF switch on side "a"		
position monitored "a"	position monitored "b"	
<p>Normally open</p> <p>Normally closed</p> <p>0 50 100 "0" spool position [%] "a"</p>	<p>Normally open</p> <p>Normally closed</p> <p>0 50 100 "0" spool position [%] "a"</p>	
2-position directional control valve WE10B, Y switch on side "b"		
position monitored "a"	position monitored "b"	
<p>Normally open</p> <p>Normally closed</p> <p>0 50 100 "0" spool position [%] "a"</p>	<p>Normally open</p> <p>Normally closed</p> <p>0 50 100 "0" spool position [%] "a"</p>	

ACCESSORIES

Spool position monitoring

Overall dimensions

Directional control valve with two solenoids and two switches

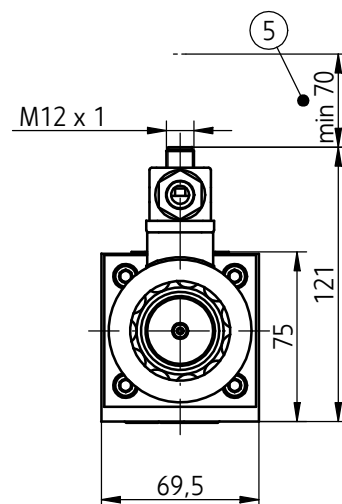
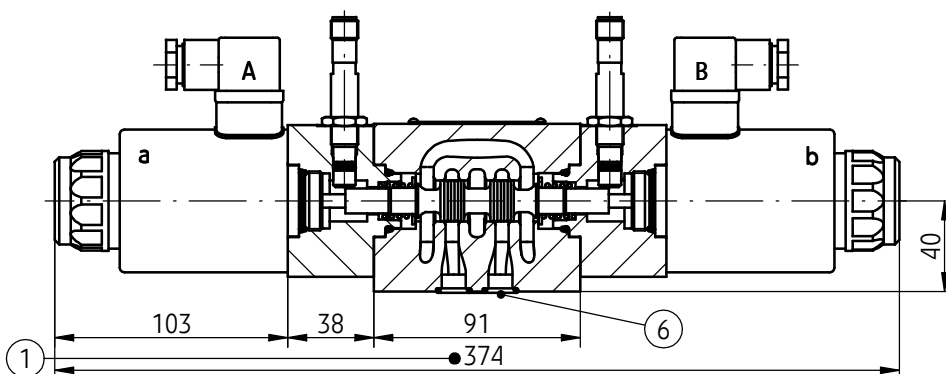

Directional control valve with one solenoid and one switch

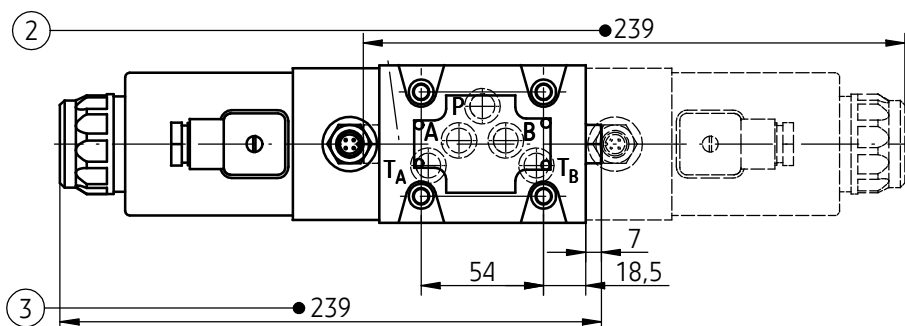

Directional control valve with two solenoids and one switch

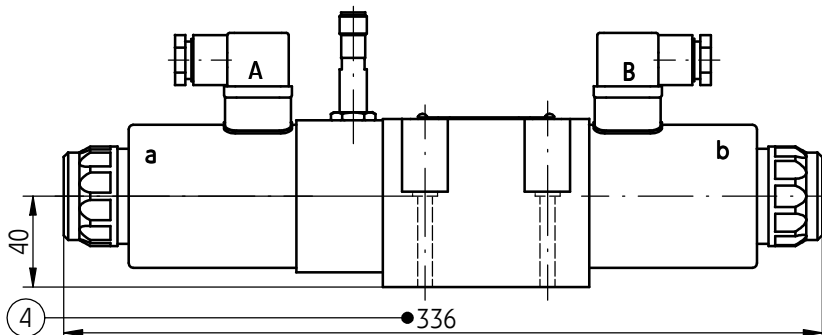

Subplate surface required according to page 5

Note:

- Directional control valve with spool position switch is adjusted. Any adjustments may be made only by the manufacturer.
- In case of a faulty switch or valve complete directional control valve must be changed.

1 - Dimension of directional control valve with **two solenoids - a, b** and **two position switches**

- **3-position, springs centered**

WE10.../...S1...; ...S2...

(spool symbols: E, F, G, H, J, L, M, P, Q, R, T, U, V, W - on page 3)

2 - Dimension of directional control valve with **one solenoid - a** and **one position switch**

- **2-position, springs centered**

WE10.../...S1; ...S2...

(spool symbols: A, C, D, EA, FA, GA, HA, JA, LA, MA, PA, QA, RA, TA, UA, VA, WA - on pages 3, 4)

3 - Dimension of directional control valve with **one solenoid - b**

- **2-position, springs centered**

WE10.../...S1...; ...S2...

(spool symbols: B, Y, EB, FB, GB, HB, JB, LB, MB, PB, QB, RB, TB, UB, VB, WB - on pages 3, 4)

4 - Dimension of directional control valve with **two solenoids - a, b** and **position switch at A side**

- **2-position, without spring return**

WE10.../O...S1...; ...S2...

- **2-position, without spring return, with detent**

WE10.../OF...S1...; ...S2...

(spool symbols: A, C, D - on page 4)

5 - Distance for mounting plug-in-connector and cable of switch (plug-in-connectors not showed in the drawing must be ordered separately according to data sheet **WK 499 963**).

6 - **O-ring 12 x 2** - 5 pcs/kit (P, T_A, T_B, A, B)

HOW TO ORDER

	WE	10		/						
--	-----------	-----------	--	---	--	--	--	--	--	--

Number of service ports
3-way - for spools A, B = **3**
4-way - for the other spools = **4**

Nominal size (NS)
NS10 = **10**

Spool type
spool symbol - according to **page 3, 4**

Series number
 (10-19) - connection and installation dimensions unchanged = 1X
series 15 = **15**

Spool positioning/centering
spring centering = **no designation**
 without springs return = **0**
 without springs return with detent = **OF**

Control voltage for solenoids
 12V DC = **G12**
24V DC = **G24**
 110V DC = **G110**
 110V AC 50Hz (plug-in-connector with rectifier) = **W110R**
 220V AC 50Hz (plug-in-connector with rectifier) = **W220R**
230V AC 50Hz (plug-in-connector with rectifier) = **W230R**

Manual override
 solenoids without manual override = **no designation**
solenoids with manual override = **N**

Electrical connection
plug-in-connector ISO 4400 type without LED = **Z4**
 plug-in-connector ISO 4400 type with LED = **Z4L**

Throttle insert (in port P)
without throttle insert = **no designation**
 throttle insert ϕ 0,8 = **B 08**
 throttle insert ϕ 1,0 = **B 10**
 throttle insert ϕ 1,2 = **B 12**
 throttle insert ϕ 3,0 = **B 30**

Sealing
NBR (for fluids on mineral oil base) = **no designation**
 FKM (for fluids on phosphate ester base) = **V**

HOW TO ORDER

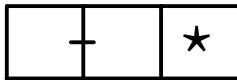

Further requirements in dear text
(to be agreed with the manufacturer)

Spool position monitoring

monitored position "0" - "zero" (3 and 2- position directional control valves
with positions (a, 0) or (0, b)) = 0

monitored position "a" (2- position directional control valves
with positions (a, 0) or (a, b) with spools A, D, C, .../O; .../OF and B, Y) = A

monitored position "b" (2- position directional control valves
with positions (0, b) or (a, b) with spools A, D, C, .../O .../OF and B, Y) = B

monitored positions "a" and "b" (3- position directional control valves) = AB

Spool position switch

normally open = S1

normally closed = S2

NOTES:

Directional spool valve should be ordered according to the above coding.

The symbols in bold are preferred versions in short delivery time.

Coding example: 4WE10 E - 15/G24 N Z4 B08 S1 - AB

EXAMPLE OF APPLICATION IN HYDRAULIC SYSTEM

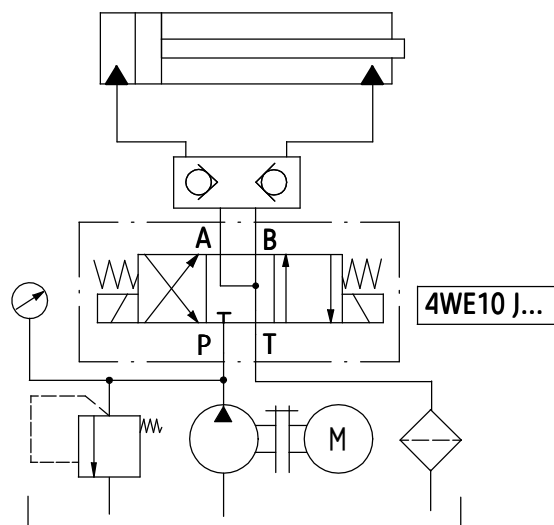

SUBPLATES AND FIXING SCREWS

Subplates must be ordered according to the data sheet **WK 496 520**. Subplates:

G 66/01 - threaded connection G 3/8

G 67/01 - threaded connection **G 1/2**

G 89/01 - threaded connection G1/4

G 67/02 - threaded connection M22 x1,5

Subplates and bolts fixing directional valve **M6 x 50 - 10,9** in accordance with **PN-EN ISO 4762** - 4 pcs/kit must be ordered separately.

Tightening torque for bolts $Md = 15 \text{ Nm}$

The subplate symbol in bold is the preferred version available in short delivery time.

PONAR Wadowice S.A.
ul. Wojska Polskiego 29
34-100 Wadowice
tel. +48 33 488 21 00
fax. +48 33 488 21 03
www.ponar-wadowice.pl

 **PONAR**[®]
wadowice