

# RQM\*-P

## SOLENOID OPERATED PRESSURE RELIEF VALVES WITH UNLOADING AND PRESSURE SELECTION

### SERIES 60

#### SUBPLATE MOUNTING

RQM3-P ISO 6264-06 (CETOP R06)

RQM5-P ISO 6264-08 (CETOP R08)

RQM7-P ISO 6264-10 (CETOP R10)

#### OPERATING PRINCIPLE

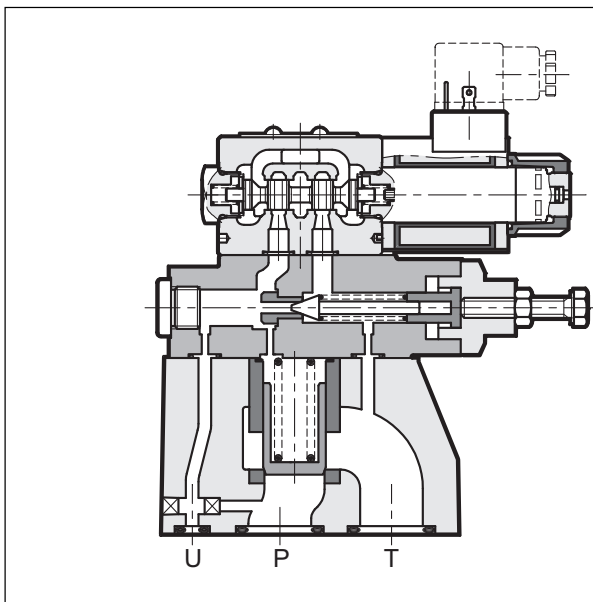

- The RQM\*-P valves are pressure relief valves available in three nominal sizes for flow up to 500 l/min.
- They are available in ISO 6264 (CETOP RP 121H) subplate mounting version.
- Available in five versions that allow, by means of a solenoid valve, unloading of the total flow and selection up to three pressure values (see table 2 Versions).
- The adjustment of the second and third pressure values is obtained by a pressure relief valve placed between the main stage and the solenoid valve.
- It is normally supplied with a hexagonal head adjustment screw. Upon request, it can be equipped with a SICBLOC adjustment knob on the main pressure control.

#### PERFORMANCES (measured with mineral oil of viscosity 36 cSt at 50°C)

		RQM3-P	RQM5-P	RQM7-P
Maximum operating pressure	bar	350		
Maximum flow rate	l/min	200	400	500
Ambient temperature range	°C	-20 / +50		
Fluid temperature range	°C	-20 / +80		
Fluid viscosity range	cSt	10 ÷ 400		
Fluid contamination degree		According to ISO 4406:1999 class 20/18/15		
Recommended viscosity	cSt	25		

**NOTE:** for the solenoid valve DS3 characteristics see catalogue 41 150



# RQM\*-P

## SERIES 60

### 1 - IDENTIFICATION CODE

<b>R</b>	<b>Q</b>	<b>M</b>	<b>-</b>	<b>P</b>	<b>/</b>	<b>/</b>	<b>/</b>	<b>60</b>	<b>-</b>	<b>K1</b>	<b>/</b>
----------	----------	----------	----------	----------	----------	----------	----------	-----------	----------	-----------	----------

pilot operated pressure relief valve  
solenoid valve for unloading / pressure selection

Size: **3** = ISO 6264-06 (CETOP R06)  
**5** = ISO 6264-08 (CETOP R08)  
**7** = ISO 6264-10 (CETOP R10)

Subplate mounting

Pressure adjustment range: \_\_\_\_\_  
**3** = up to 70 bar    **6** = up to 350 bar  
**5** = up to 210 bar

Versions: **A** } see description  
**B** } in hydraulic symbols  
**C** } table  
**D** }  
**G** }

**M** = adjustment with SICBLOC knob available only on the main pressure control (Omit for adjustment with hexagonal head screw)

Series No. (the overall and mounting dimensions remain unchanged from 60 to 69)

Manual override: omit for override integrated in the tube (**standard**)  
**CM** = manual override, boot protected

Coil electrical connection: plug for connector type DIN 43650 (**standard**)

DC power supply  
**D12** = 12 V  
**D24** = 24 V  
**D48** = 48 V  
**D110** = 110 V  
**D220** = 220 V  
**D00** = valve without coils (see note)

AC power supply  
**A24** = 24 V - 50 Hz  
**A48** = 48 V - 50 Hz  
**A110** = 110 V - 50 Hz / 120 V - 60 Hz  
**A230** = 230 V - 50 Hz / 240 V - 60 Hz  
**A00** = valve without coils (see note)

**F110** = 110 V - 60 Hz  
**F220** = 220 V - 60 Hz

Seals:  
**N** = NBR seals for mineral oil (**standard**)  
**V** = FPM seals for special fluids

**NOTE:** The locking rings of the coils and the relevant O-Rings are supplied together with valves

### 2 - VERSIONS

RQM*-P*/A	RQM*-P*/B	RQM*-P*/C	RQM*-P*/D	RQM*-P*/G
<p><b>1</b> pressure setting and unloading with de-energized solenoid</p>	<p><b>1</b> pressure setting and unloading with energized solenoid</p>	<p><b>2</b> pressure settings The highest setting is reached with energized solenoid</p>	<p><b>2</b> pressure settings and unloading with de-energized solenoids</p>	<p><b>3</b> pressure settings The highest setting is reached with de-energized solenoids</p>

### 3 - CHARACTERISTIC CURVES (values obtained with viscosity of 36 cSt at 50°C)

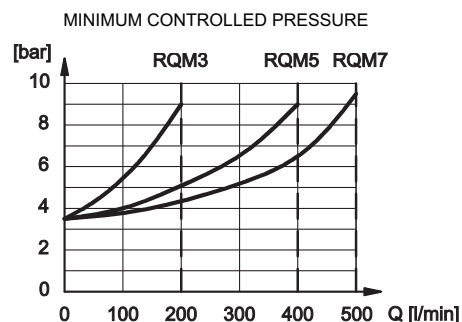
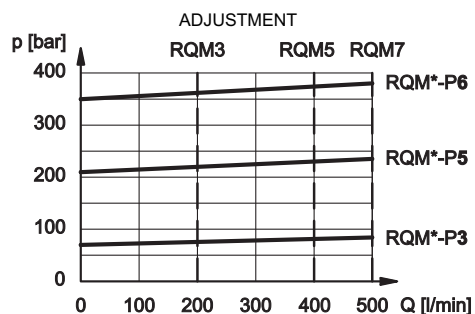



### 4 - HYDRAULIC FLUIDS

Use mineral oil-based hydraulic fluids HL or HM type, according to ISO 6743-4. For these fluids, use NBR seals (code N). For fluids HFDR type (phosphate esters) use FPM seals (code V). For the use of other kinds of fluid such as HFA, HFB, HFC, please consult our technical department. Using fluids at temperatures higher than 80 °C causes a faster degradation of the fluid and of the seals characteristics. The fluid must be preserved in its physical and chemical characteristics.

### 5 - OVERALL AND MOUNTING DIMENSIONS

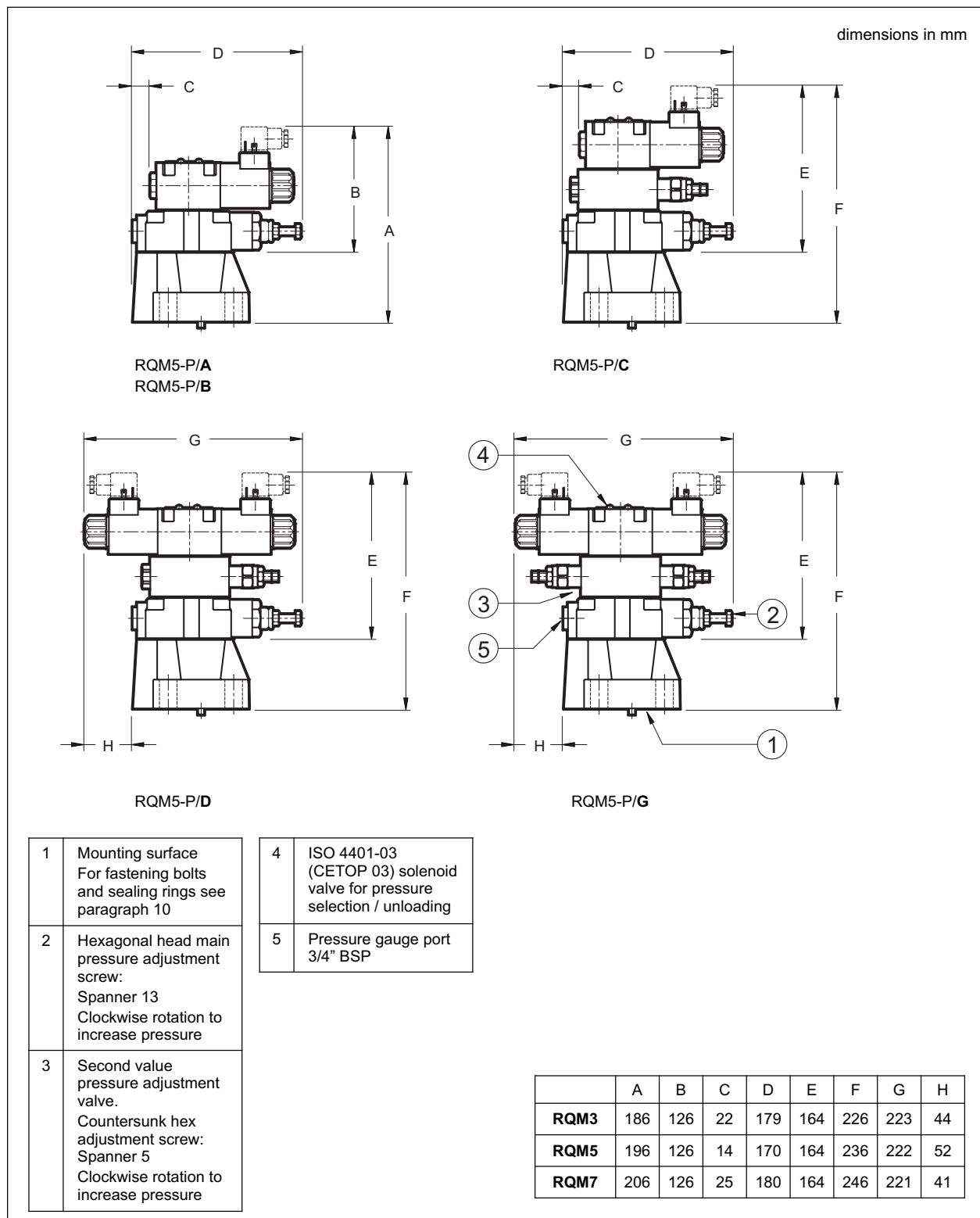



# RQM\*-P

## SERIES 60

### 6 - MOUNTING INTERFACES

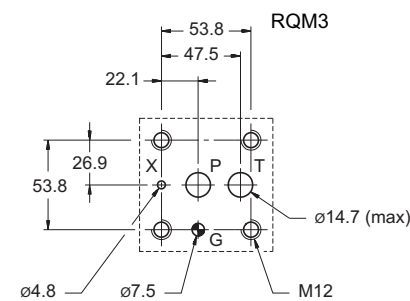

ISO 6264-06-09-\*97 (CETOP 4.4.2-2-R06-350)

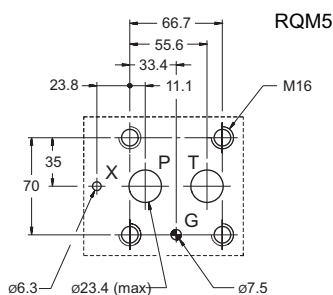

ISO 6264-08-13-\*97 (CETOP 4.4.2-2-R08-350)

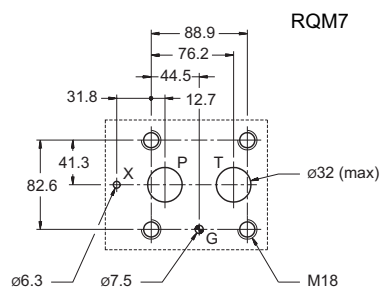

ISO 6264-10-17-\*97 (CETOP 4.4.2-2-R10-350)

### 7 - ADJUSTMENT KNOB

The RQ valves can be equipped with a SICBLOC adjustment knob, only on the main pressure regulation.

To operate it, push and rotate at the same time. To request this option, add: /M (see paragraph 1).

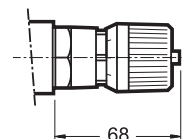

### 8 - ELECTRIC CONNECTORS

The solenoid valves are never supplied with connector.

Connectors must be ordered separately.

For the identification of the connector type to be ordered, please see catalogue 49 000.

### 9 - MANUAL OVERRIDE, BOOT PROTECTED: CM

Whenever the solenoid valve installation may involve exposure to atmospheric agents or utilization in tropical climates, use of the manual override, boot protected is recommended. Add the suffix **CM** to request this device (see paragraph 1).

For overall dimensions see catalogue 41 150.

### 10 - FASTENING BOLTS AND SEALING RINGS

	RQM3-P	RQM5	RQM7
Fastening (4 bolts)	M12 x 40	M16 x 50	M18 x 60
Torque	69 Nm	170 Nm	235 Nm
Sealing rings	2 OR type 123 1 OR type 109	2 OR type 3118 1 OR type 109	2 OR type 4137 1 OR type 109

### 11 - SUBPLATES (see catalogue 51 000)

	RQM3-P	RQM5-P	RQM7-P
Type	PMRQ3-AI4G rear ports	PMRQ5-AI5G rear ports	PMRQ7-AI7G rear ports
PT port dimensions	1/2" BSP	1" BSP	1" 1/4 BSP
X port dimensions	1/4" BSP	1/4" BSP	1/4" BSP

	<p><b>DIPLOMATIC OLEODINAMICA SpA</b>          20025 LEGNANO (MI) - P.le Bozzi, 1 / Via Edison          Tel. 0331/472111 - Fax 0331/548328</p>
--	--